



Minnesota  
Department of  
Transportation

# Value Increase and Value Capture: The Case of TH-610 in Maple Grove, Minnesota

**RESEARCH  
SERVICES  
&  
LIBRARY**

**Office of  
Transportation  
System  
Management**

Zhirong Jerry Zhao, Principal Investigator  
Hubert H. Humphrey School of Public Affairs  
University of Minnesota

**January 2014**

Research Project  
Final Report 2014-03



To request this document in an alternative format call [651-366-4718](tel:651-366-4718) or [1-800-657-3774](tel:1-800-657-3774) (Greater Minnesota) or email your request to [ADArequest.dot@state.mn.us](mailto:ADArequest.dot@state.mn.us). Please request at least one week in advance.

## Technical Report Documentation Page

1. Report No. 2014-03	2.	3. Recipients Accession No.	
4. Title and Subtitle Value Increase and Value Capture: The Case of TH-610 in Maple Grove, Minnesota		5. Report Date January 2014	
		6.	
7. Author(s) Zhirong Jerry Zhao		8. Performing Organization Report No.	
9. Performing Organization Name and Address Hubert H. Humphrey School of Public Affairs University of Minnesota 301 19th Ave S Minneapolis, MN 55455		10. Project/Task/Work Unit No. CTS Project # 2013006	
		11. Contract (C) or Grant (G) No. (C) 99008 (WO) 52	
12. Sponsoring Organization Name and Address Minnesota Department of Transportation Research Services & Library 395 John Ireland Boulevard, MS 330 St. Paul, MN 55155		13. Type of Report and Period Covered Final Report	
		14. Sponsoring Agency Code	
15. Supplementary Notes <a href="http://www.lrrb.org/pdf/201403.pdf">http://www.lrrb.org/pdf/201403.pdf</a>			
16. Abstract (Limit: 250 words)  As a natural extension of University of Minnesota value capture study in 2009, this project demonstrates the application of value-capture strategies to supplement transportation funding for the completion of TH-610 in Maple Grove, Minnesota. Using spatial and regression analysis, we estimate that the completion of TH-610, with two additional exits, would lead to a significant growth in assessed property value, including about \$12 million in land value and \$5 million in buildings. The growth would result in about \$4.3 million in property tax capacity, and about \$1 million in annual property tax revenue. With multiple scenarios of hypothetical value-capture designs, we estimate the revenue potential of value capture would range from about \$12 million to about \$37 million, which could be used to supplement project finance to expedite the completion of TH-610.			
17. Document Analysis/Descriptors Transportation, Value capture, Property assessment, Finance		18. Availability Statement No restrictions. Document available from: National Technical Information Services, Alexandria, VA 22312	
19. Security Class (this report) Unclassified	20. Security Class (this page) Unclassified	21. No. of Pages 36	22. Price

# **Value Increase and Value Capture: The Case of TH-610 in Maple Grove, Minnesota**

## **Final Report**

*Prepared by:*

Zhirong Jerry Zhao  
Hubert H. Humphrey School of Public Affairs  
University of Minnesota

**January 2014**

*Published by:*

Minnesota Department of Transportation  
Research Services & Library  
395 Ireland Boulevard, MS 330  
St. Paul, MN 55155

This report represents the results of research conducted by the author and does not necessarily represent the views or policies of the Minnesota Department of Transportation or the University of Minnesota. This report does not contain a standard of specified technique.

The author, The Minnesota Department of Transportation, and the University of Minnesota do not endorse products or manufacturers. Any trade or manufacturers' names that may appear herein do so solely because they are considered essential to this report.

## **Acknowledgments**

It has been delightful for me to work on this project. I am indebted to many colleagues in the Minnesota Department of Transportation and the Minnesota Metropolitan Council. First, I want to express my gratitude to Brad Larsen, without whom I will not have noticed this research opportunity. Next, thanks particularly to Matt Shands, Nicole Peterson, and Alan Rindels, who served as Technical Liaisons for this project. Last but not least, I want to thank all members of the Technical Advisory Panel, which also includes Philip Barnes, Ramankutty Kannankutty, John Wilson, Kenneth Buckeye, and Jonathan Ehrlich, for their kind support and indispensable advice throughout the project.

## Table of Contents

Chapter 1. Introduction .....	1
Chapter 2. Literature Review .....	3
2.1 Special Assessments (SA).....	5
2.2 Tax Increment Financing (TIF) .....	6
2.3 Joint Development (JD) .....	7
2.4 Development Impact Fees (DIF) .....	8
Chapter 3. Context, Data and Research Methods .....	10
Chapter 4. Visualizing Present and Historical Property Values .....	12
Chapter 5. Exploring the Links Between Locational Factors and Property Values .....	14
Chapter 6. Estimating the Highway Premium .....	18
Chapter 7. Projecting Property Value Changes After TH-610 Completion .....	21
Chapter 8. Calculating Value Capture Potential .....	23
Scenario 1: Tax-Increment Financing.....	24
Scenario 2: Special Assessments .....	24
Scenario 3: Special Assessments + Joint Development.....	24
Scenario 4: Special Assessments + Development Impact Fees.....	24
Chapter 9. Conclusion.....	26
References.....	27

## List of Tables

Table 2-1: Value Capture in the General Framework of Transportation Finance .....	4
Table 6-1: Description of Variables.....	18
Table 6-2: Property Values and Locational Factors: Summary Descriptives (2012) .....	19
Table 6-3: Property Values and Locational Factors: Estimated Results (2012).....	19
Table 8-1: Land Use and Tax Status within the Impact Zone .....	24
Table 8-2: Revenue Potential of Multiple Value Capture Scenarios .....	25

## List of Figures

Figure 1-1: Trunk Highway TH-610 in Maple Grove, Minnesota .....	2
Figure 3-1: The Study Area and the Uncompleted Th-610 Segment .....	11
Figure 4-1: Estimated Market Value (\$/Acre), 2006 .....	12
Figure 4-2: Estimated Market Value (\$/Acre), 2012 .....	13
Figure 5-1: Three-layer Buffers of Water Bodies.....	14
Figure 5-2: Three-layer Buffers of Open Space .....	14
Figure 5-3: Three-layer Buffers of Railway .....	15
Figure 5-4: Five-layer Buffers of Transit Stops.....	16
Figure 5-5: Five-layer Buffers of Existing Highway exits .....	16
Figure 7-1: Five-layer Buffers of Highway Exits after TH-610 Completion .....	21
Figure 7-2: Projected EMV Increase after TH-610 Completion .....	21
Figure 8-1: Land Use in the Impact Zone.....	23

## Executive Summary

As a natural extension to the University of Minnesota value capture study conducted in 2009, this project demonstrates the application of value-capture strategies to supplement transportation funding for a highway project. Within the study area of Maple Grove, it is expected that the completion of TH-610, with enhanced accessibility from gaining additional highway exits, could significantly promote development activities nearby, and contribute to Maple Grove's property tax base. This study is conducted to estimate the increase in value associated with the project's completion and assess the revenue potential associated with multiple value-capture schemes. We defined a study area of about 10 square miles surrounding the unfinished TH-610 segment, and modeled property values based on five locational factors with parcel-level data from 2012. The estimated results provide significant evidence of a "Highway Premium." That is, parcels adjacent to the highway exits tend to have much higher assessed property values than parcels farther away from highway exits, and the difference is more in land values than for buildings. For example, for parcels within a 0.1 km radius of highway exits, the premium on estimated market value (EMV) of land is \$45,080 per acre (significant at the 0.01 level), while the premium on EMV of buildings is \$20,370 per acre (not significant).

Applying these model estimates, we expect that the completion of TH-610, with two additional exits, will lead to about \$11,928,000 in the growth of estimated market value for land (EMV\_LAND) and about \$5,390,000 in the growth of estimated market value for buildings (EMV\_BLDG) within the study area. Adding the two together, about \$17,318,000 would be the growth of total estimated property value (EMV\_TOTAL), resulting in about \$4,267,000 in property tax capacity and about \$996,000 in property tax contribution. With multiple scenarios of hypothetical valued-capture designs, we estimate the revenue potential of value capture ranges from about \$12 million to about \$37 million that could be used to supplement project financing to expedite the completion of TH-610.

This research will have significant benefits for the TH-610 project and beyond. The primary end users of the research include MnDOT and its local partners in highway development, but the knowledge gained can benefit other states as well. If the value-capture schemes were implemented, they could generate additional funding to supplement the construction of TH-610, and accelerate the completion of the project. Even if the results were not used to help fund and accelerate TH-610 completion, the research demonstrates a way to estimate the value of transportation improvement and to communicate that to the public. Such research could greatly assist MnDOT, as well as local governments and other transportation stakeholders, to make informed decisions and engage in joint efforts in transportation investment.



## Chapter 1. Introduction

In recent years—with the growing realization that the cost of maintaining and improving the transportation system will not be met by existing financing and revenue generation methods—US government at all levels are searching for new methods to pay for improving and/or replacing the present system, one of which is value capture (National Surface Transportation Policy and Revenue Study Commission, 2007). The current US transportation funding system emphasizes user fees. Value capture is a different strategy that aims to recover the value of benefits received by property owners and developers due to infrastructure improvements by using the revenue to fund such improvements (Zhao and Levinson, 2012).

In 2009, a research team at the University of Minnesota completed a report, “Value Capture for Transportation Finance.” The project identified eight potential strategies that could be used to supplement funding for transportation infrastructure investments (Iacono *et al.*, 2009). Since the University of Minnesota report was published, value capture as a supplemental transportation finance method has received increased attention in Minnesota and elsewhere. Additionally, two recent MnDOT research projects continued the discussion. In a research report on advancing public-private-partnerships (PPP) in state highway development (Zhao, 2011), value capture is identified as one category of PPP that could provide additional funding for transportation development. In a consulting report prepared by HNTB Corporation for MnDOT, value-capture tools were briefly discussed as potential ways to provide additional funding for the St. Croix Crossing Project (HNTB 2011). This project is a natural extension of the 2009 University of Minnesota’s value-capture study. It demonstrates the potential effects of using value-capture strategies in a Minnesota highway project.

Figure 1-1 shows the context of this research project. The City of Maple Grove is located to the northwest of the Minneapolis-St. Paul Twin Cities region. With its population growing more than 30% since a decade ago, Maple Grove was featured by the Bloomberg Businessweek as one of America’s Fastest-Growing Cities in 2010 (Businessweek 2010). In the northern part of the City, however, a stretch of Trunk Highway TH-610 has been delayed for years due to a MnDOT funding shortage. It is anticipated that the completion of TH-610, with its enhanced accessibility due to the addition of highway exits, would promote significant development of adjacent areas and contribute to Maple Grove’s property tax base. Typically trunk highway funding is provided solely by MnDOT and any enhanced value that comes from transportation improvements are either “windfalls” enjoyed by property owners and developers who gain locational advantages or to a lesser extent they are property tax increments gained by local government. If the benefits of value-capture strategies were clearly demonstrated to the general public, the additional generated revenue could supplement highway funding and expedite the completion of Trunk Highway TH-610. This project aims to: (1) model the impact of highway accessibility on property values in the area, (2) predict the increase in the property tax base after the completion of TH-610, and (3) project the revenue potential associated with various value-capture strategies.



**Figure 1-1: Trunk Highway TH-610 in Maple Grove, Minnesota**

This report is organized as follows. Chapter 2 succinctly reviews the value-capture literature and focuses primarily on the value-capture strategies previously identified in the University of Minnesota research. Chapter 3 introduces the study area, data, and research methods. Chapter 4 examines the impact of highway accessibility on property tax values in the study area, holding other locational features constant. Chapter 5 applies the estimated highway accessibility premium to predict future property tax growth, and projects the revenue potential associated with different value-capture strategies.

## Chapter 2. Literature Review

To better understand the rationale of value capture, it is helpful to compare the policy tool to other transportation finance options, for instance, in a general framework of transport finance proposed by the University of Minnesota value-capture research published in 2009 (Zhao and Levinson, 2012). Following the benefit principle that the cost of transportation for a contributor should be proportional to the benefits received, different instruments could be designed to match different categories of benefits and the different ways these benefits are measured. As Table 2-1 shows, these benefits fall under three broad categories of beneficiaries: unrestricted general public; restricted non-user beneficiaries; and direct users of transportation facilities.

In the broadest sense, transport improvements create benefits for the general public within the entire jurisdiction, because the enhanced infrastructure could lead to economic or social returns signified by the growth of the general tax base. Accordingly, transport could be given allocations from a government general fund that comes from all revenue sources. This is typically the case for local governments in the United States and many other countries. Most directly, transport benefits are enjoyed by users, such as vehicle operators or transit passengers. This observation provides the rationale of dedicated special revenues for transportation. For vehicle operators, the corresponding financial instruments are gas taxes, distance-based (mileage) charges, vehicle sales taxes or vehicle property taxes, wheelage charges, or tolls, depending on how driving benefits are measured. Some options, such as gas taxes or vehicle sales taxes, have been widely used by the US federal government and the states.

Between the general public and direct users of facilities, we define a restricted group of non-user beneficiaries who enjoy benefits because of their enhanced location advantages. As these landowners and developers benefit from transport value creation, they are the targeted contributors of value capture. Different ways to measure the value gains give rise to a range of different value capture policies, which may be categorized in two groups (Iacono *et al.*, 2009). Aiming to capture increased property values due to infrastructure improvements, the first group includes land value taxation (discussed in two papers in this issue), special assessment financing (Zhao and Larson, 2011), tax increment financing (Zhao and Das, 2010), transportation utility fees (also discussed herein); aiming to capture the value of enhanced development rights, the second group includes negotiated exactions (Altshuler, Gómez-Ibáñez, and Howitt, 1993; Been, 2010), development impact fees (Jung, Roh and Kang, 2009; Mullen, 2008), joint development (Zhao, Das and Larson 2012), and air rights development (King, Krizek and Levinson, 2008).

**Table 2-1: Value Capture in the General Framework of Transportation Finance**

Funding Mechanism	Beneficiaries		Measurement of Benefit	Finance Instrument	Cost Type	
					Upfront	Ongoing
<b>General Revenue</b>	General public		General tax base growth	General fund allocation; property tax; transportation sales tax	●	●
<b>Value Capture</b>	Restricted non-user beneficiaries	Landowners	Land value growth	Land Value Taxes	●	●
			Property tax growth	Tax Increment Financing	●	
			Assessed special benefits	Special Assessment	●	
			Transportation utility	Transportation Utility Fees		●
	Developers	Off-site development opportunities	Development Impact Fees	●		
		Off-site access benefits	Negotiated Exactions	●	●	
		Development privileges	Joint Development	●	●	
		On-site development opportunities	Air Rights	●	●	
<b>User Fees</b>	Users of transportation facilities	Vehicle operators	Gas consumption	Gas taxes	●	●
			Mileage	Mileage-based charges	●	●
			Vehicle units/types	Vehicle sales tax; license tab fee; wheelage charges	●	●
		General access rights	Tolling		●	
		Demand-controlled access rights	Congestion pricing		●	
		Rights to incur environmental impacts	Transportation environmental taxes/fees		●	
	Passengers	Ridership	Fare or permits		●	

Source: Zhao and Levinson (2012).

Among the eight value-capture strategies identified by the University of Minnesota research, in this chapter we briefly discuss four with potential applications to this project. These value-capture strategies include special assessments (SA), tax increment financing (TIF), joint development (JD), and development impact fees (DIF). The four strategies not discussed are land value taxes, transportation utility fees, negotiated exactions, and air rights. Land value taxes and transportation utility fees are typically applied to a whole jurisdiction and are less applicable to a selected area. Negotiated exactions are used to acquire transportation right-of-ways. Air rights are feasible only in areas where there are high-density development and high demands for land.

The rest of this chapter explains these four strategies, discusses relevant experiences, and examines their efficacy as transportation finance instruments in the State of Minnesota. The descriptions and analysis are mainly derived from the 2009 Value Capture study funded by the

Minnesota Legislature (Iacono *et al.*, 2009). In particular, the four value-capture strategies are evaluated against four criteria: economic efficiency, equity, revenue adequacy, and feasibility (Zhao, Das and Becker, 2009). Sample questions are:

- **Economic efficiency:** Is the cost to contributors related to the benefits they receive? Will the strategy provide incentives for travelers, investors, or government units? Will it hinder economic development?
- **Equity:** Is the strategy fair? Are there equity issues in terms of geography? How does it affect different income groups?
- **Revenue adequacy:** Is the revenue base broad or narrow? Is the tax rate high or low? How much revenue can it raise? Would it be enough to replace traditional sources of revenue? To what extent could the revenue catch up with income growth, inflation, and need? Is it stable or cyclical? Is it predictable?
- **Feasibility:** Is it visible to taxpayers? How do developers and the public perceive it? How hard is it to manage the process and are additional skills needed?

## 2.1 Special Assessments (SA)

*Special assessments* (SA) impose special charges on property close to a new facility. The assessment is levied only against those parcels that received a special benefit that can be clearly identified and measured. Various methods have been used to determine which properties receive special benefit and to allocate charges among these beneficiaries. Some of these methods include measuring the distance from an improved facility, whether the property frontage is adjacent to an improved facility, and property acreage (Zhao and Larson, 2011).

In rural areas, SA are often used for road improvements under the formation of “rural improvement districts.” In urban areas, SA are widely used for road improvements and increasingly used for improvements to public transit networks. Recent streetcar and light rail transit projects in cities like Seattle and Portland have involved the authorization and formation of “local improvement districts,” within which special assessments are levied to finance a portion of capital costs. Other U.S. cities that are exploring SA for similar types of projects include Atlanta, Washington, DC, Minneapolis, Tampa, and Columbus.

Depending on the type of mechanisms used to set the charge (acreage, frontage, distance, etc.), the use of SA to apportion cost of a transportation improvement among its more direct beneficiaries can enhance economic efficiency. SA could promote economic development that help finance needed improvements that provide net benefits to local landowners. SA improve benefit-received equity in that they assign costs for a transportation improvement to local property owners in proportion to the benefits received. Regarding the ability-to-pay principle, SA tend to be regressive in that they place higher effective tax burdens on lower-income households. However, the level of regressivity can be reduced with modifications to allow for

discounts, tax credits, exemptions, or other forms of relief for the elderly, low-income, or other vulnerable groups.

Given the location-specific nature of the mechanism, SA typically have a narrow base and raise a limited amount of revenue. They are not a large-scale replacement for more conventional transportation revenue sources. For specific projects, however, SA could provide a significant portion of capital cost. In rural improvement districts, adjoining property owners typically pay for the entire cost of the improvement. For transit projects from streetcars to subways, depending on the level of local support for the project and the willingness of local property owners to tax themselves, SA could provide up to half of the capital cost.

SA are highly visible to affected property owners and are viewed as skeptically as the increase of property tax. Local landowners, business leaders, and public officials need to be convinced of the value and necessity of adopting SA as an instrument of transportation finance before the charges become politically feasible. Administratively, SA districts are somewhat difficult to establish, as they must identify legally defensible methods of calculating assessments. Once in place, however, SA are relatively easy to administer and can be implemented along with current property tax.

In Minnesota, SA are currently limited to local governments and are not authorized for application to interstate highways. Allowing the establishment of SA for transportation purposes would require amendment of state statutes to allow state and regional agencies as authorized users and to allow SA to be applied to interstate highways and public transportation facilities.

## **2.2 Tax Increment Financing (TIF)**

*Tax increment financing* levies taxes on the future increment in property value within a development (or redevelopment) project to finance infrastructure improvements (Zhao and Das, 2010). TIF is commonly used by local governments to promote housing, economic development, and urban redevelopment in established neighborhoods. TIF has been used, however, in some instances to finance transportation projects, especially public transit. In Chicago, TIF districts have been established to support the construction of subway/elevated stations near the central business district. Portland, Oregon has used TIF to support the Central City Streetcar Project and the Interstate Avenue Light Rail.

The ability of TIF to capture value for transportation finance largely depends on its ability to support projects that deliver large, local benefits in property value appreciation. Evidence from Chicago suggests that the increment in property value that can be captured from subway station improvements may be large. However, the same results could be hard to achieve for more recent applications to streetcar and light rail projects in Portland and Seattle, because subway systems operate at higher average speeds and serve more densely populated locations than streetcar and light rail networks. Moreover, the ability of TIF to promote economic development is limited if the growth of property values within a TIF district comes at the expense of growth elsewhere.

TIF promotes benefit-received equity. Requiring those who receive disproportionate benefit from a transportation improvement to make a greater contribution towards financing the improvement, not only promotes economic efficiency, but also promotes fairness in distributing the burden of transportation finance. However, the abuse of TIF in some jurisdictions has led to concerns about TIF being “corporate handouts” or a means to channel subsidy funds to

counties and school districts) may not share the benefit from a TIF district. TIF could be limited to specific projects and one-time capital costs.

TIF has a limited revenue-raising capacity and is not a good candidate for completely replacing existing transportation revenues. As a project-specific financing tool, however, they could replace a significant share of general revenue sources for specific projects. TIF revenues are relatively stable in that properties within a TIF district rise at above-average rates.

TIF does not involve tax rate increases and thus possesses low political visibility. The perception that TIF financed projects “pay their own way” could mute local opposition and increase public acceptance. TIF is also popular among developers, as it allows development projects to move forward that could be stalled due to insufficient infrastructure. The establishment of TIF districts requires much effort from administrative staff in adopting jurisdictions, especially in ensuring that legal requirements such as needs assessments are met. Once TIF districts are established, however, enforcement and compliance costs typically come from the same levels associated with regular property tax collection. In some states, the authorizing statute needs to be amended to allow state agencies as authorized users of TIF.

### **2.3 Joint Development (JD)**

*Joint development* refers to the development of a transportation facility and adjacent private real estate development, in which a private sector partner either provides the facility or makes a financial contribution to offset its costs. We can divide JD agreements into two types of ownership structures, depending on whether the property and development rights are owned publicly or privately. Another way to classify JD arrangements is to specify whether the agreements involve revenue-sharing or cost-sharing between the public and private sector participants. In revenue-sharing arrangements, the infrastructure provider, typically a public entity, may retain a share of the revenues from new development near the improved facility. Cost-sharing arrangements, on the other hand, involve private sector participation in the provision or maintenance of the infrastructure itself (Zhao, Das and Larson, 2012).

Both land development and infrastructure provision may be conducted by the public or private sector, or jointly by both sectors. Jointness refers to simultaneous and integrated infrastructure and development. However, it may also involve different parties (public, private, and combinations). There are many variations of joint development as long as the infrastructure and land development are simultaneously coordinated (and geographically proximate).

The adoption of JD arrangements has been more common abroad, with several prominent examples in large, eastern Asian cities such as Hong Kong and Tokyo. These cities boast extensive railway systems, where expansion is often tied to new real estate development through financial arrangements that involve the sale or lease of newly-developed properties near the rail stations. U.S. JD experiences are more limited but still illustrate the application of value-capture strategies. For example, in Portland, Oregon, a private development team agreed to contribute a small share of the capital costs for constructing a light rail link between Portland’s central business district and the City’s airport, in exchange for the rights to develop a large and vacant property near the airport. Washington Metropolitan Area Transit Authority (WMATA) has also engaged in JD at selected Metrorail stations. Experience of JD with highways has been less common, as highway agencies have traditionally not been permitted to acquire excess real estate,

beyond what was required for transportation purposes, and the value of air rights over highways has been less valuable than air rights over transit stations. However, in projects—like the Dulles Greenway and other Public Private Partnerships—building highways are also a form of JD.

JD arrangements generally promote economic efficiency, as the voluntary nature of the transaction ensures that the expected benefits of the private sector partner exceed the cost (or share of costs) of the anticipated transportation improvement. This characteristic also promotes benefit-received equity among participants. In addition, JD projects often attract higher-end office and commercial tenants. To the extent that these tenants do not shift the costs of their contribution to lower-income customers or employees, JD financing can be proportional or progressive with respect to the ability-to-pay principle.

Since the nature of JD arrangements is often location-specific, the base is rather narrow. The amount of revenue generated is relatively small and unlikely to completely replace more traditional sources of revenue. JD agreements can be structured to provide secure upfront payments applied toward the capital cost of an improvement, or to ensure a stable and reliable stream of revenues for future years. Alternatively, payments could be structured to rise with income or general price levels if these criteria were deemed desirable.

The narrow base and low visibility of JD revenues make them politically palatable to most residents. This is especially true if residents believe that this source of finance may allow the cost of providing transportation services to be exported to non-residents. With respect to developers, JD arrangements are only undertaken when the private sector anticipates an incremental benefit, meaning that JD will not be feasible in every situation. JD agreements are administratively more complex than more conventional sources of revenue. They tend to involve high transaction costs, and require more sophisticated legal, marketing, financial, and other types of specialized skills. In Minnesota, JD are currently authorized under current statutes for public-private partnerships.

#### **2.4 Development Impact Fees (DIF)**

Development impact fees (DIF) are similar to negotiated exactions in that they are charged primarily to new development to help recover growth-related public service costs (including infrastructure), but differ in that impact fees can be levied for off-site development activities in a defined area that might sometimes be extended to a whole jurisdiction. In addition, DIF are typically determined through formal calculations of the public service costs of new development activities, rather than through the less-formal negotiation processes typically used with negotiated exactions (Iacono *et al.*, 2009). DIF is widely used through the United States, but prior attempts to levy them in Minnesota were challenged in the courts (Mullen, 2008).

DIF can improve economic efficiency by allocating initial costs of infrastructure to those development activities likely to benefit from the infrastructure. DIF also meet the equity principle as it could be designed so that developers contribute proportionally to the benefits they could receive. DIF in general is not regressive; it does not impose a relatively greater burden on the poor than on the wealthy, unless it causes developers to abandon low- and moderate-income housing markets.



The revenue base of DIF is narrow, since impact fees are targeted often toward new development. The rates of DIF may be adjustable and thus there is good potential for revenue growth if there are active development activities. DIF are strongly tied to the demand for new housing and/or commercial space, so it is subject to cyclical movements in real estate markets and the economy more generally (Jung, Roh and Kang, 2009).

DIF are not highly visible to the public as a new revenue instrument and thus is political feasible because it is less likely to be strongly resisted by current residents. The administrative cost of DIF is fairly low, because it is easier to collect once rates have been determined. In Minnesota, specific, state-level legislation would be needed to authorize the use of DIF. To justify the levy of DIF, there must be a clear connection (nexus) between the charges imposed on a development and the public service need (or initial infrastructure requirement) of the development.

### **Chapter 3. Context, Data and Research Methods**

The context of this research is shown in Figure 3-1. We collected parcel-level data about land use and property assessments for the entire City of Maple Grove, which covers about 35 square miles. Statistical analyses are mostly conducted within a smaller study area, which covers about one third of Maple Grove to the north of Highway 30, with an area of about 10 square miles. The eastern stretch of TH-610, about 2 miles long, has been finished since 2007, and it links to Highway 169 to the east of Maple Grove. The western stretch of TH-610 that links to Interstate I-94, about 4 miles long, remains unfinished due to a funding shortage. In Figure 3-1, three blue circles indicate three existing highway exits within the study area, while two red circles indicate two new highway exits to be added upon TH-610 completion. These additional highway exits are expected to significantly improve the accessibility of adjacent properties and hence lead to sizeable amounts of property base growth. The project aims to quantify the associated value increase and to estimate the revenue potential of value capture.

Annual data at the parcel-level about land use and property assessments were collected between 2006 and 2012. These data are compiled by the Hennepin County Surveyor's Office. These data, together with GIS base maps of Maple Grove, can be accessed through the U-Spatial office, University of Minnesota. Some additional data are collected from the Metropolitan Council and the Community Geographic Information Systems (CGIS) at the Center for Urban and Regional Affairs (CURA), University of Minnesota.

The analyses include four steps. First, we used Geographic Information System (GIS) to visualize and analyzed historical property value changes within the study area. Second, we used descriptive statistics to analyze the impacts of five location factors on property values in 2012 within the study area. These five factors include three amenity factors (water body, open space, and railroad) and two accessibility factors (bus stops and highway exits). Third, we used multiple regressions to model property values based on locational factors with the 2012 data. The focus of analysis is to estimate the "Highway Premium," holding other location factors constant. Fourth, we applied the estimated model coefficient to project property value increase within the study area as a result of enhanced accessibility due to the Th-610 completion. Finally, we calculated the potential of value-capture revenues that may be generated with different value-capture strategies.

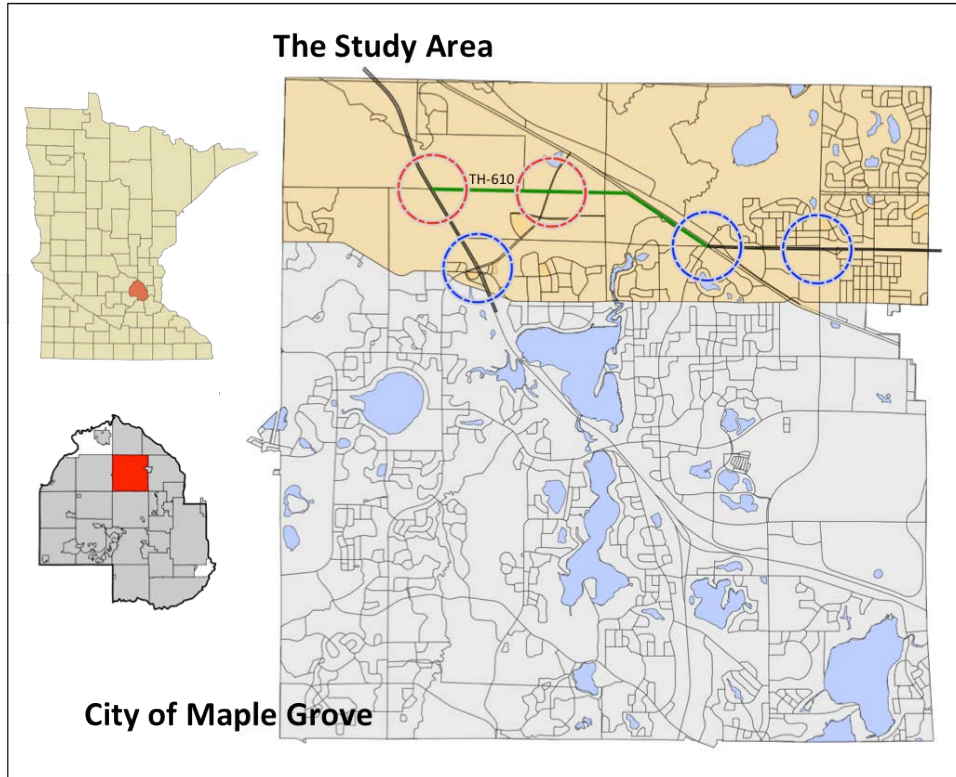
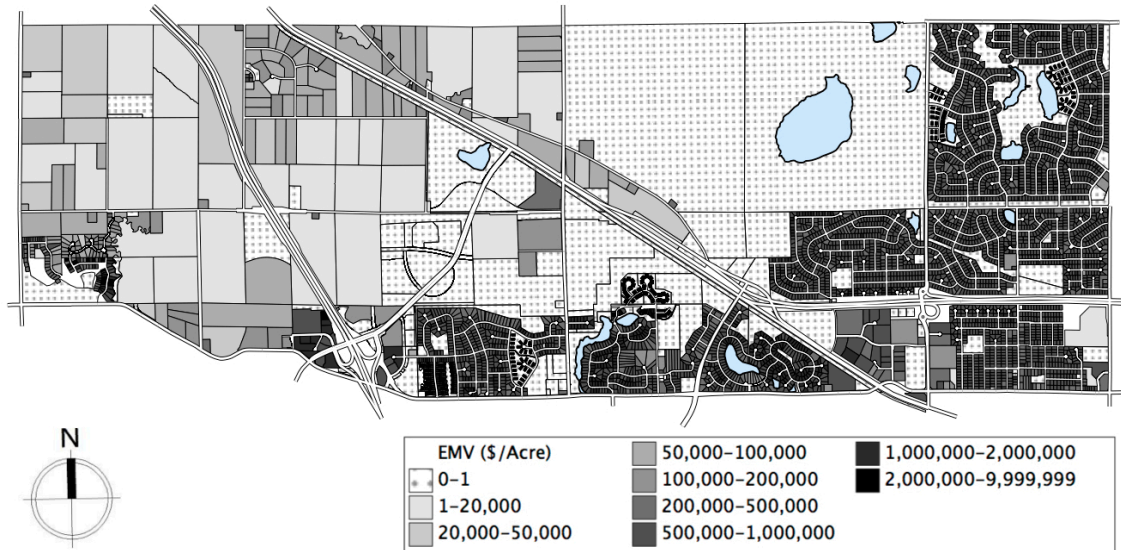

**Figure 3-1: The Study Area and the Uncompleted Th-610 Segment**  
(Blue circles indicate existing highway exits; red circles indicate new ones)

## Chapter 4. Visualizing Present and Historical Property Values

In this step, we used Geographic Information System (GIS) to visualize and analyze historical property value changes within the study area, especially the changes associated with the construction of current TH-610 segments.

Figure 4-1 shows the estimated market value (EMV) of parcels in 2006; Figure 4-2 shows EMV of parcels in 2012. Several observations stand out when visually comparing the two figures. First, higher EMV are associated with parcels in the southeast study area, where there has been more residential development. Second, in the western portion of the study area, many parcels have larger lot sizes and lower EMV per acre. These parcels are farmlands and undeveloped lands. Third, there are substantive areas of parcels, especially in the middle of the study area, that are exempt from property tax and thus do not have an EMV. Lastly, comparing the two figures, there are not significant changes of parcel values during 2006–2012, except that some originally exempt parcels in the middle of study area have been developed and converted into other usages that are no longer tax-exempt.



**Figure 4-1: Estimated Market Value (\$/Acre), 2006**

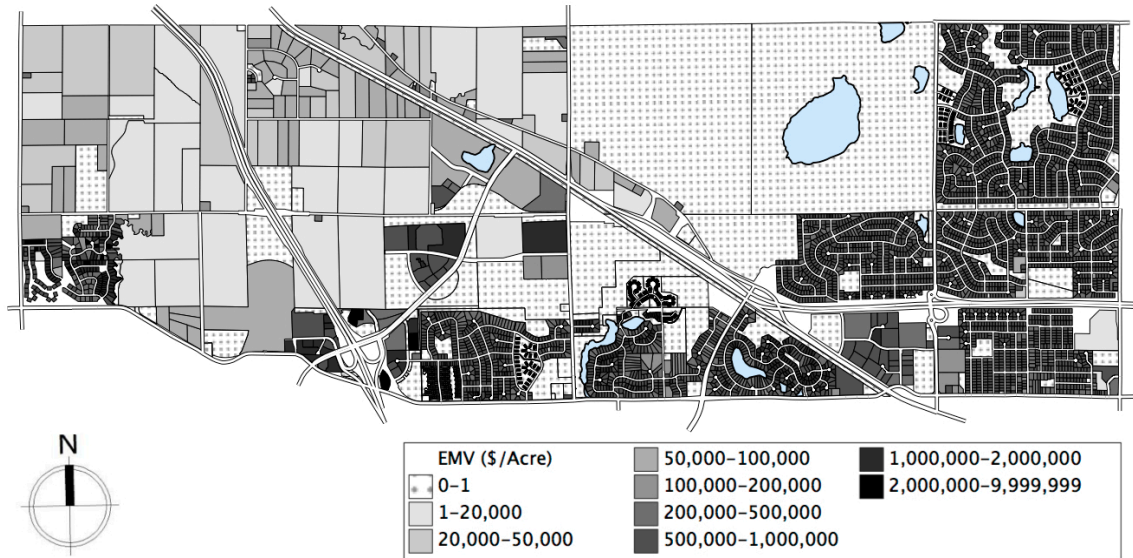

**Figure 4-2: Estimated Market Value (\$/Acre), 2012**

EMV of each parcel includes two parts, EMV\_L for land and EMV\_B for improvements (buildings). In general, average EMV per acre grows 6.03% during 2006–2012, while EMV\_L grows 16.03%. The results indicate that, during the study period, average land value has increased and more than compensates for the decrease of average improvement value, despite the housing market downturn.

Average tax capacity per acre grows 9.97% faster than the appreciation of average EMV, suggesting that more parcels have been converted from lower property-tax class rates (such as farmlands or residential properties) to higher property-tax class rates (such as business properties) than the other way around. Average property tax per acre grows about 53.46%, much faster than the increase of average tax capacity. These results indicate that average property tax rates were raised during the study period.

## Chapter 5. Exploring the Links between Locational Factors and Property Values

In this step, we analyzed five location factors that may affect property EMV in 2012 within the study area. These five factors include three amenity factors (water body, open space, and railroad) and two accessibility factors (bus stops and highway exits). We assume that amenity factors will affect property values for parcels within 0.3 km distance, with the effects inversely related to the distance from said factors. We assume that accessibility factors will affect property values for parcels within 0.5 km, and likewise with the effects inversely related to the distance from said factors.

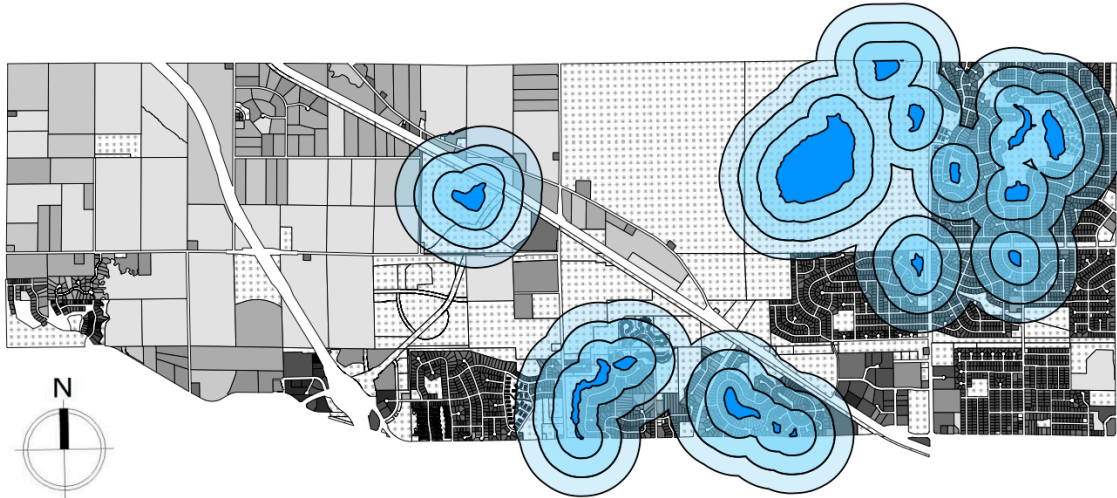

**Figure 5-1: Three-layer Buffers of Water Bodies**

Figure 5-1 shows three-layer buffers of water bodies, with each layer at a 0.1 km distance. Descriptive analysis by parcel subsets shows significant “Lakeview Premiums” for parcels with proximity to water bodies. Parcels within a 0.2km radius have an average EMV of \$670,000 per acre and contribute about \$9,600 in property tax per acre, compared to an average EMV per acre of \$335,000 and about \$6,900 in property tax per acre for all parcels within the study area.

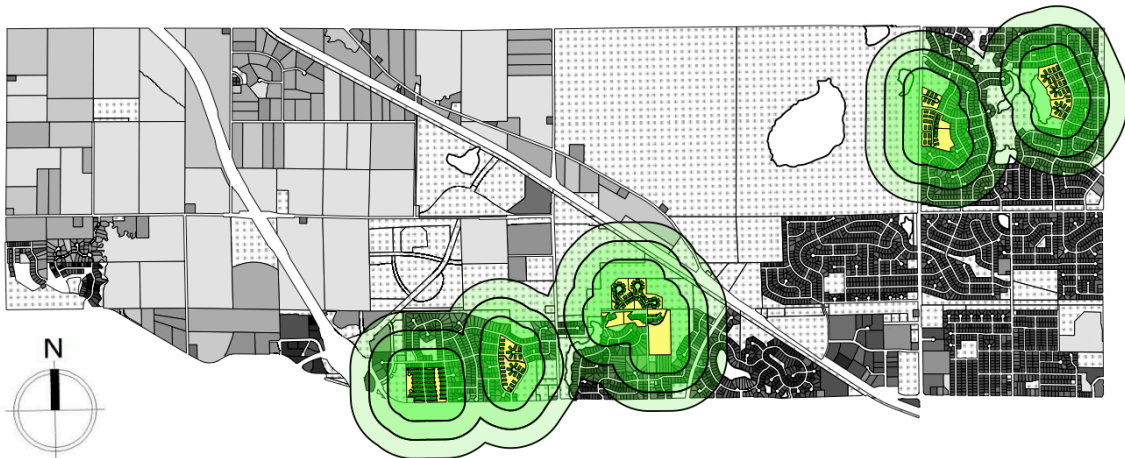

**Figure 5-2: Three-layer Buffers of Open Space**

In the study area, sometimes a collection of parcels sharing a “common land,” is exempt from property tax and thus is not assessed EMV. Such common lands provide open space for nearby property parcels that may enjoy an “Open-space Premium.”

Figure 5-2 shows three-layer buffers of common lands where each layer outside adds 0.1 km distance. Clearly, there is a positive relationship between property values and the proximity to open space. Within a 0.1 km radius, parcels have an average EMV of about \$1,000,000 per acre and contribute about \$14,000 in property tax per acre. With a distance of 0.1–0.2 km to open space, parcels have an average EMV of about \$208,000 per acre and contribute about \$13,800 in property tax per acre. As mentioned for all parcels in the study area, the average EMV is a mere \$335,000 per acre and the average property tax contribution is only \$6,900 per acre.

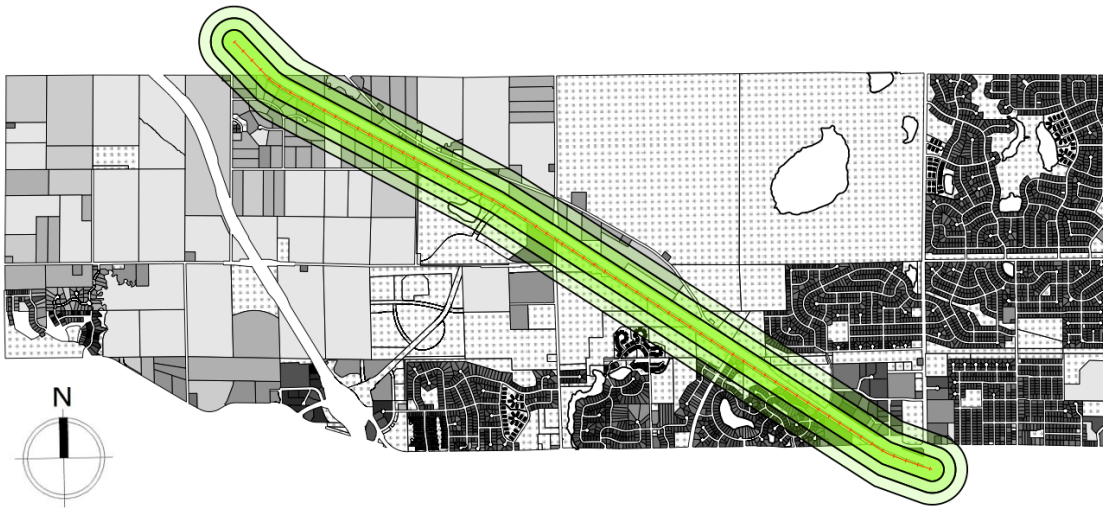

**Figure 5-3: Three-layer Buffers of Railway**

Cutting through the study area is a stretch of railway, which may have negative (nuisance) effects on property values nearby. Figure 5-3 shows three-layer buffers of the railway where each layer outside adds 0.1 km distance. Our analysis shows that within a 0.2 km radius, parcels have much lower values than the average in the study area: The EMV is \$200,000 per acre compared to the area-wide average of \$335,000; the property tax contribution is about \$6,400 compared to the area average of \$6,900.

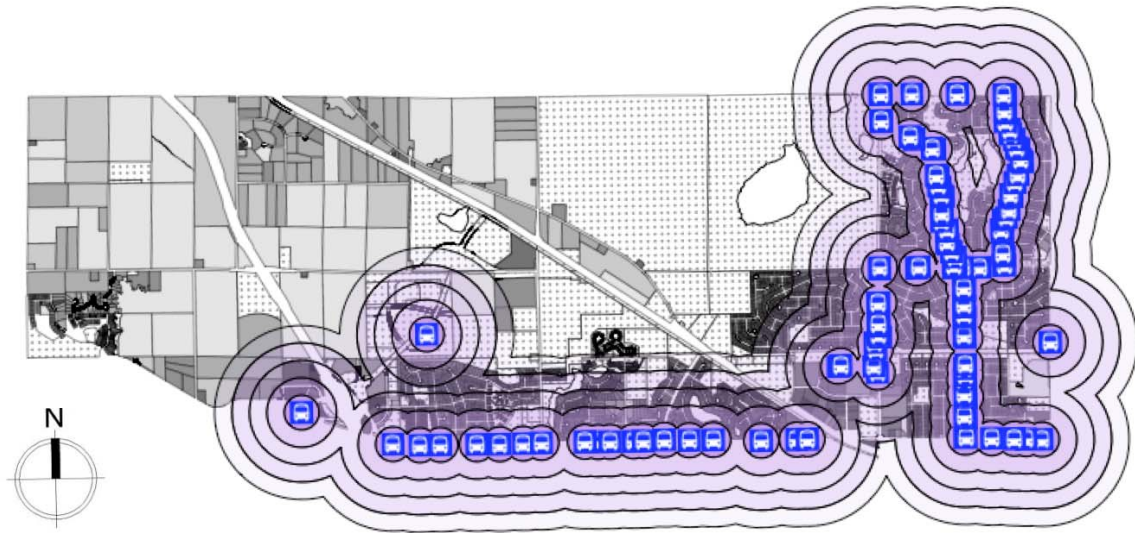

**Figure 5-4: Five-layer Buffers of Transit Stops**

In the analysis we also assess the impact of transit stops on property values. Figure 5-4 shows five-layer buffers of these transit stops, most are located in the residential areas to the east and south of the study area. Within the buffer area, we observed a negative association between proximity to transit stops and assessed values as well as property tax contribution. For example, within a 0.1km radius, per acre property tax levy is \$11,400; within the distance of 0.1–0.2km, per acre property tax levy is \$14,300; within the 0.2–0.3km zone, per acre property tax levy is \$15,600; within the 0.3–0.4km zone, per acre property tax levy is \$18,700.

These seemingly counter-intuitive results may not infer that transit stops are harmful for nearby property parcels. Note that transit stops are all along roadways. The negative association may be because the nuisance effect of being too close to roadways outweighs the convenience of being close to transit stops.

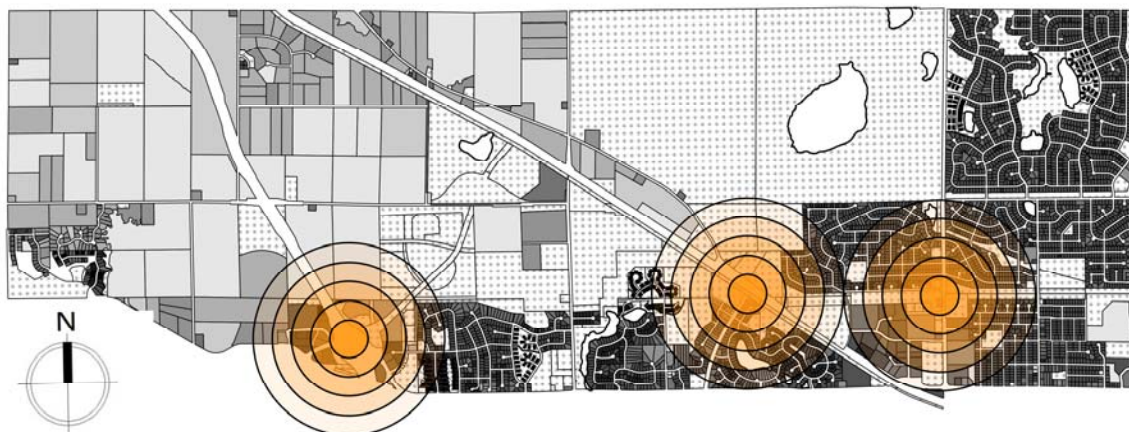

**Figure 5-5: Five-layer Buffers of Existing Highway Exits**

Lastly, we looked at the spatial association between highway exits and property values. Five-layer buffers around three existing exits are shown in Figure 5-5. Descriptive analysis illustrates



the “Highway Premium” on property values, but the relationship is not strictly linear. In general, per acre assessed values and property tax contributions are higher for parcels that are closer to the intersection. In the whole study area, property tax levy per acre is about \$6,900. It increases to \$9,000 within the 0.4–0.5km zone, \$17,500 within the 0.3–0.4km zone, \$21,900 within the 0.2–0.3km zone, and \$22,300 within the 0.1–0.2km zone. However, the values decrease significantly to about \$10,000 for parcels that are too close to the intersection point within a 0.1km radius.

## Chapter 6. Estimating the Highway Premium

In this step, we used multiple regressions to model property values based on locational factors with 2012 data. The focus of the analysis is to estimate the “Highway Premium” while holding constant other location factors. In these models, we make a strong assumption that property values are determined only by locational factors, because the purpose is to assess the impact of locational factors on property values, not to predict property values. If the purpose is to predict property values, additional variables such as lot size, land use category, and property values of adjacent parcels would be included. Additional independent variables are affected by specific parcel locations and, therefore, not included to avoid underestimating the true impact of locational factors.

These control variables include “Lake Premium,” “Open-space Premium,” “Railroad Nuisance,” and “Transit Premium,” together with two additional ones, Centroid-X and Centroid-Y, indicating the longitude and latitude, respectively. Parcels with higher Centroid-X are located further to the east and are expected to have higher property values due to the proximity to the metropolitan center. Parcels with higher Centroid-Y are located further to the north and are expected to have lower property values due to they are further away from downtown Maple Grove.

**Table 6-1: Description of Variables**

<b>EMV_LAND</b>	Estimated Market Value (EMV) for land (\$/Acre).
<b>EMV_BLDG</b>	Estimated Market Value(EMV) for building (\$/Acre).
<b>EMV_TOTAL</b>	Estimated Market Value (EMV) for land & building (\$/Acre).
<b>TAX_CAPACITY</b>	Minnesota tax capacity measured as EMV multiplied by different class rates (\$/Acre).
<b>PROP_TAX</b>	Property tax levied (\$/Acre).
<b>Lake premium</b>	Parcels within 0.3 kilometers of lakes are assumed to have value premium inversely related to their distances from lakes.
<b>Open-space Premium</b>	Parcels within 0.3 kilometers of common open-space are assumed to have value premium inversely related to their distances from open-space areas.
<b>Railroad Nuisance</b>	Parcels within 0.3 kilometers of railroad are assumed to have nuisance effects inversely related to their distances from railroad.
<b>Transit Premium</b>	Parcels within 0.5 kilometers of transit stops are assumed to have value premium inversely related to their distances from stops.
<b>Highway Premium</b>	Parcels within 0.5 kilometers of highway intersections are assumed to have value premium inversely related to their distances from intersections.
<b>Centroi- X</b>	X coordinate for the centroid of property parcels (meter). Higher values are associated with the east direction, inferring a closer distance to the Minneapolis downtown.
<b>Centroi- Y</b>	Y coordinate for the centroid of property parcels (meter). Higher values are associated with the north direction, inferring a further distance away the center of Maple Grove.

Table 6-1 provides variable descriptions. Except for Centroid-X and Centroid-Y, locational factors are coded 1 for parcels that are within a 0.1km radius, between 0 and 1 for other buffer zones with the value inversely related to their distances from the buffer center, and 0 for parcels that are out of the multilayer buffer zones. For example, within the five-layer buffer zones for

highway exits, parcels are coded 1 within a 0.1km radius, 0.8 in the 0.1-0.2km zone, 0.6 in the 0.2-0.3km zone, 0.4 in the 0.3-0.4km zone, 0.2 in the 0.4-0.5km zone, and 0 if they are out of the multilayer buffer zones. Such operationalization provides a convenient way to interpret locational premium or nuisance effect of certain locational factor, of which the coefficient directly shows the impact of the locational factor in comparing parcels within a 0.1km radius to parcels out of the buffer zones.

**Table 6-2: Property Values and Locational Factors: Summary Descriptives (2012)**

	Mean	St.D.	Min	Median	Max
EMV_LAND	289,376	269,136	67	206,828	1,230,158
EMV_BLDG	729,927	584,242	0	551,395	4,550,408
EMV_TOTAL	1,019,303	840,662	67	757,248	5,504,086
TAX_CAPACITY	9,258	7,278	1	6,903	53,066
PROP_TAX	14,038	11,254	1	10,383	97,354
Lake premium	0.38	0.39	0.00	0.33	1.00
Open-space Permium	0.35	0.42	0.00	0.00	1.00
Railroad Nuisance	0.03	0.12	0.00	0.00	1.00
Transit Premium	0.67	0.33	0.00	0.80	1.00
Highway Premium	0.11	0.21	0.00	0.00	1.00
Centroi- X	465772.93	2401.98	458972.40	466874.41	468399.93
Centroi- Y	4997987.22	874.47	4996755.62	4997854.37	4999979.03

Number of observations: 4844.

**Table 6-3: Property Values and Locational Factors: Estimated Results (2012)**

	EMV_LAND	EMV_BLDG	EMV_TOTAL	TAX_CAPACITY	PROP_TAX
(Intercept)	\$124,500,000 ***	\$584,700,000 ***	\$709,200,000 ***	\$5,713,000 ***	\$12,100,000 ***
Lake premium	\$92,850 ***	\$232,500 ***	\$325,400 ***	\$2,845 ***	\$3,762 ***
Open-space Permium	\$366,300 ***	\$775,800 ***	\$1,142,000 ***	\$9,203 ***	\$15,360 ***
Railroad Nuisance	-\$54,290 *	-\$95,270 *	-\$149,600 *	-\$872	\$2,169 *
Transit Premium	-\$220,700 ***	-\$555,900 ***	-\$776,600 ***	-\$6,168 ***	-\$9,177 ***
Highway Premium	\$45,080 **	\$20,370	\$65,450	\$1,612 ***	\$2,593 ***
Centroi- X	\$13 ***	\$40 ***	\$53 ***	\$0 ***	\$1 ***
Centroi- Y	-\$26 ***	-\$121 ***	-\$147 ***	-\$1 ***	-\$3 ***
<i>R-squared</i>	0.358	0.354	0.364	0.331	0.287

Signif. codes: 0 '\*\*\*' 0.001 '\*\*' 0.01 '\*' 0.05 '.' 0.1 ' ' 1; Degree of freedom: 4836

Using 2012 property assessment data, we modeled property values based on location factors. Summary Descriptives are shown in Table 6-2 and estimated results in Table 6-3. Five columns in the table correspond to five different models, each with a different dependent variable. The models fit well with most control variables showing significant effects in the predicted direction. The focus of this study, “Highway Premium,” shows positive effects on all five dependent variables, but with different magnitudes and levels of significance. Parcels within a 0.1 km radius of highway exits tend to have much higher assessed property values than parcels out of the buffer zones. The average difference in EMV of land is \$45,080 per acre, significant at the 0.01 level; the average difference in EMV of buildings is \$20,370 per acre, but it is not significant in common statistical levels. Consistent with value capture literature, this finding suggests that “Highway Premium” is accrued on the land much more so than on the buildings.

Higher property assessed values lead to higher property tax capacity and actual property tax revenues. According to Table 6-2, parcels with a 0.1 km radius of highway exits tend to have higher property tax capacity than parcels out of the buffer zones. The average difference is \$1,612 per acre. Parcels within a 0.1 km radius of highway exits also tend to have higher property tax contribution than parcels out of the buffer zones. The difference is \$3,762 per acre.

## Chapter 7. Projecting Property Value Changes after TH-610 Completion

It is assumed that within the study area that highway exits will increase from three to five after the TH-610 completion, with all other location factors remaining constant. Therefore, it is expected that parcels located near the two newly added exits will gain values with the Highway Premium. Figure 7-1 shows the five-layer buffers of highway exits after TH-610 completion. Applying model estimates in Table 6-2, changes of the EMV per acre around the two newly created exits were calculated and are illustrated in Figure 7-2.

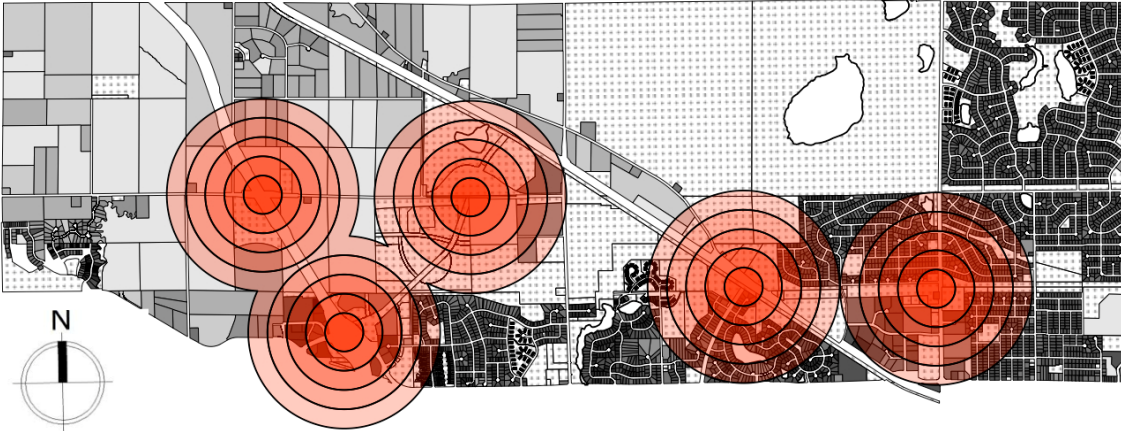

Figure 7-1: Five-layer Buffers of Highway Exits after TH-610 Completion

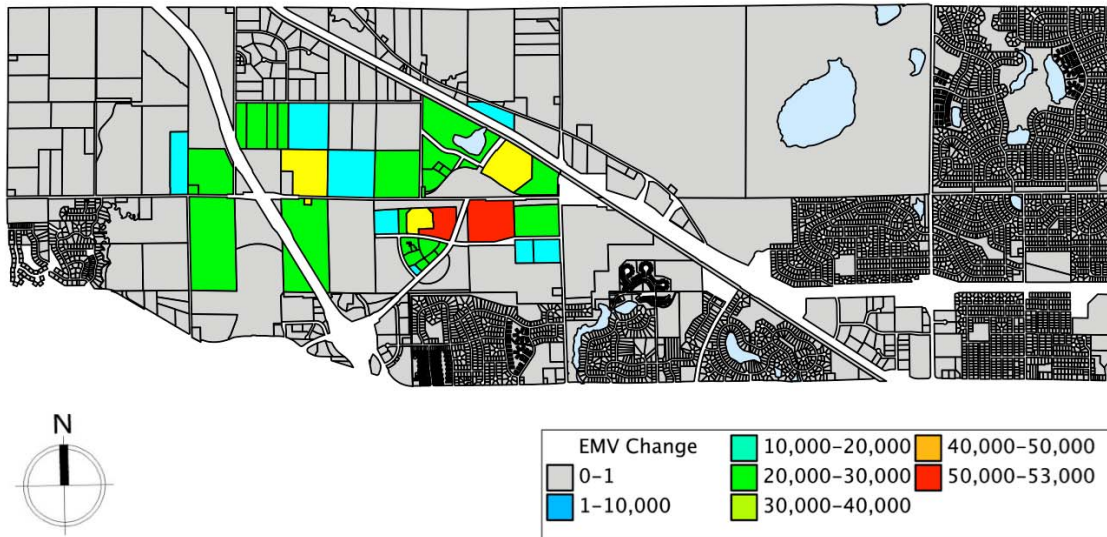

Figure 7-2: Projected EMV Increase after TH-610 Completion

Overall, with the completion of TH-610, it is expected that the enhanced accessibility due to two additional exits could lead to about \$11,928,000 in growth to the estimated market value for land (EMV\_LAND) and about \$5,390,000 in growth to the estimated market value for buildings (EMV\_BLDG). Adding the two together, there is about \$17,318,000 in growth to the total estimated property value (EMV\_TOTAL). The growth of the property values translate into about \$4,267,000 in property tax capacity and \$996,000 in property tax contribution.

## Chapter 8. Calculating Value Capture Potential

In this analysis, it is assumed that multiple value-capture schemes be applied within an Impact Zone, which is defined to include parcels that would see accessibility enhancement after the TH-610 completion. The accessibility enhancement is measured by a positive change in the variable of “Highway Premium.” For example, a parcel may be outside any multilayer buffer zone of existing highway exits, but will be within the 0.3–0.4 km zone for a new highway exit. The parcel’s “Highway Premium” were coded 0 originally but after the Th-610 completion were coded 0.4, with a positive change of “Highway Premium.” Figure 8-1 shows the Impact Zone which include 39 property parcels with a total area of 873 acres. Data about land use categories and property tax status are provided in Table 8-1. About 80% of the land use in the area within the Impact Zone is either farmlands or vacant lands which suggests a significant potential for future development. About 216 acres of the land’s tax status, roughly 25% of the Impact Zone, are currently exempt from property tax.

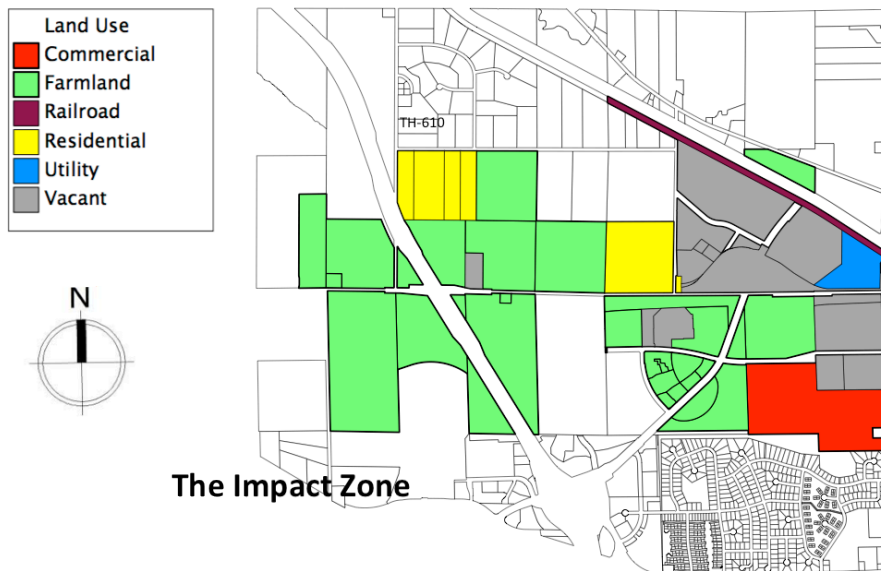

Figure 8-1: Land Use in the Impact Zone

**Table 8-1: Land Use and Tax Status within the Impact Zone**

	All Parcels		Taxable Parcels		Tax-exempt Parcels	
	Area	%	Area	%	Area	%
<b>Commercial</b>	71.1	8.1%	0.0	0.0%	71.1	32.9%
<b>Farm Land</b>	492.4	56.4%	388.3	59.1%	104.0	48.1%
<b>Industrial</b>	0.0	0.0%	0.0	0.0%	0.0	0.0%
<b>Public</b>	0.0	0.0%	0.0	0.0%	0.0	0.0%
<b>Lands</b>	0.0	0.0%	0.0	0.0%	0.0	0.0%
<b>Railroad</b>	13.6	1.6%	13.6	2.1%	0.0	0.0%
<b>Residential</b>	81.6	9.3%	81.6	12.4%	0.0	0.0%
<b>Utility</b>	17.1	2.0%	17.1	2.6%	0.0	0.0%
<b>Vacant Land</b>	197.2	22.6%	156.0	23.8%	41.2	19.0%
<b>Total</b>	872.8	100.0%	656.6	100.0%	216.3	100.0%

According to land use features within the Impact Zone, four scenarios of value capture are proposed. Estimated value capture amounts are reported below:

### **Scenario 1: Tax-Increment Financing**

Tax-Increment Financing could apply only to parcels within the Impact Zone that are subject to property taxes. The total area of these parcels is about 657 acre. The annual property tax increment would be about \$876,728. Assuming a 20-year Tax-Increment Financing, the total value of the tax increment would be about \$17,534,560.

### **Scenario 2: Special Assessments**

Unlike Tax-Increment Financing, Special Assessments could be applied to all parcels within the Impact Zone, regardless of whether they are tax exempt. Our analysis shows that within the Impact Zone, the average EMV growth would be about \$26,932 per acre. The total benefits for all parcels amount to about \$23,506,923. Assuming that we could capture 50% of the benefits through Special Assessments, the amount would be \$11,753,461.

### **Scenario 3: Special Assessments + Joint Development**

In the third scenario, we assume that parcels that are already developed and those that are tax-exempt would be subject to Special Assessments, while taxable parcels that are undeveloped would be subject to Joint Development. For about 328 acres of the developed parcels, Special Assessments at the 50% rate would have proceeds of about \$4,422,977. For about 544.4 acres of undeveloped parcels, assuming that the government could capture 75% of the EMV growth with land banking, the revenue would be about \$10,995,741. Adding the two streams, this scenario would lead to value capture revenue of about \$15,418,718.

### **Scenario 4: Special Assessments + Development Impact Fees**

In the final scenario, we assume that parcels that are already developed and those that are tax-exempt would be subject to Special Assessments, while taxable parcels that are undeveloped would be subject to Development Impact Fees. As we shown in Scenario 3, Special Assessments would lead to about \$4,422,977 revenue. For Development Impact Fees, we assume that the 544.4 acres of land could be developed into 1633 residential units (each with one third acre of land) after it's fully developed in the future. If we assume a \$20,000 Development Impact Fee on each newly developed residential unit, the total revenue of Development Impact



Fees would be about \$32,662,234. Thus this total value-capture scenario would lead to \$37,085,211.

To summarize, potential revenues based on different value-capture strategies are shown in Table 8-2:

**Table 8-2: Revenue Potential of Multiple Value Capture Scenarios**

<b>Value Capture Scenario</b>	<b>Revenue</b>
Tax-Increment Financing	\$17,534,560
Special Assessments	\$11,753,461
Special Assessments + Joint Development	\$15,418,718
Special Assessments + Development Impact Fees	\$37,085,211

## Chapter 9. Conclusion

Within the study area of Maple Grove, it is expected that the completion of TH-610, with enhanced accessibility from gaining additional highway exits, could significantly promote development activities nearby and contribute to Maple Grove's property tax base. This study is conducted to estimate the increase in value associated with the project's completion and assess the revenue potential associated with multiple value-capture schemes.

We defined a study area of about 10 square miles surrounding the unfinished TH-610 segment, and modeled property values based on five locational factors with parcel-level data from 2012. The estimated results provide significant evidence of a "Highway Premium." That is, parcels adjacent to highway exits tend to have much higher assessed property values than parcels farther away from highway exits, and the difference is more in land values than for buildings. For example, for parcels within a 0.1-km radius of highway exits, the premium on estimated market value (EMV) of land is \$45,080 per acre, while the premium on EMV of buildings is \$20,370 per acre.

Applying these model estimates, we expect that the completion of TH-610, with two additional exits, would lead to about \$11,928,000 in the growth of estimated market value for land (EMV\_LAND) and about \$5,390,000 in the growth of estimated market value for buildings (EMV\_BLDG) within the study area. Adding the two together, about \$17,318,000 would be the growth of total estimated property value (EMV\_TOTAL), resulting in about \$4,267,000 in property tax capacity, and about \$996,000 in property tax contribution. With multiple scenarios of hypothetical value-capture designs, we estimate the revenue potential of value capture to range from about \$12 million to about \$37 million that could be used to supplement project finance to expedite the completion of TH-610.

This research will have significant benefits for the TH-610 project and beyond. The primary end users of the research include MnDOT and its local partners in highway development, but the knowledge gained could benefit other states as well. If the value-capture schemes were implemented, they could generate additional funding to supplement the construction of TH-610, and accelerate the completion of the project. Even if the results were not used to help fund and accelerate TH-610 completion, the research demonstrates a way to estimate the value of transportation improvement and to communicate that to the public. Such research could greatly assist MnDOT, as well as local governments and other transportation stakeholders, to make informed decisions and to engage in joint efforts in transportation investment.

## References

- Altshuler, A.A., J. A. Gómez-Ibáñez, and A. M. Howitt (1993). *Regulation for revenue: The political economy of land use exactions*. Washington DC and Cambridge MA: Brookings Institution Press.
- Been, V. (2010). “Community benefits agreements: A new local government tool or another variation on the exactions theme?” *University of Chicago Law Review*, vol. 77, no. 1: 5–35.
- Writer (2010). “America’s fastest-growing cities 2010.” *Bloomberg Businessweek*. (Accessed October 2012),  
[http://images.businessweek.com/ss/10/01/0128\\_americas\\_fastest\\_growing\\_cities/24.htm](http://images.businessweek.com/ss/10/01/0128_americas_fastest_growing_cities/24.htm)
- HNTB Corporation (2011). Internet. *St. Croix River Crossing Project: Innovative Financing Study*. Minnesota Department of Transportation, (Accessed October 2012),  
[http://www.dot.state.mn.us/govrel/reports/2011/stillwater-if/St\\_Croix\\_Report\\_final.pdf](http://www.dot.state.mn.us/govrel/reports/2011/stillwater-if/St_Croix_Report_final.pdf).
- Iacono, M., A. Lari, D. Levinson and Z. Zhao, *Value Capture for Transportation Finance: Report to the Minnesota Legislature*, CTS 09-185. Center for Transportation Studies, University of Minnesota, Minneapolis, MN, 2009.
- Jung, C., C. Y. Roh, and Y. Kang (2009). “Longitudinal effects of impact fees and special assessments on the level of capital spending, taxes, and long-term debt in American cities.” *Public Finance Review*, vol. 37, no. 5: 613–636.
- King, D., K. J. Krizek and D. M. Levinson (2008). “Designing and assessing a teaching laboratory for an integrated land use and transportation course.” *Transportation Research Record*, vol. 2046, no. 1: 85–93.
- Mullen, C. (Internet), *National impact fee survey: 2008*, 2008. Duncan Associates, Austin, Texas. (Accessed October 2012),  
[http://www.impactfees.com/publications%20pdf/2008\\_survey.pdf](http://www.impactfees.com/publications%20pdf/2008_survey.pdf).
- National Surface Transportation Policy and Revenue Study Commission (2007). Internet. *Transportation for tomorrow: Report of the National Surface Transportation Policy and Revenue Study Commission*. (Accessed October 2012),  
[http://transportationfortomorrow.com/final\\_report/](http://transportationfortomorrow.com/final_report/).
- Zhao, Z. (2011). *Advancing public interest in public-private partnership of state highway development*. Center for Transportation Studies, University of Minnesota, Minneapolis. (Accessed October 2012),  
<http://www.cts.umn.edu/Publications/ResearchReports/reportdetail.html?id=2006>
- Zhao, Z. and K. V. Das (2010). “Tax increment financing as a value-capture strategy.” *Transportation Research Record*, vol. 2187: 1–7.

Zhao, Z., K. V. Das and C. Becker (2009). *Funding Surface Transportation in Minnesota: Past, Present, and Prospects, Research Report*, Center for Transportation Studies, University of Minnesota, Minneapolis, MN.

Zhao, Z., K. V. Das and K. Larson (2012). “Joint development as a value-capture strategy in public transit finance.” *Journal of Transport and Land Use*, vol. 5, no 1: 5–7.

Zhao, Z. and K. Larson (2011). “Special assessment financing as a value-capture strategy for public transit finance.” *Public Works Management and Policy*, vol. 16, no. 4: 320–40.

Zhao, Z. and D.M. Levinson (2012). “Introduction to the special issue on value capture for transportation finance.” *Journal of Transport and Land Use*, vol. 5, no. 1: 1–3.