



Minnesota
Department of
Transportation

**RESEARCH
SERVICES**

Office of
Policy Analysis,
Research &
Innovation

**Loop- and Length-Based Vehicle Classification,
Federal Highway Administration –
Pooled Fund Program
[TPF-5(192)]**

Erik Minge, Primary Author
SRF Consulting Group, Inc.
Minneapolis, Minnesota

November 2012

Research Project
Final Report 2012-33

Your Destination... Our Priority



To request this document in an alternative format, please contact the Affirmative Action Office at 651-366-4723 or 1-800-657-3774 (Greater Minnesota); 711 or 1-800-627-3529 (Minnesota Relay). You may also send an e-mail to ADArequest.dot@state.mn.us.

(Please request at least one week in advance).

Technical Report Documentation Page

1. Report No. MN/RC 2012-33	2.	3. Recipients Accession No.	
4. Title and Subtitle Loop- and Length-Based Vehicle Classification, Federal Highway Administration – Pooled Fund Program [TPF-5(192)]		5. Report Date November 2012	
		6.	
7. Author(s) Erik Minge, Scott Petersgn, Herbert Weinblatt, Benjamin Coifman, and Earl Hoekman		8. Performing Organization Report No.	
9. Performing Organization Name and Address SRF Consulting Group, Inc. One Carlson Parkway, Suite 150 Minneapolis, MN 55416		10. Project/Task/Work Unit No.	
		11. Contract (C) or Grant (G) No. (C) 95029	
12. Sponsoring Organization Name and Address Minnesota Department of Transportation Research Services 395 John Ireland Boulevard, MS 330 St. Paul, MN 55155		13. Type of Report and Period Covered Final Report	
		14. Sponsoring Agency Code	
15. Supplementary Notes http://www.lrrb.org/pdf/201233.pdf			
16. Abstract (Limit: 250 words) <p>While most vehicle classification currently conducted in the United States is axle-based, some applications could be supplemented or replaced by length-based data. Common length-based methods are more widespread and can be less expensive, including loop detectors and several types of non-loop sensors (both sidefire and in-road sensors). Loop detectors are the most frequently deployed detection system and most dual-loop installations have the capability of reporting vehicle lengths.</p> <p>This report analyzes various length-based vehicle classification schemes using geographically diverse data sets. This report also conducted field and laboratory tests of loop and non-loop sensors for their performance in determining vehicle length and vehicle speed.</p> <p>The study recommends a four bin length scheme with a fifth bin to be considered in areas with significant numbers of long combination vehicles. The field and laboratory testing found that across a variety of detection technologies, the sensors generally reported comparable length and speed data.</p>			
17. Document Analysis/Descriptors Vehicle classification scheme, Vehicle detection, Vehicle length, Speed detection, Loop detector, Non-intrusive technologies		18. Availability Statement No restrictions. Document available from: National Technical Information Services, Alexandria, Virginia 22312	
19. Security Class (this report) Unclassified	20. Security Class (this page) Unclassified	21. No. of Pages 106	22. Price

**Loop- and Length-Based Vehicle Classification,
Federal Highway Administration – Pooled Fund Program
[TPF-5(192)]**

Final Report

Prepared by:

Erik Minge
Scott Petersen
Herbert Weinblatt
Benjamin Coifman
Earl Hoekman

SRF Consulting Group, Inc.
Minneapolis, Minnesota

November 2012

Published by:

Minnesota Department of Transportation
Research Services
395 John Ireland Boulevard, MS 330
St. Paul, Minnesota 55155

This report represents the results of research conducted by the authors and does not necessarily represent the views or policies of the Minnesota Department of Transportation or SRF Consulting Group. This report does not contain a standard or specified technique.

The authors, the Minnesota Department of Transportation, and SRF Consulting Group do not endorse products or manufacturers. Any trade or manufacturers' names that may appear herein do so solely because they are considered essential to this report.

Acknowledgments

The project was guided by participating state agencies that are part of this pooled initiative. These individuals comprised the Technical Advisory Committee (TAC):

- Alaska Maryann Dierckman
- Colorado Aaron Moss
- Connecticut Anne-Marie McDonnell
- Florida Steven Bentz
- Idaho Jack Helton
- Illinois Rob Robinson
- Michigan Jim Kramer
- Minnesota Gene Hicks
- New York Kurt Matias
- Ohio Dave Gardner and Lindsey Pflum
- Pennsylvania Andrea Bahoric
- Texas Bill Knowles
- Washington Ken Lakey
- Wisconsin John Williamson
- Wyoming Sherman Wiseman

Table of Contents

Chapter 1: Project Overview	1
1.1 Introduction	1
1.2 Project Goals and Objectives	1
1.3 Project Team	2
1.3.1 <i>Project Audience</i>	2
Chapter 2: Literature Review	3
2.1 Vehicle and Loop Length	3
2.1.1 <i>Magnetic Length</i>	3
2.1.2 <i>Physical Length</i>	3
2.1.3 <i>Effective Loop Length</i>	3
2.2 Loop Characteristics	4
2.3 Loop Detector Operation Theory	7
2.4 Loop Detector Errors	9
2.4.1 <i>Documented Research of Detector Errors</i>	9
2.4.2 <i>Causes of Length-Based Error</i>	10
2.5 Length Classification Issues	12
2.6 Inductive Signature-Based Detectors	14
2.7 Non-Loop Detectors	16
2.8 Uses for Length-Based Classification Data	17
2.9 Literature Review Summary	18
Chapter 3: Length-Based Vehicle Classification Schemes	19
3.1 Development and Evaluation of LBVC Schemes	19
3.1.1 <i>Length-Based Classification Schemes</i>	19
3.1.2 <i>Data</i>	20
3.1.3 <i>Axle Classification</i>	22
3.1.4 <i>LBVC Scheme Evaluations Using LTPP Data from All Sites Combined</i>	23
3.1.5 <i>Locational and Temporal Influences</i>	31
3.1.6 <i>Urbanized Area Influence</i>	36
3.1.7 <i>Length Bins and Axle Classes</i>	37
3.1.8 <i>Estimation of Load Spectra Based on LBVC</i>	37

3.2	Length-Based Classification Scheme Recommendations	39
3.2.1	<i>Seasonal and Geographical Variation</i>	40
Chapter 4:	Detector Calibration Procedure	41
4.1	Recommended Calibration Process – Probe Vehicle Runs.....	41
4.2	Calibration Overview	42
4.3	Probe Vehicle Calibration Process.....	43
4.4	Probe Vehicle Validation Process	43
4.5	Alternative Calibration Methods.....	44
4.6	Rules of Thumb for Detector Calibration	47
Chapter 5:	Field and Laboratory Tests	48
5.1	Test Methodology	48
5.1.1	<i>Detectors Tested</i>	48
5.1.2	<i>Field Test Description</i>	49
5.1.3	<i>Laboratory Test Description</i>	49
5.1.4	<i>Baseline Description and Ground-Truthing</i>	50
5.1.5	<i>Loop Detector Installation</i>	52
5.1.6	<i>Non-Loop Detector Installation</i>	53
5.2	Field Test Results.....	55
5.2.1	<i>Length Accuracy</i>	55
5.2.2	<i>Loop Shape</i>	57
5.2.3	<i>Lead-In Distance</i>	60
5.2.4	<i>Speed Accuracy</i>	62
5.2.5	<i>False Detections and Missed Vehicles</i>	66
5.3	Laboratory Test Results	67
5.3.1	<i>Short Duration Tests – 35 Vehicle Test Cases</i>	68
5.3.2	<i>Long-Duration Test – Automobile and Semi-Truck at 40 and 70 MPH</i>	70
Chapter 6:	Conclusions	72
References	73
Appendix A: Loop Simulator Testing of Counter/Classifiers		
Appendix B: Minnesota DOT Loop Detector Standard Plates		

List of Figures

Figure 2.1: Distance vs. Signal Strength for a 6-foot x 6-foot Loop	5
Figure 2.2: Loop Length (<i>Lloop</i>) and Loop Spacing (<i>Dloopspacing</i>)	7
Figure 3.1: LBVC Schemes 1, 2 and 5	19
Figure 3.2: Vehicle Length by Axle Classification	21
Figure 4.1: Field Test, Distance Marking Stakes (40-foot spacing on both sides).....	45
Figure 5.1: Ground Truth Probe Vehicles.....	51
Figure 5.2: Ground Truth Probe Vehicles Scatter Plot.....	52
Figure 5.3: I-35 Test Site Loop Layout	54
Figure 5.4: Inductive Signature Detector Length Accuracy	57
Figure 5.5(a): Length Accuracy for 6'x6' vs. 6'x8' Loops	57
Figure 5.5(b): Length Accuracy for 6'x6' vs. 6'x8' Loops	57
Figure 5.5(c): Length Accuracy for 6'x6' vs. 6'x8' Loops	57
Figure 5.6: Blade Loop Sawcut Detail.....	60
Figure 5.7: Sample Long Lead-In Test Results	61
Figure 5.8(a): Loop Detector Speed Accuracy	62
Figure 5.8(b): Loop Detector Speed Accuracy	62
Figure 5.9: Non-Loop Detector Speed Accuracy	64
Figure 5.10: Length Distribution of Laboratory Test Vehicle.....	68
Figure 5.11: Short Duration Test – Avg. Absolute Speed Error by Classification Grouping	69
Figure 5.12: Short Duration Test – Per-Vehicle Average Absolute Error.....	69
Figure 5.13: Average Absolute Error – Clustered by Axle Classification Grouping	70
Figure 5.14: Average Absolute Error – Clustered by Vehicle Length Grouping	70
Figure 5.15: Long-Duration Test – Average Absolute Speed Error by Test Case	71
Figure 5.16: Long-Duration Test – Average Absolute Length Error by Test Case.....	71

List of Tables

Table 2.1: Inductance for Typical Loop	6
Table 2.2: Theoretical Errors per Measurement Due to Scan Rate	11
Table 2.3: Length-Based Classification Boundaries.....	12
Table 2.4: Misclassification Errors Due to Vehicle Length Classification	12
Table 3.1: Axle Classification Scheme	25
Table 3.2: Scheme 1 Results.....	27
Table 3.3: Scheme 5 Results.....	30
Table 3.4: Scheme 1 Length Boundaries for Individual LTPP Sites.....	32
Table 3.5(a)*: Scheme 1 Results for Kansas LTPP Site (Modified Boundaries).....	33
Table 3.5(b):** Scheme 1 Results for Kansas LTPP Site	34
Table 3.6: Scheme 1 M/L Length Boundaries for Individual Michigan Sites.....	36
Table 3.7: Scheme 1 Results for MnDOT TH 52 WIM Site	38
Table 5.1: Detectors Tested	48
Table 5.2: Video Method Ground Truth Results	51
Table 5.3: Loop Detector Length Accuracy – Normal Length (200’-300’) Lead-In.....	55
Table 5.4: Loop Detector Length Accuracy – Long (1,500 Feet) Lead-In.....	56
Table 5.5: Non-Loop Detector Length Accuracy	56
Table 5.6: Inductive-Signature-Based Loop Detector Length Accuracy.....	56
Table 5.7: Loop Detector Speed Absolute Average Error	62
Table 5.8: Non-Loop Detector – Absolute Average Speed Error.....	65
Table 5.9: Loop Detector Speed Bin Matrices.....	65
Table 5.10: Non-Loop Detector Speed Bin Matrices	66
Table 5.11: Loop Detector Count Errors	67
Table 5.12: Non-Loop Detector Count Errors	67

List of Acronyms

AAE	Average Absolute Error
AC	Axle Classification
ASTM	American Society for Testing and Materials
ATR	Automatic Traffic Recorder
DOT	Department of Transportation
FHWA	Federal Highway Administration
GTT	Global Traffic Technologies, Inc.
GVW	Gross Vehicle Weight
HPMS	Highway Performance Monitoring System
LBVC	Length-Based Vehicle Classification
LCV	Longer Combination Vehicles
LTPP	Long-Term Pavement Performance program
MnDOT	Minnesota Department of Transportation
nH	Nanohenry
PVR	Per-Vehicle Record
Q	Quality Factor
TAC	Technical Advisory Committee
TRAC	Washington State Transportation Center
VMT	Vehicle Miles Travelled
WIM	Weigh-in-Motion
μH	Microhenry

Length Classification Abbreviations

MC	Motorcycle
A	Automobile
S	Short
M	Medium
L	Long
VL	Very Long
T	Trailer

Executive Summary

Vehicle classification data is an important component of travel monitoring programs. While most vehicle classification currently conducted in the United States is axle-based, some applications could be supplemented or replaced by length-based data. One challenge with collecting axle-based data is the typically higher deployment cost and reliability issues as compared to length-based systems. Typical methods for collecting axle-based data are automatic piezoelectric sensor stations, weigh-in-motion (WIM) and manual methods. Conversely, common length-based methods are more widespread and can be less expensive, including loop detectors and several types of non-loop detectors. The most frequently deployed data collection method is loop detectors and most dual-loop installations have the capability of reporting vehicle lengths.

The Loop/Length-Based Vehicle Classification project is a transportation pooled fund study [TPF-5(192)] consisting of 15 state participants who provided guidance on the study's direction. The project is led by the Minnesota Department of Transportation (MnDOT). The project has: conducted an extensive literature search, developed length schemes and documented how they correlate to existing axle-based classification, recommended practical methods for calibrating loop and non-loop sensors, and conducted field and laboratory testing to explore sensor performance in the collection of speed and length data.

Length-Based Vehicle Classification Scheme

This study utilized existing data sources to develop a robust data set for analysis. The primary source of data was obtained from select Long Term Pavement Performance program (LTPP) WIM sites. In addition, data from several Michigan Department of Transportation WIM sites was used for supplementary analyses.

The figure on the next page presents the LTPP data sorted by axle-based classification to display the relative distribution of vehicle lengths for FHWA's 13 class scheme. Class 2, 3 and 5 vehicles with trailers were broken out and are considered separately. The black bars show the range of vehicle length per class. The histogram above each bar shows the relative distribution of vehicle lengths within that bin when separated into one-foot length bins. Each end of the bar and histogram were truncated at the point where the histogram was one standard deviation of the average length per class. This figure illustrates the overlapping nature of attempts to map axle-based classification to length bins.

Six length schemes were developed and tested using these data sets. The results were evaluated by comparing the schemes' length bin assignments to the axle class assignments produced by a modified version of the LTPP classification scheme.

The culmination of the data analysis is a set of scheme recommendations that provide meaningful guidance and are practical to implement. For most states, the recommended length-based vehicle classification (LBVC) scheme contains four bins (motorcycle, short, medium and long). These bins are designed so that the "short" bin produces counts that correspond to the number of autos and four-tire trucks without trailers, the "medium" bin produces counts that correspond to the number of other single-unit vehicles and number of vehicles with light trailers, and the "long" bin produces counts that correspond to the number of combination vehicles.

The length thresholds for these four length bins are listed here and shown on the figure below.

- Motorcycle: 0 to 6.5 feet
- Short vehicle: 6.5 to 21.5 feet
- Medium vehicle: 21.5 feet to 49 feet
- Long vehicle: 49 feet and larger

For states in which significant numbers of longer combination vehicles operate, a modified version of this scheme, using a fifth bin for very long vehicles, should be considered and the agency should select a length bin that captures long combination vehicles that operate within the state.

The data sets used to develop these four length bins were based on data samples from rural roadways. Follow-up data collection and analysis of an urbanized area found a lower use of trailers and a corresponding lower threshold between Medium and Long length bin of 43 feet. The urbanized area analysis also found the threshold between Short and Medium length vehicles to be 20 feet.

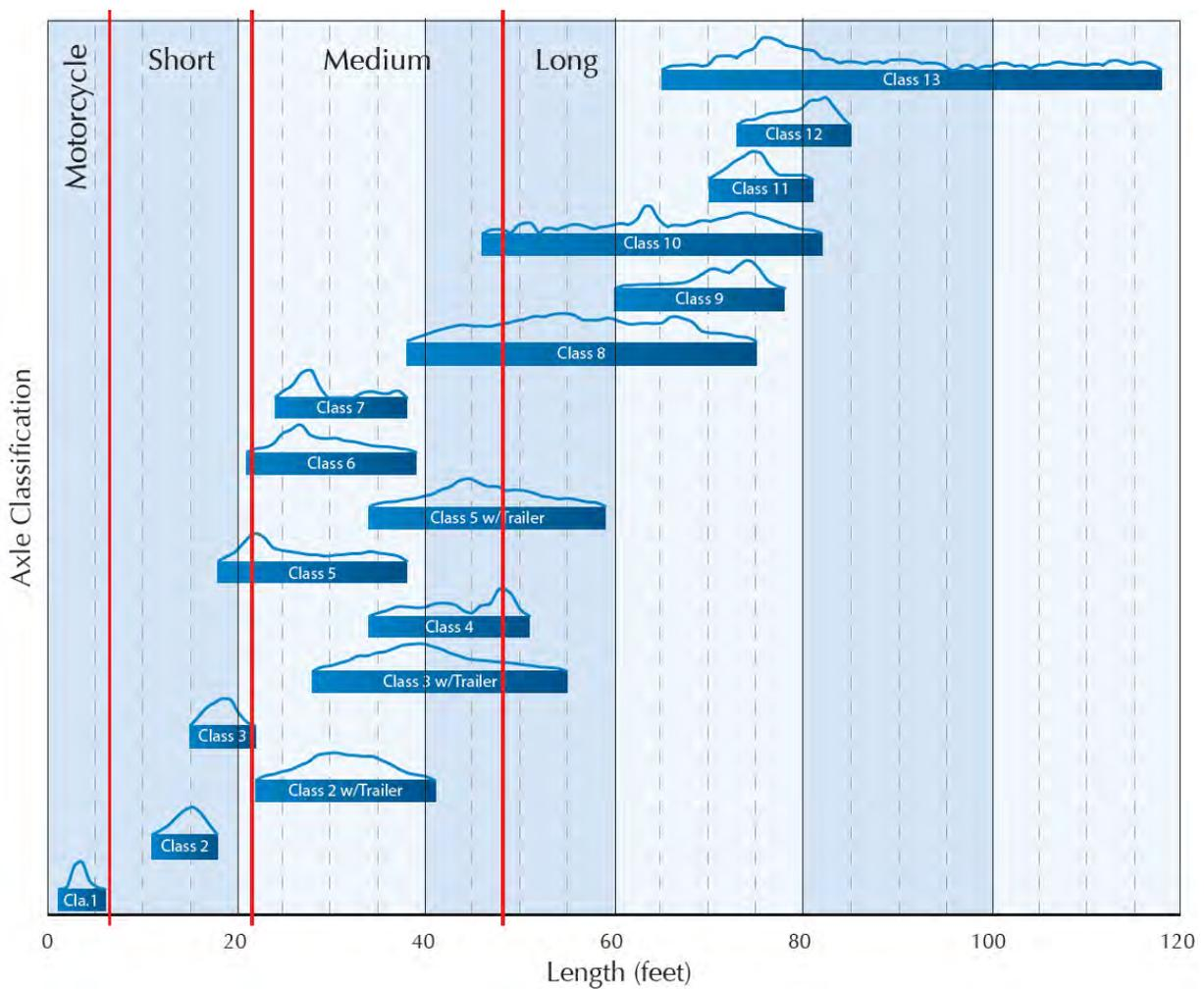

Vehicle Length by Axle Classification

In addition, if LBVC counts are to be collected during peak recreational season at sites where trailers are commonly operated (i.e. boat trailers), a third set of bin boundaries should be considered for these sites. Alternatively, LBVC counts on these roads should only be conducted during times of the year when minimal use is made of light trailers.

The testing performed in this study suggests that counts collected in rural areas using these bin boundaries usually provides estimates of the total number axle-classified vehicles to the corresponding length bins within three percent.

LBVC Detector/Classifier Testing

Field and laboratory testing was conducted to determine the accuracy of commercially available vehicle length detectors.

Field Test Methodology

The field tests quantified detector length and speed error. The following detectors were tested.

Loop Detectors

Manufacturer	Model
Diamond	Phoenix I
Diamond	Phoenix II
GTT	Canoga C944
IRD	TCC-540
IRD	TRS
PEEK	ADR 3000

Non-Loop Detectors

Manufacturer	Model
GTT	Canoga Microloops (C944 Card)
Vaisala/Nu-Metrics	Hi-Star NC200 ION
Vaisala/Nu-Metrics	Hi-Star NC300
Wavetronix	SmartSensor HD

Inductive Signature Detectors

Manufacturer	Model
Diamond	iLoop
IST	IST-222
PEEK	ADR 6000

The three inductive signature-based loop detectors use alternative means to perform length measurement: the PEEK ADR 6000 detects axles to do axle-based classification, and the Inductive Signature Technologies (IST) and Diamond iLoop products use an inductive vehicle signature match to known inductive signatures. Because these capabilities are not directly comparable to the length classification, these methods were independently evaluated.

Detector length accuracy was determined by comparing per vehicle records from each of the detectors to the high-definition video baseline. Loop detectors were connected to the ten loops at the I-35 test site in the city of Wyoming, Minnesota. The video-measured length was compared

to the “magnetic length” that the detector reported on a per-vehicle basis. The speed data was compared to either piezoelectric sensor data or a correspondence algorithm that averaged detected speeds from multiple detectors within a preset tolerance. Data was collected as traffic travelled at free-flow speeds.

In order to minimize the effect of balancing errors (positive and negative errors balancing each other), the absolute value of each per vehicle record was determined. The numbers presented generally show the average absolute error.

Laboratory Test Methodology

In order to compare technical aspects of the loop detectors, a series of laboratory tests were conducted using a loop simulator. This allowed for the direct comparison of the same inductance waveforms “played back” on each of the loop detectors. The inductance waveforms were collected by recording vehicles travelling at freeway speeds over loops at the I-35 test site. These vehicles were video recorded to determine their lengths and speeds. Where possible, exact vehicle models were identified and manufacturer-published physical lengths were used for baseline lengths.

Length Accuracy Results

The field and laboratory testing found that despite different specifications, such as inductance, sensitivity and scan rate, the detectors generally reported comparable length data.

The 6’x6’ loops performed similarly to 6’x8’ loops. The 6’x6’ quadrupole loops performed poorly for vehicles with high beds due to the quadrupole loop’s relatively small magnetic field. Laboratory testing found generally small absolute errors, revealing that loop detector data is generally repeatable.

The average absolute length error for 6’x6’ loops with short lead-ins ranged from 1.24 to 1.98 feet across all vehicles. The GTT Canoga card had the highest average absolute error, but this detector only reports data to the full foot (not tenths of a foot like most other detectors), so includes additional error. The table below summarizes the test findings for loop-based detectors.

Loop Detector Length Accuracy – Normal Length Lead-In Average Absolute Error

Manufacturer	Model	6’x6’ loops (feet)	6’x8’ loops (feet)	Quadrupoles (feet)
Diamond	Phoenix I	1.24	1.79	3.5
Diamond	Phoenix II	1.74	1.09	4.0
GTT	Canoga C944	1.98	1.85	3.4
IRD	TCC-540	1.31	1.42	3.9
IRD	TRS	1.64	1.44	Did Not Function
PEEK	ADR 3000	1.34	2.05	3.8

Based on these findings, this project finds validity in the current practice of installing 6’x6’ square loops. As an alternative, 6’x8’ loops are also acceptable, and may offer improved performance in motorcycle detection. As with most field installation practices, a quality installation is important for obtaining good data.

Loop detector lead-in length was evaluated by comparing per-vehicle reported vehicle lengths from loop pairs with a long lead-in (1,500 feet) to a loop pair with a short lead-in (300 feet). It was found that when controlling for other factors, long lead ins do not have a significant effect on length detection performance.

The following table summarizes the findings for the four non-loop sensors that were evaluated.

Non-Loop Detector Length Average Absolute Error

Manufacturer	Model	Average Absolute Length Error (feet)
GTT	Canoga Microloops with C944 Card	5.81
Vaisala/Nu-Metrics	Hi-Star NC200 ION	2.65
Vaisala/Nu-Metrics	Hi-Star NC300	3.87
Wavetronix	SmartSensor HD	2.49

Inductive signature-based loop detectors were also tested for their length measurement performance. The following table shows the length accuracy for the signature-based detectors.

Inductive Signature Detector Length Average Absolute Error

Manufacturer/Model	Loop Configuration Tested	Average Absolute Error (feet)
Diamond iLoop	6'x6' Loops	1.61
IST IST-222	6'x6' Loops	1.32
PEEK ADR 6000	6'x6'/Quadrupole Combination	1.36

Each of the inductive signature-based detectors specializes in a particular function that is not necessarily related to length detection performance. In particular, the Diamond iLoop is designed to be able to identify vehicles' inductive signatures and then match the signature with known vehicle lengths. The PEEK ADR 6000 is designed to detect axle spacings and report axle-based classification. However, these detectors also feature more sophisticated electronics that offer higher scan rates that may offer higher resolution data.

Speed Accuracy Results

As with the length accuracy analysis, the primary method for analyzing speed data was to compare per vehicle speed records against a baseline. Field testing results of the average absolute speed error for conventional loop detectors is provided in the following table.

Loop Detector Speed Average Absolute Error

Model	Average Absolute Error (mph)
Diamond Phoenix I	1.67
Diamond Phoenix II	1.74
GTT Canoga C944	2.14
IRD TCC-540	1.81
IRD TRS	1.82
PEEK ADR 3000	5.33

The laboratory testing showed that when the vehicles are clustered by axle class, all of the classifiers except TRS exhibited the worst performance on motorcycles. The class that provided the most accurate speeds was passenger vehicles, followed by single unit trucks and then multi-unit trucks.

Detector Calibration and Validation

This study also prepared recommendations for calibrating and validating existing loop-based detector station. Based on experience gained in the field, the recommended calibration procedure is to use a probe vehicle whose length has been accurately measured. This vehicle should be driven repeatedly through the detection area to serve as a baseline for iterative calibration. Once the detector has been calibrated and is reporting vehicle length within one mile per hour for speed and one foot for length, validation runs may be performed. After obtaining a series of subsequent runs that result in repeatable accurate data, the calibration may be accepted.

Conclusion

The report presents the literature review, analysis, field and laboratory test results conducted to develop these findings. Length-based detection has become common and this research provides information for the establishment of length bins and accuracy standards for the calibration and testing of detection sites.

Chapter 1: Project Overview

1.1 Introduction

The Minnesota Department of Transportation (MnDOT), with funding assistance and technical guidance from the 15 pooled fund project members, conducted a study of length-based vehicle classification (LBVC) [TPF-5(192)]. The Federal Highway Administration (FHWA) contributed technical assistance. The project has dual focuses of both using analysis methods to recommend standardized length classes, and conducting field and laboratory tests of loop and non-loop detectors.

While most vehicle classification currently conducted in the United States is axle-based, some applications could be supplemented or replaced by length-based data. One challenge with collecting axle-based data is the typically higher deployment cost and reliability issues as compared to length-based systems. Typical methods for collecting axle-based data are automatic piezoelectric (piezo) sensor stations, weigh-in-motion (WIM) and manual methods. Conversely, common length-based methods are more widespread and can be less expensive, including loop detectors and several types of non-loop detectors (both sidefire and in-road sensors). The most frequently deployed data collection method is loop detectors and most dual-loop installations have the capability of reporting vehicle lengths.

This project developed schemes for length-based classification to augment or replace some of the axle-based data collection. However, some classification precision is lost if only length-based data is collected, so the limitations of this data must be understood.

1.2 Project Goals and Objectives

A series of goals and objectives were developed to guide the project activities.

Goal 1: Document best practices for sensor installation and calibration methods.

- Objective 1-1. Develop recommended loop installation practices.
- Objective 1-2. Develop general and sensor-specific loop calibration procedures.
- Objective 1-3. Document non-loop installation and calibration practices.

Goal 2: Test LBVC methods.

- Objective 2-1. Conduct laboratory tests of six loop LBVC detection systems
- Objective 2-2. Conduct field tests of six loop LBVC detection systems.
- Objective 2-3. Conduct field tests of four non-loop LBVC detection systems.
- Objective 2-4. Define general and sensor-specific performance expectations and limitations.

Goal 3: Develop LBVC classification schemes.

- Objective 3-1. Evaluate regional and functional differences related to LBVC data.
- Objective 3-2. Develop multiple classification schemes that reflect variations in LBVC data.

- Objective 3-3. Relate LBVC data to axle-based vehicle classification data.
- Objective 3-4. Evaluate performance of proposed LBVC classification schemes against axle-based classification schemes.

1.3 Project Team

The project was managed and conducted by a core group of project team members:

- Gene Hicks, MnDOT – MnDOT Project Manager
- Steven Jessberger, FHWA – Project Liaison
- Erik Minge, SRF Consulting Group, Inc. – SRF Project Manager
- Scott Petersen, SRF Consulting Group, Inc. – Project Team Member
- Herb Weinblatt, Cambridge Systematics – Project Team Member
- Earl Hoekman, EL Enterprises – Project Team Member
- Ben Coifman – Project Team Member

1.3.1 Project Audience

This project should produce a valuable reference for future research and practical use to transportation professionals. This research is primarily conducted for the travel monitoring community, but other researchers and practitioners can benefit as this area has not been thoroughly analyzed. The following entities can benefit from the research done in this project.

- Data collection practitioners
- Traffic operations practitioners
- Professional organizations
- Transportation agencies
- Transportation researchers
- Traffic detector vendors

Chapter 2: Literature Review

A review of the literature on length-based classification, loop detectors and non-loop detectors and in general revealed the following topics. These topics are explored in more detail in the sections that follow.

- Vehicle and Loop Length
- Loop Characteristics
- Loop Detector Errors
- Length Classification Issues
- Inductive Signature-Based Detectors
- Non-Loop Detectors
- Uses for Length-Based Classification

2.1 Vehicle and Loop Length

Before describing technical issues related to loop detectors and length-based classification, various definitions of length are presented.

2.1.1 Magnetic Length

The “magnetic length” of the vehicle is the length detected by a loop detector. The loop cannot detect non-metallic materials on the vehicle such as plastic bumpers. Also, the vertical position of the metal in the vehicle is important. Because the magnetic field radiates from the loop turns in a generally circular pattern, as a vehicle passes over a loop, metal that is higher up (further from the loop turn) would likely be detected later (and dropped earlier) than metal that is closer to the ground. For example, the length of a high bed truck may be measured smaller due to this effect.

2.1.2 Physical Length

The “physical length” of a vehicle is also known as the bumper-to-bumper length. Probe vehicle lengths were measured by holding a plumb bob from each end of the bumper (at the widest point) and measuring the distance between them with a measuring tape on the ground.

2.1.3 Effective Loop Length

Effective loop length is a term some detector manufacturers use to describe the size of the loop. Since a loop detector measures changes in inductance as objects travel through its magnetic field, the physical size of the magnetic field must be distinguished from the physical size of the loop. When a vehicle passes over a loop detector, most detectors use the total time the vehicle occupies either loop and subtracts an amount of time that the vehicle is over both loops to determine vehicle length. This time is directly related to the “effective loop length.” In practice, it is common to use the physical loop size as the first iteration for calibration of effective loop length.

2.2 Loop Characteristics

Little of the existing literature addresses the specific loop characteristics that contribute to loop detector performance. Part of the reason for this may be that, in practice, most loop detectors function relatively well across a wide range of loop parameters, especially for traffic volume (and speed for dual loop sites).

Of the states surveyed in this project, most use relatively consistent methods for installing and configuring loop detectors. These “standard” parameters include:

- 6-foot x 6-foot square loops
- 4 wire turns per loop
- Shallow depth (3 inches to 4 inches)
- Twisted pair homerun cable of 200 feet or less (some use shielded cable)

The remainder of this section explores the factors that affect performance for each of these parameters.

Loop Shape. The most commonly installed loop shape is a 6-foot x 6-foot square laid with two sides parallel and two sides perpendicular to the direction of travel. In many cases, the “square” loops are actually octagonal loops. In order to reduce strain on the loop wires at the corners, 45-degree cuts are commonly made in the corners of the square. In practice, these loops are still called 6-foot x 6-foot square loops. Octagonal loops that attempt to mimic round loop are also sometimes used, although not by any of the states that responded to the survey done for this project.

Other configurations are sometimes used to meet alternate criteria. California and Oregon, among others, use round loops. The primary advantages of round loops are that the loop sawcutting can be done quickly with specialized equipment and that pavement damage due to saw overcuts at the corners is eliminated. In essence, a large machine with a circular blade cuts the circular sawcut in seconds rather than a series of straight, precise sawcuts. A straight saw is still required for the lead-in cables. A disadvantage to using round loops is that speed errors are larger in comparison to square loops because the vehicle detection point relative to the loop varies more with respect to vehicle position in the lane. This phenomenon would also be apparent with other loop shapes that do not have a leading edge that is perpendicular to the direction of traffic.

Another configuration that holds some merit is a diamond shape. The advantage of using a diamond shape is that the detector is sometimes able to hold a call as a hitch passes over the loop. Another advantage is that this configuration reduces cross talk amongst loops because there is only a small vertex at the edge of the lane compared to a whole line segment at the edge of a square loop.

Loop Depth. A relatively shallow loop depth is used by the departments of transportation (DOT) surveyed. The advantage of a shallow loop depth is that the loop is close to the underside of the vehicles passing over it. The height of detection is approximately one-half to two thirds of the

loop width¹. The disadvantage of shallow loops is that they are more likely to be damaged, especially in milling and overlay operations. Some agencies bury loops deep (even under the pavement) to avoid issues with loops being damaged. The paving material between the loop and vehicles has little effect on the ability of the loop detection system to detect vehicles accurately. As noted in the Traffic Detector Handbook, the minimum sawcut depth recommended for a three-turn loop is 1-9/16 inches. Each turn requires about 1/4-inch of depth. Thus, in a 3-inch sawcut, the loop wires are contained in the bottom 3/4-inch of the sawcut. If the top two inches of pavement were milled from the pavement, the loops might not be damaged. However, sometimes the milling machine breaks the pavement to sealant bond and lifts the wires up and cuts them off.

The change in inductance caused by a vehicle decreases rapidly as the distance from the loop to the vehicle increases. As the basic distance of the vehicle from the loop increases, the number of turns the loop has should increase. It is also desirable to increase the number of turns when reinforcing steel is near the loop. Figure 2.2 shows the relationship between distance and signal strength.

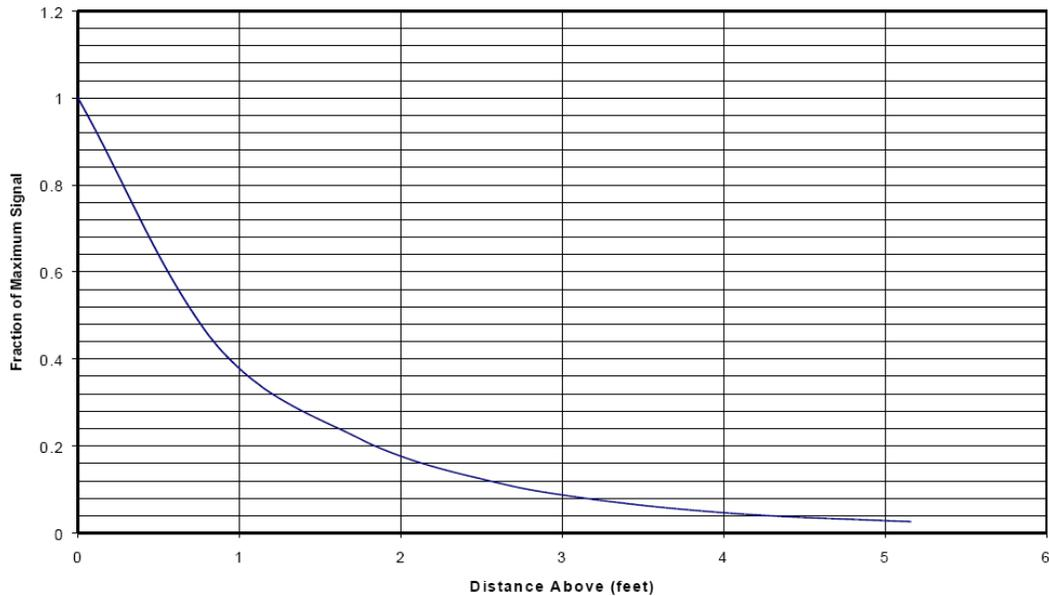

Figure 2.1: Distance vs. Signal Strength for a 6-foot x 6-foot Loop

Number of Turns. The number of wire turns in a loop has a significant effect on the inductance of the loop. While most loop detectors have a wide range of acceptable loop inductances, two to four turns fit in the generally accepted range of optimal inductance. Only special situations require more or fewer turns to meet specific criteria. For example, some loops with long lead-ins require additional turns. Table 2.1 shows a sample of the relationship between inductance and the

¹ Ibid.

number of turns for a 6-foot x 6-foot loop at 20 kHz². As shown in Table 2.1, the inductance increases exponentially with a higher number of turns.

Table 2.1: Inductance for Typical Loop

Number of Turns	1	2	3	4	5
Inductance (μH)*	63	89	128	180	243

**6-foot x 6-foot loop with 250 feet of lead-in cable running at 20 kHz*

Source: Klein et al., 2006

The number of turns is the primary determinant of the vehicle detection signal-to-noise ratio. Sometimes more turns are required to achieve high accuracy rates as an installation strays from the ideal configuration.

Reinforcing Steel in Pavement. Although loops are often installed in concrete, it is recommended to avoid installing loops in pavements with reinforcing steel. One issue that was raised in the June 2010 TAC meeting was that reinforcing steel in concrete can delay a loop call or can hold a call after the vehicle passes over the loop, although research that substantiates this claim could not be found. It was said that steel could act as a loop and interfering with the inductive loop with crosstalk. Some agencies specifically avoid installing loops under reinforcing steel, but it is also suggested to not install loops over reinforcing steel for concerns like this. The testing was originally planned to be done near MnDOT’s MnROAD facility. However, the subject pavement section was found to have wire mesh reinforcement which significantly degrades the performance of loop detectors.

Lead-In Length. The lead-in length is important for detectors with sensitivity set as a percentage of total loop inductance (the most common approach) such as 0.05 percent. Lead-in length is not important when sensitivity is set as an absolute value change in inductance such as 128 nanohenries (nH). Sensitivity is the signal level, compared to the level when no vehicle is influencing the sensor, at which a vehicle is said to be present. Percentage Sensitivity is when that level is defined as a sensor inductance decrease that is a specific percentage of the total sensor inductance.

The effect of a vehicle on a loop does not change as the lead-in length increases. However, the total effective sensor inductance increases approximately 20 microhenries (μH) per 100 feet of cable. A 4-turn 6-foot x 6-foot loop has an inductance of about 128 μH. Adding 200 feet of cable raises the effective inductance of the loop to about 168 μH. Adding 1,500 feet of cable raises the effective inductance of the loop to about 428 μH. A detector set to detect at a 0.1 percent change with a 128 μH sensor detects a change of 128 nH. A detector set to detect a 0.1 percent change with a 168 μH sensor detects a change of 168 nH. The extra lead-in cable reduced the sensitivity such that to be detected a vehicle must change the loop inductance about 1.3 times more than when the 200 feet of lead-in was not in place. Thus, changing lead-in cable length impacts

² Ibid.

detection thresholds and occupancy measurements for detectors having the detection threshold set as a percentage of the sensor inductance.

Wire Gauge of Loop Wire and Lead-In Cable. The gauge of the loop wire and gauge of the lead-in/home run cable do not significantly impact detection performance. Reduction of the gauge has slightly more impact on detectors designed to detect changes in the Quality Factor (Q) as well as changes in inductance. Quality Factor is a measure of the energy lost during each oscillation of the sensor drive signal. The higher the Q, (loops are usually greater than five) the lower the energy losses each cycle.

The gauge and stranding of wire used for forming loops does impact loop durability. Flexibility and elasticity with stranded wire is desirable. Wire insulation type also impacts loop durability.

In summary, there are several factors that have related effects on loop performance. The review confirms that the standard methods for installing loops are acceptable and recommended for evaluation. The review indicates that the configurations recommended by the TAC are the optimal conditions for most parameters.

2.3 Loop Detector Operation Theory

Loop-based detectors generally use the following equation to derive vehicle length.

$$L_{vehicle} = V_{vehicle} * T_{detect} - L_{loop}$$

$L_{vehicle}$ is the length of the vehicle

$V_{vehicle}$ is vehicle speed

T_{detect} is the time duration a vehicle occupies a single loop

L_{loop} is the loop length

Note that this formula requires the vehicle speed to be known. Loop detectors generally detect vehicle speed by comparing the times of detection events of a pair of loops arranged in series. Figure 4.1 illustrates a typical “speed trap” setup and shows the loop length and loop spacing parameters that calibration generally aims to adjust.

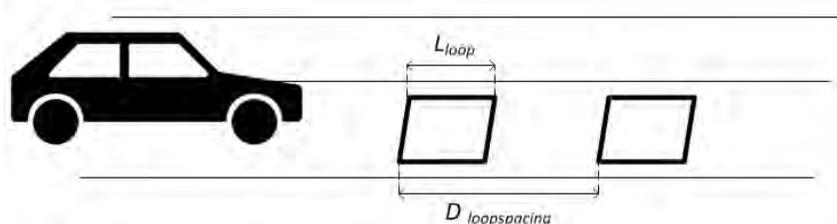

Figure 2.2: Loop Length (L_{loop}) and Loop Spacing ($D_{loopspaceing}$)

The following formula generally governs the vehicle speed calculation.

$$V_{vehicle} = \frac{D_{loopspacing}}{t_{vehdetlagloop} - t_{vehdetleadloop}}$$

$V_{vehicle}$ is the vehicle speed

$D_{loopspacing}$ is the distance from the leading edge of the lead loop to leading edge of the lag loop

$t_{vehdetleadloop}$ is the time of vehicle detection at the lead loop

$t_{vehdetlagloop}$ is the time of vehicle detection at the lag loop

Theoretically, a detector could be calibrated using a vehicle of known length traveling at a known speed in a single pass. The equations presented here govern the factors that could be calibrated. However, calibration is an iterative process and multiple runs are necessary to confirm that proper calibration was achieved.

In these equations, the calibration factors are called D_{cal} and L_{cal} which respectively represent the calibrated loop spacing and the calibrated loop length.

$$D_{cal} = D_{initial} * \frac{V_{actual}}{V_{meas}}$$

$$L_{cal} = T_{detect} * V_{actual} - L_{veh actual} = \frac{L_{veh meas} + L_{initial}}{V_{meas}} * V_{actual} - L_{veh actual}$$

D_{cal} is the calibrated loop spacing (loop spacing that will give the correct vehicle speed)

$D_{initial}$ is the assumed initial loop spacing (loop spacing used during calibration run)

V_{actual} is the vehicle speed during calibration run

V_{meas} is the vehicle speed as measured by the device during the calibration run

$L_{initial}$ is the assumed initial loop length (loop length used during calibration run)

L_{cal} is the loop length that will result in the correct vehicle length measurement

$L_{veh actual}$ is the actual bumper-to-bumper vehicle length

$L_{veh meas}$ is the vehicle length as measured by the device during the calibration run (magnetic length)

T_{detect} is the duration of vehicle detection during calibration run (generally not directly reported by the measurement device).

Note: For practical purposes, vehicle speeds used for calibration should be converted to consistent units (for example, feet per second) to ease analysis. 1 mph = 1.4667 ft/s.

2.4 Loop Detector Errors

2.4.1 Documented Research of Detector Errors

Conventional loop detector stations measure individual vehicle actuations and then aggregate these data to flow, occupancy and average speed over fixed time periods, typically ranging from 20 seconds to 5 minutes. The individual actuations are then typically discarded. Several researchers have developed statistical tests to evaluate whether the time series aggregate data are within statistical tolerance³. Because these automated systems only use aggregated data, they must accept a large sample variance and potentially miss problems altogether. For example, the systems have to tolerate a variable percentage of long vehicles in the sample population. As the percentage of long vehicles increases, the occupancy/flow ratio should increase simply because a long vehicle occupies the detector for more time compared to a shorter vehicle traveling at the same velocity⁴.

Chen and May⁵ developed a new approach for verifying detector data using event data that employs individual vehicle actuations. Their methodology examines the distribution of vehicles' over time. Unlike conventional aggregate measures, their approach is sensitive to errors such as "pulse breakups", where a single vehicle registers multiple actuations because the sensor output flickers off and back on, i.e., dropping out. Coifman⁶ went a step further and compared the measured on-times from each loop in a dual loop detector on a vehicle-by-vehicle basis. At free flow velocities the on-times from the two loops should be virtually identical regardless of vehicle length, even allowing for hard decelerations. Many hardware and software impreciseness will cause the two on-times to differ. At lower velocities, vehicle acceleration can cause the two on-times to differ even though both loops are functioning properly; and thus, congested periods were excluded from the earlier analysis. Coifman and Dhoorjaty⁷ developed a suite of event data based tests to catch several detector errors based on physical constraints (feasible vehicle length, feasible headways, etc.). Zhan et al.⁸, and Cheevarunothai et al.⁹, continued the research, setting

³ Jacobson, L, Nihan, N., & Bender, J. (1990). Detecting erroneous loop detector data in a freeway traffic management system. *Transportation Research Record*, 1287, 151–166.

Cleghorn, D., Hall, F., & Garbuio, D. (1991). Improved data screening techniques for freeway traffic management systems. *Transportation Research Record*, 1320, 17–31.

Nihan, N. (1997). Aid to determining freeway metering rates and detecting loop errors. *Journal of Transportation Engineering*. 123(6), 454–458.

⁴ Coifman, B. (2001). Improved velocity estimation using single loop detectors. *Transportation Research: Part A*, 35(10), 863–880.

⁵ Chen, L., & May, A. (1987). Traffic detector errors and diagnostics. *Transportation Research Record*, 1132, 82–93.

⁶ Coifman, B. (1999). Using dual loop speed traps to identify detector errors. *Transportation Research Record*, 1683, 47–58.

⁷ Coifman, B., & Dhoorjaty, S. (2004). Event data based traffic detector validation tests. *Journal of Transportation Engineering*, 130(3), 313–321.

⁸ Zhang, X., Nihan, N., & Wang, Y. (2005). Improved dual-loop detection system for collecting real-time truck data. *Transportation Research Record*, 1917, 108–115.

out the specific objective of "identifying possible causes of dual-loop errors and developing a new dual-loop algorithm that could tolerate erroneous loop actuation signals."

Improper or inadequate system setup is another prominent cause of error. However, users frequently don't notice these errors because the errors are not gross enough to be dramatically obvious.

2.4.2 Causes of Length-Based Error

Speed Measurement Error. The literature search found that there are three interrelated parameters that can be measured or estimated for each passing vehicle, namely length (l), speed (v) and the amount of time the detector is "on", i.e., the on-time (on). These parameters are related by the following equation,

$$l = v \cdot on \quad \text{- effective sensor detection length}$$

The distinction between different detection technologies is important. Conventional dual-loop detectors can measure both on-time and speed directly, and so they are often employed to classify vehicles based on length. Conventional single-loop detectors can only measure on-time. In the absence of accurate speed estimation from single-loops, these detectors have not been used to estimate vehicle length or classify vehicles.

Detector Scan Time and Vehicle Speed. The resolution with which the detector samples the inductance can be a major factor for accurately measuring vehicles. The precision of the measurement is only +/- 1 scan time unit. Higher scan rates (cycles per second) will reduce this error. This error is typically random and Table 2 shows the range of calculated error for a few sample scan rates with sample speeds. It is important to note that the time is recorded four times in a dual loop configuration (Loop A "on" and "off" and Loop B "on" and "off"). Assume a simple case for calculation of the length where the occupied time of the first loop and the difference between "on" times of the loops is used. The errors could potentially be four times as great if the Loop A "on" is detected one scan time increment too early, the Loop A "off" is detected late and the Loop B "on" is detected late. While it is unlikely that a vehicle would be recorded all four times at the precise moment to maximize error, there is a range of error from zero to two times the calculated length error (one per pair of measurements). Thus, for a theoretical detector with a 200 Hz scan rate, a vehicle travelling 60 mph could have an error of up to two feet only based on a lack of precise scan times. Thus a perfectly operating system with a relatively fast 200 Hz scan rate has a vehicle length measurement error of $\pm 13.3\%$ for autos (percent error is higher for motorcycles and may be less for very long trucks). Very fast scan rates, such as 1,000 Hz, produce far less, such as 0.42-foot maximum error for a vehicle travelling 60 mph.

⁹ Cheevarunothai, P., Wang, Y., & Nihan N., (2007). Using dual-loop event data to enhance truck data accuracy. *Proceedings of the Transportation Research Board Annual Meeting*.

Table 2.2: Theoretical Errors per Measurement Due to Scan Rate

Speed	Maximum Theoretical Error Per Measurement (ft)		
	200 Hz	400 Hz	1,000 Hz
10 mph	0.354	0.178	0.071
30 mph	1.04	0.539	0.213
60 mph	2.03	1.04	0.424

Vehicle Height Above Sensor. Loops with detectors set to correctly measure the length of autos will measure vehicles higher above the pavement as shorter than they actually are, e.g., trucks are measured at least 3 feet (frequently 6 feet) shorter than they actually are.

Effective Sensor Length. Improper setting of detector sensitivity will affect the accuracy of speed measurement and the accuracy of measuring time over sensor.

For accurate speed measurements, the effective distance between loops must be equal to the distance between loops that the system is using to calculate speed. The distance used to calculate speed is usually the physical distance between loops. For the effective loop spacing to equal the physical loop spacing, a vehicle must be detected at the same point relative to the loop at the lead loop and at the lag loop. One might assume that setting the sensitivity the same on the lead channel and the lag channel would accomplish this. Unfortunately, this is frequently not true. The effect a vehicle has on a loop, as seen by the vehicle detector, is very dependent whether the loop has reinforcing bar beneath it, the depth of the loop from the pavement surface, the number of turns in the loop and, for detectors having detection thresholds specified in percent, on the length of the cable between the loop and the vehicle detector. For accurate speed measurement, the sensitivity for each loop should be set at about 1/8 of the response of that loop to a typical auto.

In a similar manner, sensitivity affects the effective length of a loop, e.g. the distance from where a vehicle is first detected until that vehicle is no longer detected. At typical sensitivity settings, the effective length of a 6'X6' loop can easily vary from two feet to nine feet, depending on the response of that loop to vehicles and the sensitivity setting. Since the loop length must be subtracted from the length calculated by multiplying speed times detection time, calculated vehicle lengths will be wrong by the amount the effective loop length varies from the loop length used in calculations. For accurate vehicle length measurements, setting the sensitivity for each loop at about 1/8 of the response of that loop to a typical auto will cause effective loop lengths to be consistent from loop to loop.

The effective length of the sensor varies with vehicle type. If effective length of a loop is at 6 feet for autos, it will likely be near three feet for trucks. In general there is nothing a system operator can do to correct for this.

Vehicle Length. While length measurement due to detector imprecision is generally not related to the vehicle length, the percent error for small vehicles will be larger than those of longer vehicles because they occupy the loop for a shorter period of time. Detector scan time and vehicle speed are more likely to cause errors. The study will focus on length errors, but acknowledges that larger vehicles are expected to generally have smaller percent errors.

Magnetic Field Noise. Magnetic field noise picked up by the loop will add to or subtract from vehicle effects on a loop and cause random variations in when a vehicle is detected and in when that vehicle is no longer detected. These variations can cause significant error in speed measurement and vehicle length measurements. Quadrupole loops can be used to dramatically lower the amount of net noise picked up by a loop.

2.5 Length Classification Issues

While past published research has produced some guidance on LBVC, no substantial studies have considered LBVC among several different functional classes. This section contains references that can provide a starting point for the development of length-based classification schemes for this project.

The *Traffic Monitoring Guide*¹⁰ addresses length-based classification in a few different sections, but most prominently in Section 4 – Vehicle Classification Monitoring. This section presents a length-based classification scheme reprinted in Table 2.3 as reported in the *Traffic Monitoring Guide*.

Table 2.3: Length-Based Classification Boundaries

Classification	Lower Length Bound	Upper Length Bound
	>	< or =
Passenger vehicles	0 m (0 ft)	3.96 m (13 ft)
Single unit trucks	3.96 m (13 ft)	10.67 m (35 ft)
Combination trucks	10.67 m (35 ft)	18.59 m (61 ft)
Multi-trailer trucks	18.59 m (61 ft)	36.58 m (120 ft)

Source: Traffic Monitoring Guide (2001)

The *Traffic Monitoring Guide* acknowledges that this scheme has significant errors and attempts to determine the misclassification errors this scheme creates. These errors are shown in Table 4. The shaded cells are correct classifications. Significant errors with Single unit trucks classified as passenger vehicles, Combination trucks classified as multi-trailer trucks, and multi-trailer trucks classified as combination trucks were the most significant errors. These errors could be adjusted by changing the classification boundaries, but not eliminated.

Table 2.4: Misclassification Errors Due to Vehicle Length Classification

		Classification based on Total Vehicle Length			
		Passenger Vehicle	Single unit trucks	Combination trucks	Multi-trailer trucks
Classification Based on Configuration and Number of Axles	Single unit trucks	17.7%	81.9%	0.4%	0.0%
	Combination trucks	0.0%	1.8%	84.2%	14.0%
	Multi-trailer trucks	0.0%	0.1%	20.8%	79.1%

Source: Traffic Monitoring Guide (2001)

¹⁰ Federal Highway Administration. (2001). *Traffic monitoring guide*. US Department of Transportation.

The *AASHTO Guidelines*¹¹ observes that axle-based and LBVC represent distinct approaches to classification and do not produce systems that are uniform subsets of each other. When choosing between the two approaches, *Guidelines* recommends that consideration be given to whether the intended applications of the data warrant the use of the more complex axle-based approach. It also observes that, under some conditions (such as unstable flow), LBVC may be more practical than axle-based classification.

Guidelines recommends that, when using LBVC, three length classes be used, corresponding roughly to axle classes (AC) 1 – 3, 4 – 7, and 8 – 13, with a possible fourth class obtained by splitting the last of these classes. It also recommends that the lengths used for distinguishing between classes be the lengths that are measured by the detection devices (e.g., magnetic lengths) rather than the physical length of the vehicle; and that each state perform its own calibration tests for each technology to determine the appropriate lengths corresponding to each class given the vehicle mix operating in the state. *Guidelines* also recommends that separate sets of load spectra be collected and saved for each set of (axle-based or length-based) vehicle classes used by a state. Finally, for Federal reporting purposes, the *Guidelines* recommends the use of length-class factors for converting estimates of AADT by length class to estimates of AADT by six sets of axle classes (1, 2, 3, 4, 5 – 7, and 8 – 13) and presents a procedure for developing these factors.

The *Traffic Detector Handbook*¹² has substantial resources about loop configurations, but it largely does not address classification of vehicles by length. The Vehicle Classification Devices section of Traffic Counting and Vehicle Classification in Chapter 3 suggests that classification is normally done using loops and axle sensors. There is one reference in Chapter 3 to using waveform analysis on inductive loop responses to vehicles to separate vehicles into at least four classes.

The *Traffic Detector Handbook* gives a quite complete citation of the things that will affect vehicle speed measurement and vehicle length measurement, but it doesn't provide any real guidance on how to get consistent results from location to location (using existing infrastructure) with respect to length-based vehicle classification. Chapter 3 does say how to design a system to get relatively accurate speed monitoring results. Chapter 6 on Detector Maintenance gives much guidance on eliminating operational problems but doesn't really address LBVC.

Although most vehicle classification has traditionally been axle based, Vandervalk and Weinblatt¹³ found that when using inductive loops and piezos, motorcycles can be distinguished from other vehicles on the basis of magnetic length, not axle spacing. Also, the threshold for distinguishing motorcycles should be set at six or seven feet. Wide inductive loops used with upgraded electronics that minimize crosstalk between installations in adjacent lanes and used

¹¹ Vandervalk-Ostrander A., Turner S., Hallenbeck M., & Wilkinson J. (2009). *AASHTO guidelines for traffic data programs*. American Society of State Highway and Transportation Officials.

¹² Klein, L., Mills, M., & Gibson, D. (2006). *Traffic detector handbook: Third edition—Volume I*. Federal Highway Administration.

¹³ Cambridge Systematics, Inc. (2010). *Counting Motorcycles*. National Cooperative Highway Research Program.

with full lane-width piezos are particularly recommended as the most effective technology for detecting and distinguishing motorcycles.

FHWA¹⁴ conducted a scanning tour of five European countries to review traffic counting programs was conducted (Netherlands, Germany, Switzerland, France and England). At that time, four of these countries (all but England) had programs for automated collection of length-class data, two (France and England) had programs for automated collection of axle-class data, and two (Germany and Switzerland) had programs for manual collection of axle-class data. The length-class data was collected for three or, in the case of Switzerland, four length classes. (The extra class in Switzerland was intended for motorcycles, but was said not to work very well.) The report does not provide specifics about the applications of the length-class data.

Absolute values of boundaries between vehicle length classes vary by technology because the effective length of vehicles varies by technology. Magnetic sensors such as GTT Microloops measure the length of taller vehicles more accurately than they measure the length of shorter vehicles. Also, magnets carried by vehicles will impact the measured length of vehicles. Magnets usually reduce the effective length of the vehicle and, particularly for autos, may reduce a vehicle's effective length by 50 percent.

Vehicle length measurement accuracy is a function of the accuracy of speed measurement as well as a function of the accuracy of measuring time over sensor. Boundaries are best set where inaccuracies do not dramatically skew the numbers of vehicles in any class.

2.6 Inductive Signature-Based Detectors

The literature search found inductive signature-based loop detectors offer potentially improved vehicle classification by examining the full inductive signatures; rather than traditional loop detectors that only report a binary state, either occupied or empty. In the process of detecting vehicles, these detectors measure the loop's inductance hundreds of times per second. These inductive measurements can be captured and integrated to form an "inductive signature" for each passing vehicle. Inductive signature-based classification seeks to identify characteristic features of these signatures to classify vehicles. Inductive signature based classification has been a subject of research for almost 30 years, but has not entered mainstream practice. It requires new detector hardware in the controller cabinets and is only partially compatible with the existing infrastructure.

Several papers present effectively a proof of concept employing a very small validation data set of fewer than 100 vehicles, e.g., Reijmers¹⁵, Gajda et al.¹⁶, Cheung et al.¹⁷. Only slightly more

¹⁴ Federal Highway Administration, (1997). *FHWA study tour for European traffic monitoring programs and technologies*. FHWA's Scanning Program. U.S. Department of Transportation.

¹⁵ Reijmers, J. (1979). On-line vehicle classification. *Proceedings of the International Symposium on Traffic Control Systems*. 2B, 87–102. Institute of Transportation Studies. University of California at Berkeley.

¹⁶ Gajda, J., Sroka, R., Stencel, M., Wajda, A., & Zeglen, T. (2001). A vehicle classification based on inductive loop detectors. *Proceedings of IEEE Instrumentation and Measurement Technology Conference*. Budapest, Hungary. May 22-23.

ambitious, Sun and Ritchie¹⁸ compared performance against a manually validated data set of 300 vehicles from two detector stations. Oh et al.¹⁹, continued the work at a new detector station and used a validation set of 340 vehicles. Separately, Ki and Baik²⁰ developed a similar classification tool and validated it against a set of 622 vehicles, which were apparently manually validated. For these three latter studies, it appears that all of the data come from uncongested conditions, with long vehicles making up less than 10 percent of the flow.

In recent years, a few products have been brought inductive signature based classification products to market. The following products have been identified.

- IST Detector Card
- PEEK ADR 6000/IDRIS
- Diamond iLoop

Of these products, the PEEK ADR 6000 is currently the most widely used. The Diamond Phoenix iLoop is new, having only been marketed since June 2010. While these sensors have the capability to potentially produce more accurate vehicle classification, their ability to determine length is generally no better than traditional inductive loops. For at least two of these detectors, the additional capabilities for classification come from cross-referencing a table of historical manually classified vehicles. Thus, while these sensors may provide improved classification over traditional loops, they do not provide significantly better length-based classification.

Another important note related to these sensors is that they each use a different type of loop configuration. The Blade loop that is sometimes used with the IST card is an elongated quadrupole loop that stretches across the lane. Tok and Richie²¹ found that this technology had the potential to provide improved classification including information about the vehicle type based on the drive unit body. The system categorized 306 out of 309 axle-based classifications correctly, 186 out of 219 drive unit bodies correctly and 116 out of 138 trailer unit bodies correctly. These results required significant calibration and the development of a large reference table that was specifically tailored to the test site. The results are encouraging, but the product is currently only in a prototype phase.

¹⁷ Cheung, S., Coleri, S., Dundar, B., Ganesh, S., Tan, C., & Varaiya, P. (2005). Traffic measurement and vehicle classification with single magnetic sensor. *Transportation Research Record*, 1917, 173–181.

¹⁸ Sun, C., & Ritchie, S. (2000). Heuristic vehicle classification using inductive signatures on freeways. *Transportation Research Record*, 1717, 130–136.

¹⁹ Oh, S., Oh, C., & Ritchie, S. (2002). Real-time traffic measurement from single loop inductive signatures. *Transportation Research Record*, 1804, 98–106.

²⁰ Ki, Y., & Baik, D. (2006). Vehicle-classification algorithm for single-loop detectors using neural networks. *IEEE Transactions on Vehicular Technology*. 55(6), 1704–1711.

²¹ Tok, Y. C. A. (2008). *Commercial vehicle classification system using advanced inductive loop technology* (UCTC Dissertation No. 161). University of California Transportation Center.

Alternatively, the PEEK ADR 6000/IDRIS product uses quadrupole loops. Regarding quadruple loops, *The Traffic Detector Handbook*²² reports that:

[The dual fields] reinforce each other, improving the capability to detect small vehicles. The center wires counteract the fields of the outer wires, which have their current flowing in the opposite direction from the center wires. The influence of the outer fields is diminished, thereby reducing the possibility of splashover.

These loops are more time intensive to install, but generally require similar materials and construction methods to traditional loops.

The third inductive signature-based classifier that was identified is the Diamond iLoop. This product is unique in that it uses standard loops (6-foot x 6-foot square or round loops). It has the capability to add other loop types, but a new vehicle reference table would have to be established to generate classifications.

2.7 Non-Loop Detectors

The literature search found several non-loop detectors on the market can report vehicle lengths. Various technologies have been used, but common ones are magnetometers and sidereflect radar sensors.

Two commonly used sensors for travel monitoring are the SmartSensor 105 or HD by Wavetronix and the RTMS G4 by ISS (formerly EIS). These sensors both provide length-based classification data, although the specific algorithms are proprietary. While the sensors often provide reasonable counts and speed estimates in aggregate data, per-vehicle analysis has shown that the aggregate data allow over-counting errors to cancel under-counting errors and that individual vehicle on-times can be subject to large errors (see, e.g., Zwahlen et al.²³, Coifman²⁴). In the NIT Phase 3 study (TPF-5(171)), SRF found that the Wavetronix SmartSensor HD could report absolute average passenger lengths within 1.5 feet of the actual length and trucks within 2.5 feet of the actual length.

Zwahlen et al.²⁵ evaluated the Wavetronix SmartSensor Model 105 (predecessor to the SmartSensor HD) in uncongested, low volume traffic, with low truck flows. While these conditions should lead to favorable performance by the sensor, after comparing the classification results against manually generated ground truth data the authors concluded that, "vehicle classification is unreliable; the fraction of trucks in a lane can be severely overestimated or

²² Klein, L., Mills, M., & Gibson, D. (2006). *Traffic detector handbook: Third edition—Volume I*. Federal Highway Administration.

²³ Zwahlen, H. T., Russ, A., Oner, E. & Parthasarathy, M. (2005). Evaluation of microwave radar trailers for non-intrusive traffic measurements. *Transportation Research Record*, 1917, 127–140.

²⁴ Coifman, B. (2006). Vehicle level evaluation of loop detectors and the remote traffic microwave sensor. *Journal of Transportation Engineering*, 132(3), 213–226.

²⁵ Ibid.

underestimated." Trucks were undercounted by as much as 80 percent in the worst case and "at this time, the system does not reliably estimate the number of trucks in the traffic stream."

Finally, French and French²⁶ examined the performance of RTMS and Wavetronix Smartsensor 105, including vehicle classification, at four temporary locations and three fixed locations. Even though manufacturer representatives calibrated the detectors, the reported truck counts from the non-intrusive detectors were typically off by a factor of two and sometimes as much as ten. Almost all of the test locations were characterized by low truck flows, below five percent of the traffic.

2.8 Uses for Length-Based Classification Data

*The FHWA Traffic Monitoring Guide*²⁷ describes several common uses for classification data:

- Pavement design
- Pavement management
- Scheduling the resurfacing, reconditioning, and reconstruction of highways based on projected remaining pavement life
- Prediction and planning for commodity flows and freight movements
- Provision of design inputs relative to the current and predicted capacity of highways
- Development of weight enforcement strategies
- Vehicle crash record analysis
- Environmental impact analysis, including air quality studies
- Analysis of alternative highway regulatory and investment policies

One of the focuses of this project is to develop schemes that would allow length-based classification to replace some of the axle-based data collection. However, some error is introduced in this conversion and the quality of this converted data must be documented with metadata.

The need for more classification is derived from the uses of the data. Traditionally, the FHWA 13 class scheme has been regarded as the standard method for collecting classification data. Despite this fact, some data applications could use length-based data to supplement or replace axle-based data. One problem with axle-based data is that it is typically much more costly to collect than length-based data. Conversely, length-based methods are widespread and inexpensive.

One major use of classification data is reporting to the Highway Performance Monitoring System (HPMS). The HPMS requires the following vehicle classes:

- Motorcycles (Class 1)
- Passenger Cars (Class 2)

²⁶ French, J., & French, M. (2006). *Traffic data collection methodologies*. Harrisburg, PA: Pennsylvania Department of Transportation.

²⁷ Federal Highway Administration. (2001). *Traffic monitoring guide*. US Department of Transportation.

- Light Trucks (Class 3)
- Buses (Class 4)
- Single-Unit Trucks (Classes 5 to 7)
- Combination Trucks (Classes 8 to 13)

Procedures exist for converting length-based data to estimates of vehicles belonging to these six classes. One potential area of conflict is between buses and single unit trucks. Also, passenger cars and light trucks pulling trailers could easily be classified as a larger vehicle. It is anticipated that there will be a significant amount of overlap at the edges of the class bins; this project will quantify the effects of these phenomena.

2.9 Literature Review Summary

Some literature documents proposed classification schemes, but a comprehensive effort to establish LBVC boundaries across several states has not been conducted. Also, review of the existing literature did not find any research that has defined length-based class bins by functional class.

Even though there is a wealth of information about different types of loops configuration methods, no study has directly compared different loop types and characteristics. Generally, state DOTs have standardized practices for loop installation and most agencies use similar methods.

Chapter 3: Length-Based Vehicle Classification Schemes

This section describes and evaluates alternative LBVC schemes and then presents recommendations on their application.

3.1 Development and Evaluation of LBVC Schemes

The first three subsections below contain discussions of the LBVC schemes that were evaluated, the data used for those evaluations, and the axle-classification algorithm that was used as the basis for these evaluations. The remaining two subsections contain discussions of the evaluations of the schemes – first using combined data from a set of 13 Long Term Pavement Performance program (LTPP) sites, and then using data from these sites individually, from 11 Michigan DOT WIM sites individually, an additional analysis of a site in an urbanized area.

3.1.1 Length-Based Classification Schemes

Figure 3.1 shows three LBVC schemes that were considered in the course of the study. Other schemes were considered in an interim phase and included different class breakdowns.

Scheme 1 uses four length bins. Letters are used for the bins to avoid confusing length bins with axle classes, which are numbered; and the letters are chosen to correspond to descriptions of the bins – MotorCycles, Short, Medium and Long. The figure also shows the axle classes to which each length bin is designed to correspond. Separate axle classes – 2T, 3T and 5T – are used to distinguish Class 2, 3 and 5 vehicles with light trailers from vehicles without trailers. In Scheme 1, the S bin is designed to correspond to Class 2 and 3 vehicles, but the M bin is designed to correspond to Classes 2T, 3T and 5T as well as Classes 4 - 7.

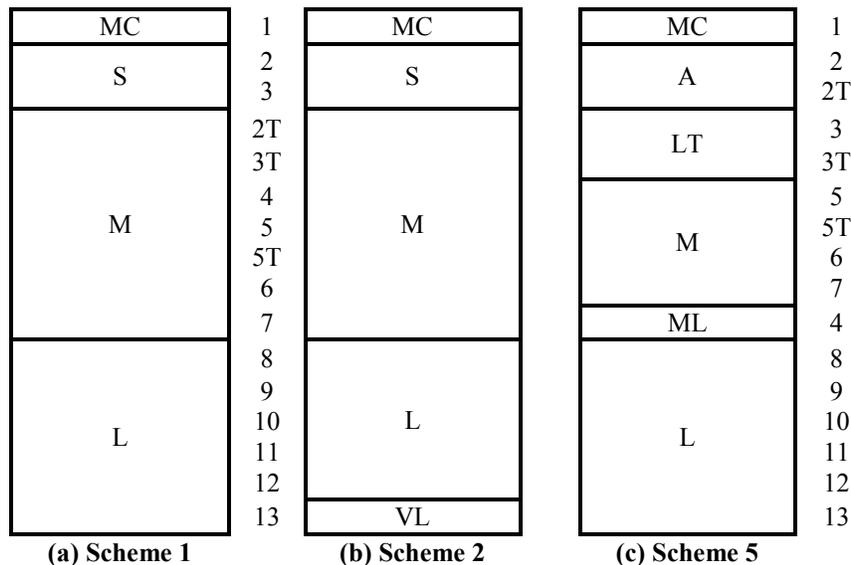

Figure 3.1: LBVC Schemes 1, 2 and 5

Scheme 2 is obtained from Scheme 1 by splitting the L bin into an L bin and a VL (very long) bin. This scheme is of interest in areas where long (e.g., greater than 85 feet) multi-trailer Class 13 vehicles operate routinely. In concept, the VL bin can also be used to distinguish multi-trailer combinations (Classes 11 – 13) from single-trailer combinations (Classes 8 – 10); however, because there is a very substantial overlap in the lengths of vehicles in Classes 9 – 12, this use of the VL bin appears to be of limited value and was not investigated in this study.

The third scheme in Figure 3.1, Scheme 5, is designed to produce data that can be used to estimate vehicle-miles of travel (VMT) by the six vehicle classes for which VMT estimates are required by FHWA's HPMS. The letters used correspond to the names MotorCycles, Autos, Light Trucks, Medium, Medium Long, and Long, with the Medium Long bin meant to correspond to buses. The current edition of the *HPMS Field Manual* is ambiguous as to which of the six vehicle classes should include the VMT of automobiles with trailers and light trucks with trailers (Classes 2T and 3T); however, in Scheme 5, we have assumed that these vehicle classes should be treated as autos and light trucks, respectively, and so the figure indicates that these classes correspond to the A and LT bins.

Other schemes that were considered were developed by adding a Medium Long (bus) bin to Schemes 1 and 2 and a Very Long bin to Scheme 5.

3.1.2 Data

The principal source of data used in this study was data collected at selected LTPP WIM sites. Additional data, obtained from several Michigan DOT WIM sites that use quartz detectors, was used for some supplementary analyses. The data obtained from these two sources are described briefly below.

LTPP Data

The principal source of data used in the study was a set of per-vehicle record (PVR) data for all vehicle classes obtained from LTPP WIM sites²⁸ that were selected on the basis of the quality of data collected at those sites. For this purpose, Calibration and Validation reports prepared by Applied Research Associates (ARA)²⁹ for 24 LTPP sites were reviewed and 13 sites in 12 states were selected for use in the study. The selected sites had all passed the LTPP post-calibration validation test for length measurements and also performed well on a validation test of vehicle classification. To limit the effects of any post-validation calibration drift, all tests performed using the data for a particular LTPP site used only data that was collected during the first two full calendar months following the calibration test performed at that site (e.g., for a site that was calibrated during May 2010, only data collected in June and July, 2010, was used).

28 Data provided by Deborah Walker and Sean Lin, FHWA LTPP, Fall 2011.

29 Applied Research Associates. LTPP weigh-in-motion field calibrations and validations. Washington, DC: Federal Highway Administration. Separate reports were prepared for each of 24 LTPP sites that were evaluated between May 2010 and April 2011.

We received 4,245,260 records of vehicle data for the 13 resulting data collection periods. Of these records, 131,647 were excluded from the analyses because of questionable length information (total length greater than twice the sum of the axle spacings or less than 80 percent of the sum of the axle spacings).

Figure 3.2 shows the length ranges observed in the LTPP data for each of the 16 axle classes. Each end of the bar and histogram were truncated at the point where the histogram was one standard deviation of the average length per class. This figure illustrates the overlapping nature of attempts to map axle-based classification to length bins.

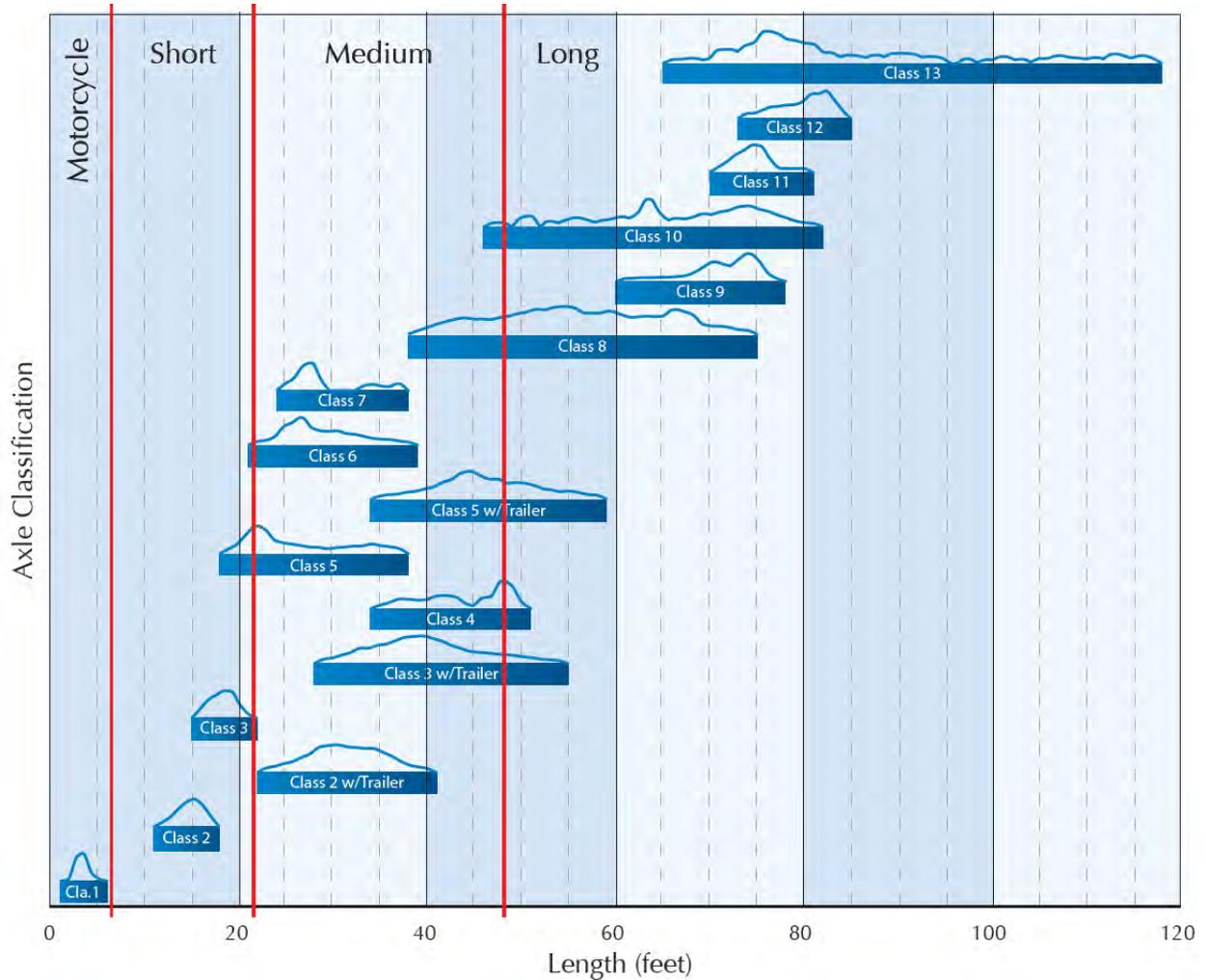

Figure 3.2: Vehicle Length by Axle Classification

Michigan Data

Some supplementary analyses were performed using PVR data collected during the fall of 2011 from 11 WIM sites in Michigan that use quartz piezoelectric sensors³⁰. The Michigan sites selected are all on roads that are known to carry extra truck traffic during harvest season or on recreational roads on which relatively high volumes of travel trailers are operated.

3.1.3 Axle Classification

The results of all tested LBVC schemes were evaluated by comparing the length bin assignments that they produce to axle class assignments produced by a modified version of the LTPP classification scheme. The scheme used, shown in Table 3.1, differs from the standard LTPP scheme³¹ in several ways:

- Several changes were made (shown in pink and blue) to the rules for classifying Class 7, 10 and 13 vehicles, as recommended by TRAC³²
- A rule was added for handling 13-axle multi-trailer (Class 13) vehicles (shown in orange)
- Separate classes were established for 2-axle vehicles with light trailers (Classes 2T, 3T and 5T, shown in light green) to distinguish these vehicles from those without trailers
- For reasons discussed below, several changes (shown in dark green) were made to the rules for distinguishing Class 2, 3 and 5 (and 2T, 3T and 5T) vehicles

The classification scheme shown in Table 3.1 was applied to both the LTPP data and the Michigan data.

The issue as to how to use automated techniques to distinguish between Class 2, 3 and 5 vehicles is one that appears to have no good solution. Distinctions between Classes 2 and 3 appear to have only limited practical value (and, in recent years, the distinction between these two classes has become increasingly blurred). However, the distinction between Class 2 and 3 vehicles, which produce no significant pavement damage, and Class 5 vehicles, which produce a modest amount of such damage, is of more practical interest.

One possible technique for distinguishing Class 5 vehicles from Class 2 and 3 vehicles is to use a diagonal piezo to identify axles with dual wheels. However, this option is not currently used to any significant extent.

LTPP has chosen to distinguish Class 5 from Classes 2 and 3 entirely on the basis of gross vehicle weight (GVW). This is an option that can be used only at WIM sites. Moreover, a review

30 Data provided by James Kramer, Michigan DOT, Fall 2011.

31 The data received from LTPP included AC assignments that had been developed using the standard LTPP algorithm for five of the sites and using a moderately different (and unspecified) algorithm for the other seven sites.

32 Washington State Transportation Center and Applied Research Associates. (2010, June). Verification, refinement and applicability of LTPP classification scheme (Draft interim report prepared for LTPP).

of data from limited classification tests performed at 13 LTPP sites³³ indicates that, although this procedure produces reasonably good classifications, it is a poor substitute for ground truth – of 156 Class 5 vehicles observed at these sites during the tests, 20 were misclassified as Class 3 (and several others were misclassified as either Class 4 or Class 8).

Because the LTPP classification scheme uses weight data (which would not be available at non-WIM sites) and does not provide for significantly improved classification over a traditional axle-based scheme for differentiating Class 3 and Class 5 vehicles, it was decided that a more appropriate standard of comparison would make distinctions between Classes 2, 3 and 5 entirely on the basis of axle spacing. This is comparable to how classification is usually done at non-WIM classification sites and also at most or all non-LTPP WIM sites. After reviewing manufacturers' data³⁴ on the axle spacing of various two-axle vehicles, it was determined that a spacing of 10.4 feet between Axle 1 and Axle 2 is the appropriate threshold for distinguishing between Classes 2 and 3, and a corresponding spacing of 13.0 feet is appropriate for distinguishing between Classes 3 and 5. These two thresholds were used as the basis for the revisions to the rules for distinguishing Class 2, 3 and 5 (and 2T, 3T and 5T) vehicles shown in Table 3.1 in dark green highlight.

3.1.4 LBVC Scheme Evaluations Using LTPP Data from All Sites Combined

The first set of evaluations of LBVC schemes used combined data from all 13 LTPP sites – four million PVRs for vehicles that were assigned to one of 16 ACs using the algorithm shown in Table 3.1. As previously stated, all PVR data from a given site was collected during the first two full calendar months following calibration of that site.

The LTPP data provides vehicle length to the nearest foot. For our analyses, it was assumed that, for each axle class, the lengths of vehicles that are reported is actually uniformly distributed within +/- 0.5 feet.

The results of the evaluations are presented below.

Scheme 1

The first analysis involved using combined data from the 13 LTPP sites to determine the boundaries of the four Scheme 1 length bins that provide the best match between the counts of vehicles in each bin and the counts of vehicles belonging to the axle classes corresponding to that bin. The upper boundary of the MC bin was estimated to the nearest 1/4 foot, and the other boundaries were estimated to the nearest 1/2 foot. The resulting boundaries are:

- MC/S – 6.75 feet
- S/M – 22 feet
- M/L – 49 feet

³³ Applied Research Associates. *LTPP weigh-in-motion field calibrations and validations*. Washington, DC: Federal Highway Administration.

³⁴ Data supplied by Gene Hicks, Minnesota DOT, personal communication, 2011.

Table 3.2 shows a summary of the results of using these boundaries for the length bins. For each axle class, the table shows the total number of vehicles assigned to that class by the classification algorithm, the numbers of these vehicles that are assigned to each of the four length bins, and the corresponding percentages of vehicles in the class that are assigned to each of the four bins. Thus, the use of a 6.75 foot boundary between the MC and S bins results in assigning 6,047 motorcycles to the MC bin and 472 to the S bin, with this last figure being roughly balanced by the 365 autos that are assigned to the MC bin. The resulting MC bin count of 6,765 vehicles is a reasonable approximation to the WIM count of 6,519 motorcycles obtained using GVW data.

Table 3.2 shows results for 4,040,931 vehicles that were successfully classified by the algorithm presented in Section 2.1.3; it excludes another 76,241 vehicles that could not be classified by that algorithm, and records for another 131,647 vehicles that were dropped from the data set because they contained length data that appeared to be unreliable.

Table 3.1: Axle Classification Scheme

Rule	Class	Vehicle Type	No. Axles	Spacing 1	Spacing 2	Spacing 3	Spacing 4	Spacing 5	Spacing 6	Spacing 7	Spacing 8	Spacing 9	Spacing 10	Spacing 11	Spacing 12	Gross Weight Min-Max	Axle 1 Weight Min *
1	1	Motorecycle	2	1.00-5.99												0.10-3.00	
2	2	Passenger Car	2	6.00-10.40												1.00>	
3	2T	Car w/ 1 Axle Trailer	3	6.00-10.40	6.30-25.00											1.00-19.99	
4	2T	Car w/ 2 Axle Trailer	4	6.00-10.40	6.30-30.00	1.00-11.99										1.00-19.99	
5	3	Other (Pickup/Van)	2	10.41-13.40												1.00>	
6	3T	Other w/ 1 Axle Trailer	3	10.41-13.40	6.30-25.00											1.00-19.99	
7	3T	Other w/ 2 Axle Trailer	4	10.41-13.40	6.30-30.00	1.00-11.99										1.00-19.99	
8	3T	Other w/ 3 Axle Trailer	5	10.41-13.40	6.30-25.00	1.00-11.99	1.00-11.99									1.00-19.99	
9	4	Bus	2	23.10-40.00												12.00>	
10	4	Bus	3	23.10-40.00	3.00-7.00											20.00>	
11	5	2D Single Unit	2	13.41-23.09												3.00>	
12	5T	2D w/ 1 Axle Trailer	3	13.41-23.09	6.30-30.00											6.00-19.99	2.5
13	5T	2D w/ 2 Axle Trailer	4	13.41-23.09	6.30-40.00	1.00-20.00										6.00-19.99	2.5
14	5T	2D w/ 3 Axle Trailer	5	13.41-23.09	6.30-35.00	1.00-25.00	1.00-11.99									6.00-19.99	2.5
15	6	3 Axle Single Unit	3	6.00-23.09	2.50-6.29											12.00>	3.5
16	7	4 Axle Single Unit	4	6.00-23.09	2.50-6.29											12.00>	3.5
17	7	5 Axle Single Unit	5	6.00-23.09	2.50-6.29	2.50-6.29	2.50-15.00									20.00>	3.5
18	7	6 Axle Single Unit	6	6.00-23.09	2.50-6.29	2.50-6.29	2.50-6.29	2.50-15.00								12.00>	3.5
19	7	7 Axle Single Unit	7	6.00-23.09	2.50-6.29	2.50-6.29	2.50-6.29	2.50-6.29	2.50-15.00							12.00>	3.5
20	8	Semi, 2S1	3	6.00-23.09	11.00-45.00											20.00>	3.5
21	8	Semi, 3S1	4	6.00-26.00	2.50-6.29	13.00-50.00										20.00>	5
22	8	Semi, 2S2	4	6.00-26.00	8.00-45.00	2.50-20.00										20.00>	3.5
23	9	Semi, 3S2	5	6.00-30.00	2.50-6.29	6.30-65.00	2.50-11.99									20.00>	5
24	9	Truck+Full Trailer (3-2)	5	6.00-30.00	2.50-6.29	6.30-50.00	12.00-27.00									20.00>	3.5
25	9	Semi, 2S3	5	6.00-30.00	16.00-45.00	2.50-6.30	2.50-6.30									20.00>	3.5
26	10	Semi, 3S3	6	6.00-26.00	2.50-6.30	6.30-45.00	2.50-11.99	2.50-10.99								20.00>	5
27	10	Truck(3)/trailer(4)	7	6.00-26.00	2.50-6.30	6.30-45.00	2.50-11.99	2.50-10.99	2.50-10.99							20.00>	5
28	10	Truck(4)/trailer(3)	7	6.00-26.00	2.50-6.30	2.50-6.30	6.30-45.00	2.50-10.99	2.50-10.99							20.00>	5
29	10	Truck(3)/trailer(5)	8	6.00-26.00	2.50-6.30	6.10-45.00	2.50-11.99	2.50-10.99	2.50-10.99	2.50-15.00						20.00>	5
30	10	Truck(4)/trailer(4)	8	6.00-26.00	2.50-6.30	2.50-6.30	6.10-45.00	2.50-10.99	2.50-10.99	2.50-15.00						20.00>	5
31	11	Semi+FullTrailer, 2S12	5	6.00-30.00	11.00-26.00	6.00-20.00	11.00-26.00									20.00>	3.5
32	12	Semi+FullTrailer, 3S12	6	6.00-26.00	2.50-6.30	11.00-26.00	6.00-24.00	11.00-26.00								20.00>	5
33	13	7 Axle Multi	7	6.00-45.00	3.00-45.00	3.00-45.00	3.00-45.00	3.00-45.00	3.00-45.00							20.00>	5
34	13	8 Axle Multi	8	6.00-45.00	3.00-45.00	3.00-45.00	3.00-45.00	3.00-45.00	3.00-45.00	3.00-45.00						20.00>	5
35	13	9 Axle Multi	9	6.00-45.00	3.00-45.00	3.00-45.00	3.00-45.00	3.00-45.00	3.00-45.00	3.00-45.00	3.00-45.00					20.00>	5
36	13	10 Axle Multi	10	6.00-45.00	3.00-45.00	3.00-45.00	3.00-45.00	3.00-45.00	3.00-45.00	3.00-45.00	3.00-45.00	3.00-45.00				20.00>	5
37	13	11 Axle Multi	11	6.00-45.00	3.00-45.00	3.00-45.00	3.00-45.00	3.00-45.00	3.00-45.00	3.00-45.00	3.00-45.00	3.00-45.00	3.00-45.00			20.00>	5
38	13	12 Axle Multi	12	6.00-45.00	3.00-45.00	3.00-45.00	3.00-45.00	3.00-45.00	3.00-45.00	3.00-45.00	3.00-45.00	3.00-45.00	3.00-45.00	3.00-45.00		20.00>	5
39	13	13 Axle Multi	13	6.00-45.00	3.00-45.00	3.00-45.00	3.00-45.00	3.00-45.00	3.00-45.00	3.00-45.00	3.00-45.00	3.00-45.00	3.00-45.00	3.00-45.00	3.00-45.00	20.00>	5

For 13 of the 16 axle classes (all but 5, 5T and 8), Table 3.2 shows a strong correspondence between axle classes and length bins, with over 88 percent of the vehicles in each of these classes being assigned to the same length bin. For the remaining three classes the correspondence is somewhat weaker – Class 5 vehicles are split 76/24 between the M and S bins, Class 5T vehicles are split 65/35 between the M and L bins, and Class 8 vehicles are split 78/22 between the L and M bins. The split for Class 3T, 89/11 between the M and L bins, is better than the splits for Classes 5, 5T and 8; but because there are a relatively large number of 3Ts in the data, this split has an observable effect on other aspects of the analysis.

The splits of Class 3T, 5, 5T and 8 vehicles have significant effects on the resulting bin boundaries. The long Class 3Ts and 5Ts that fall into the L bin tend to move the M/L boundary upward (to reduce the numbers of 3Ts and 5Ts in this bin), while the short Class 8s that fall into the M bin tend to have the opposite effect. Long 3Ts (such as light trucks with boat trailers) tend to be more common in rural areas than in urban areas, while the shortest Class 8s (predominantly tractors with a 28-foot trailer) are most common in urban areas. (Similarly, short Class 5 vehicles tend to move the S/M boundary upward; but, since the number of Class 5s is very small relative to the number of vehicles in the S bin, this effect is small.)

The 49 foot boundary between the M and L bins is higher than that suggested by previous researchers³⁵. The high boundary is primarily due to the use of data obtained exclusively from rural sites – sites at which there are a large number of relatively long Class 3T and 5T vehicles and a relatively small number of single-28 Class 5s. An appreciably lower boundary would result from a similar analysis of data from urban sites.

The last column of Table 3.2 shows total counts for four sets of axle classes. The first of these counts, for Class 1, exceeds the corresponding count for the MC bin (on the last line of the table) by 1.7 percent; while the other three counts for sets of axle classes each differ from the counts

for the corresponding length bins by less than 0.5 percent. Thus, for the selected set of rural LTPP sites, the above bin boundaries produce a reasonably good correspondence between counts of vehicles in the four length bins and counts of vehicles in the corresponding sets of axle classes.

35 Ai, Q., & Wei, H. (2010). Dual-loop length-based vehicle classification models against synchronized and stop-and-go traffic flows. Student Paper Competition. Ohio Transportation Consortium; Cornell-Martinez, C. (2006). Use of vehicle length data for classification purposes: The research and a suggested procedure. NATMEC.; Mussa, R. (2006). Analysis of classification using vehicle length: Florida case study. Presented at NATMEC; Robinson, R. (2006). Illinois DOT vehicle length classification experiences. Presented at NATMEC; and Southgate, H. F. (2006). Truck classification based on length compared with axle based classes. Presented at NATMEC.

Table 3.2: Scheme 1 Results

Axle Class	Length Bin				Total	Total
	MC	S	M	L		
1	6,047 92.8%	472 7.2%	0 0.0%	0 0.0%	6,518 100.0%	2,647,020
2	365 0.0%	2,047,028 100.0%	0 0.0%	0 0.0%	2,047,393 100.0%	
3	0 0.0%	576,945 96.2%	22,683 3.8%	0 0.0%	599,627 100.0%	
2T	0 0.0%	460 1.9%	23,820 97.6%	114 0.5%	24,393 100.0%	250,991
3T	0 0.0%	34 0.0%	66,975 88.9%	8,315 11.0%	75,323 100.0%	
4	0 0.0%	1 0.0%	10,945 89.3%	1,304 10.6%	12,250 100.0%	
5	0 0.0%	21,747 24.0%	68,682 76.0%	0 0.0%	90,429 100.0%	
5T	0 0.0%	1 0.0%	11,130 65.0%	6,005 35.0%	17,135 100.0%	
6	0 0.0%	876 3.3%	25,554 96.6%	34 0.1%	26,463 100.0%	
7	0 0.0%	41 0.8%	4,951 99.1%	7 0.1%	4,998 100.0%	
8	0 0.0%	1 0.0%	9,982 22.1%	35,133 77.8%	45,116 100.0%	1,136,402
9	0 0.0%	0 0.0%	4,946 0.5%	997,264 99.5%	1,002,209 100.0%	
10	0 0.0%	0 0.0%	317 3.1%	10,003 96.9%	10,319 100.0%	
11	0 0.0%	0 0.0%	0 0.0%	52,263 100.0%	52,263 100.0%	
12	0 0.0%	0 0.0%	0 0.0%	23,923 100.0%	23,923 100.0%	
13	0 0.0%	0 0.0%	104 4.0%	2,468 96.0%	2,572 100.0%	
Total	6,412 0.2%	2,647,603 65.5%	250,086 6.2%	1,136,831 28.1%	4,040,931 100.0%	
<u>Deviation from Corresponding AC Totals:</u>						
	-1.7%	0.0%	0.4%	0.0%		
(a) Using Scheme 1 Boundaries (6.75', 22' and 49')						

Buses

Brief consideration was given to variants of Scheme 1 that would have included a separate length bin that would have corresponded to buses. However, the LTPP data indicates that there is no vehicle length for which buses represent more than 27 percent of total vehicles. Accordingly, the

analysis of a separate length bin for buses was limited to the analysis of Scheme 5, addressed subsequently.

“Longer Combination Vehicles” and Scheme 2

Longer combination vehicle (LCV) is a term commonly used for triple trailer configurations and for many double trailer configurations that are longer than twin 28s and that have seven or more axles. Common LCVs are:

- “Rocky Mountain doubles”, usually having seven axles and consisting of a full size trailer pulling a smaller two-axle “pup” trailer;
- “Turnpike doubles”, usually having nine axles and consisting of two full size trailers; and
- “Triples”, usually having seven or ten axles and consisting of three short trailers.

Some or all of these configurations are currently subject to GVW limits of 105,500 pounds or higher on significant networks of roads in several “LCV” states between North Dakota and Oregon and Nevada, and turnpike doubles are allowed to operate at high weight limits on some toll roads in other parts of the country.

Scheme 2 differs from Scheme 1 in that it adds a VL bin in which these longer heavier vehicles can be classified – a potentially useful capability for LCV states. A brief review was conducted to determine if this bin could be used to distinguish Class 12 vehicles (and, perhaps, Class 11 vehicles) from single trailer configurations, but the overlapping length distributions of vehicles in these classes was found to limit the usefulness of such a VL bin. States with LCV may consider establishing a local VL bin that addresses vehicles that travel within their state.

Scheme 5

As stated in Sec. 3.1.2, Scheme 5 (defined in Figure 3.1) is designed to produce data that can be used to estimate VMT for the six vehicle classes for which such estimates are required by HPMS. For this scheme, combined data for the 13 LTPP sites were used to create boundaries for the length bins in the same way as for the Scheme 1 bins. The resulting boundaries for the six bins are:

- MC/A – 6.75 feet
- A/LT – 18 feet
- LT/M – 31 feet
- M/ML – 47.25 feet
- ML/L – 49 feet

The first and last boundaries are the same as the corresponding boundaries for the Scheme 1 bins, but the S/M Scheme 1 boundary of 22 feet has been replaced by new boundaries at 18, 31 and 47.25 feet. Table 3.3 shows a summary of the results of using these boundaries for the length bins.

Table 3.3 indicates that the correspondences of Class 1 to the MC bin and of Classes 8 – 13 to the L bin are just as strong as they are for Scheme 1 (in Table 3.2), and that Class 2 corresponds to the A bin nearly as strongly as it does to the S bin in Scheme 1. However, for the other axle

classes, the correspondences to length bins is much weaker than in Scheme 1; and for several classes, few if any vehicles belonging to the class also belong to the corresponding length bin as specified in Figure 3.1.

In short, the axle-class groupings required for the HPMS VMT estimates are not readily distinguished by vehicle length. Three of the HPMS groupings (autos, light trucks, and single-unit trucks) contain mixes of short and medium-length vehicles that make it difficult to distinguish the groupings from each other on the basis of length. And a fourth (buses) contains a mix of medium and medium-long vehicles that also cannot be readily distinguished from those three groupings on the basis of length.

As an example, the A bin is designed to produce a good estimate of the number of autos, with and without light trailers. It produces a reasonable estimate (2.12 million in Bin A vs. 2.07 million in Classes 2 and 2T), but only about 0.4 percent of autos with light trailers are in this length bin. Instead, nearly all Class 2T vehicles fall into the LT and M bins. As a result, Bin A vehicle counts will be totally insensitive to variations in the numbers of Class 2T vehicles.

As another example, consider the ML bin. The narrow boundaries of this bin (47.25 – 49 feet) are designed to allow it to produce a vehicle count that is a good approximation to the number of buses operating at any site. When applied to the aggregate LTPP data, it accomplishes this goal reasonably well, getting a count of 11,969 ML vehicles, which compares adequately to 12,250 buses counted at these sites. But, only 24 percent of the 12,250 buses counted at the LTPP sites actually belong to the ML bin. (Most belong to the M bin, and some to the L bin.) The ML bin contains more Class 3T vehicles than it contains buses; and the bin also contains significant numbers of Class 5T, 8 and 9 vehicles. Thus, at sites with high percentages of buses, the ML bin is likely to provide significant underestimates of the numbers of buses; and at sites with no buses, the ML bin is likely to provide significant overestimates of the number of buses.

When data from many sites are combined, as is done when VMT is estimated for a system of roads, errors will tend to cancel. So, for many road systems, bus VMT estimates derived from length classification data are likely to appear to be fairly reasonable. But, they are unlikely to be particularly accurate. And, for road systems that have particularly low (or high) percentages of buses, unless special procedures are used for collecting LBVC data, bus VMT estimates derived from LBVC data are likely to incorporate significant upward (or downward) biases.

Table 3.3: Scheme 5 Results

Axle Class	Length Bin						Total	Total
	MC	A	LT	M	ML	L		
1	6,139 94.2%	379 5.8%	0 0.0%	0 0.0%	0 0.0%	0 0.0%	6,518 100.0%	6,518
2	626 0.0%	1,913,994 93.5%	132,774 6.5%	0 0.0%	0 0.0%	0 0.0%	2,047,393 100.0%	2,071,786
2T	0 0.0%	86 0.4%	10,220 41.9%	13,866 56.8%	108 0.4%	114 0.5%	24,393 100.0%	
3	0 0.0%	201,904 33.7%	397,724 66.3%	0 0.0%	0 0.0%	0 0.0%	599,627 100.0%	674,950
3T	0 0.0%	6 0.0%	4,103 5.4%	59,577 79.1%	3,323 4.4%	8,315 11.0%	75,323 100.0%	
5	0 0.0%	658 0.7%	64,482 71.3%	25,290 28.0%	0 0.0%	0 0.0%	90,429 100.0%	139,025
5T	0 0.0%	0 0.0%	61 0.4%	9,383 54.8%	1,687 9.8%	6,005 35.0%	17,135 100.0%	
6	0 0.0%	72 0.3%	17,223 65.1%	8,895 33.6%	240 0.9%	34 0.1%	26,463 100.0%	
7	0 0.0%	7 0.1%	3,523 70.5%	1,461 29.2%	2 0.0%	7 0.1%	4,998 100.0%	12,250
4	0 0.0%	0 0.0%	28 0.2%	7,994 65.3%	2,925 23.9%	1,304 10.6%	12,250 100.0%	
8	0 0.0%	0 0.0%	37 0.1%	7,848 17.4%	2,099 4.7%	35,133 77.9%	45,116 100.0%	
9	0 0.0%	0 0.0%	8 0.0%	3,522 0.4%	1,416 0.1%	997,264 99.5%	1,002,209 100.0%	1,136,402
10	0 0.0%	0 0.0%	0 0.0%	148 1.4%	168 1.6%	10,003 96.9%	10,319 100.0%	
11	0 0.0%	0 0.0%	0 0.0%	0 0.0%	0 0.0%	52,263 100.0%	52,263 100.0%	
12	0 0.0%	0 0.0%	0 0.0%	0 0.0%	0 0.0%	23,923 100.0%	23,923 100.0%	
13	0 0.0%	0 0.0%	0 0.0%	102 4.0%	2 0.1%	2,468 96.0%	2,572 100.0%	4,040,931
Total	6,765 0.2%	2,117,104 52.4%	630,178 15.6%	138,085 3.4%	11,969 0.3%	1,136,831 28.1%	4,040,931 100.0%	
<u>Deviation from Corresponding AC Totals:</u>								
3.6% 2.1% -7.1% -0.7% -2.3% 0.0%								
(a) Using Scheme 5 Boundaries (6.75' 18', 31', 47.25', 49')								

3.1.5 Locational and Temporal Influences

To gain an understanding of how the performance of LBVC can vary from site to site, a set of evaluations of Scheme 1 was performed using data from the 13 LTPP sites individually and a second set was performed using data from the 11 Michigan sites.

Differences among LTPP Sites

The first set of site-specific analyses used data from the 13 LTPP sites individually. For each of these sites, a determination was made of the boundaries of the four Scheme 1 length bins that provide the best match between the counts of vehicles in each bin and the counts of vehicles belonging to the axle classes corresponding to that bin. The resulting boundaries for each site are shown in Table 3.4 along with the corresponding boundaries obtained when all 13 sites are analyzed simultaneously. In the table, the sites are grouped by functional system (Interstate vs. Other Principal Arterial); and, within each functional system, the sites are sequenced by the length of the boundary between the M and L bins. All sites are in rural locations.

It can be seen from Table 3.4: that the optimum value of the M/L boundary varies appreciably among the 13 sites; that the variations in the values of the other two boundaries are smaller than those for M/L boundary; and that there is a slight but inconsistent tendency for the S/M boundary to increase with the M/L boundary.

The greatest differences between the overall boundaries and the site specific boundaries were obtained for the Kansas site. The effects of using these two alternative sets of boundaries when analyzing data from a site at which the vehicles have the same length and axle class characteristics as the vehicles at the Kansas site are shown in Table 3.5.

Table 3.5(a) shows the results of using the Kansas boundaries when assigning vehicles observed at this site to length bins, and Table 3.5(b) shows the results of using the overall boundaries when performing these assignments. The bottom row of the tables shows the deviation between the number of vehicles in each length bin and the number of vehicles in the axle classes corresponding to that length bin as a percentage of the latter number. This percentage is a measure of the inaccuracies that result when length bin counts are used as estimates of the numbers of vehicles in the corresponding axle classes.

Table 3.5(a) shows that, when the Kansas length-bin boundaries are used, three of the deviations are 0.1 percent or less, while the fourth (for the M bin) is +1.4 percent. Table 3.5(b) shows that when the overall boundaries are used, the deviations are somewhat greater – the deviation for the M bin is +2.1 percent and the one for the L bin is -3.0 percent. The results of this comparison suggest that it is probably reasonable to use the overall length-bin boundaries for analyzing length data collected at most sites, but that better results can be obtained if the boundaries are designed to reflect site-specific vehicle distributions.

Table 3.4: Scheme 1 Length Boundaries for Individual LTPP Sites

State	Site	Route	Dates	Boundary Between Bins (feet)		
				MC/S	S/M	M/L
Interstate System						
Kansas	200200	I-70	Jan.-Feb. 2011	6.75	19.5	44
New Mexico	350100	I-25	Feb.-March 2011	6.5	21.5	48.5
Arkansas	50200	I-30	April-May 2011	7.5	21	49
Illinois	170600	I-57	Jan.-Feb. 2011	7	22	49
Tennessee	470600	I-40	March-April 2011	6.75	22.5	49
Colorado	80200	I-76	April-May 2011	6.25	21.5	50
New Mexico	350500	I-10	Feb.-March 2011	6.75	22	51.5
Other Principal Arterials						
Wisconsin	55010	WIS-29	May-June 2011	6.5	20	47
Indiana	180600	US-31	Dec 2010-Jan 2011	6.75	21.5	47.5
Virginia	510100	US-29 bypass	April-May 2011	6.5	22.5	48.5
Delaware	100100	US-113	Aug.-Sept. 2010	6.5	21	49
Louisiana	220100	US-171	Aug.-Sept. 2010	6.75	22.5	51
Minnesota	270500	US-2	May-June 2011	7.5	23	52.5
Overall				6.75	22	49

A review of data for the 13 sites indicates that the variation in the M/L boundary among the sites is significantly affected by the distribution of vehicles among the various axle classes, and, for most sites, particularly by the percentages of Class 3T and 5T vehicles at the site – the boundary tends to increase as the percentages in these two classes increases. The Minnesota site and the New Mexico I-10 site have the highest M/L boundaries and the highest percentages of Class 3T vehicles (3.7 percent and 3.1 percent, respectively), and the latter site also has a relatively unusual characteristic – Class 5Ts account for 35 percent of all Class 5 and 5T vehicles.

These findings suggest that special consideration should be given to roadways that experience a high percentage of vehicles operating with light trailers, such as in recreational areas where use of boat trailers is common.

Table 3.5(a)*: Scheme 1 Results for Kansas LTPP Site (Modified Boundaries)

Axle Class	Length Bin				Total	Total
	MC	S	M	L		
1	21 40.1%	32 59.9%	0 0.0%	0 0.0%	53 100.0%	53
2	32 0.0%	177,911 100.0%	1 0.0%	0 0.0%	177,944 100.0%	230,274
3	0 0.0%	51,296 98.0%	1,034 2.0%	0 0.0%	52,330 100.0%	
2T	0 0.0%	2 0.2%	973 99.5%	3 0.3%	977 100.0%	
3T	0 0.0%	0 0.0%	2,688 85.9%	442 14.1%	3,129 100.0%	10,994
4	0 0.0%	0 0.0%	230 42.0%	318 58.0%	548 100.0%	
5	0 0.0%	862 19.6%	3,537 80.4%	0 0.0%	4,399 100.0%	
5T	0 0.0%	0 0.0%	383 61.6%	239 38.4%	621 100.0%	64,625
6	0 0.0%	22 2.6%	1,258 97.4%	3 0.0%	1,282 100.0%	
7	0 0.0%	1 2.6%	37 97.4%	0 0.0%	38 100.0%	
8	0 0.0%	0 0.0%	869 26.1%	2,456 73.9%	3,324 100.0%	64,625
9	0 0.0%	0 0.0%	137 0.3%	52,949 99.7%	53,086 100.0%	
10	0 0.0%	0 0.0%	0 0.0%	532 100.0%	532 100.0%	
11	0 0.0%	0 0.0%	0 0.0%	5,155 100.0%	5,155 100.0%	64,625
12	0 0.0%	0 0.0%	0 0.0%	2,431 100.0%	2,431 100.0%	
13	0 0.0%	0 0.0%	0 0.0%	97 100.0%	97 100.0%	
Total	53 0.0	230,126 75.2	11,145 3.6	64,623 21.1	305,946 100.0%	305,946
Deviation from Corresponding AC Totals:						
	0.0%	-0.1%	1.4%	0.0%		

*Using Kansas Boundaries (6.75', 19' and 44')

Table 3.5(b): Scheme 1 Results for Kansas LTPP Site**

Axle Class	Length Bin				Total	Total
	MC	S	M	L		
1	21 40.1%	32 59.9%	0 0.0%	0 0.0%	53 100.0%	53
2	32 0.0%	177,912 100.0%	0 0.0%	0 0.0%	177,944 100.0%	230,274
3	0 0.0%	52,096 99.6%	234 0.4%	0 0.0%	52,330 100.0%	
2T	0 0.0%	24 2.4%	954 97.6%	0 0.0%	977 100.0%	
3T	0 0.0%	1 0.0%	3,017 96.4%	112 3.6%	3,129 100.0%	10,994
4	0 0.0%	0 0.0%	546 99.6%	2 0.4%	548 100.0%	
5	0 0.0%	1845 41.9%	2555 58.1%	0 0.0%	4,399 100.0%	
5T	0 0.0%	0 0.0%	519 83.6%	102 16.4%	621 100.0%	
6	0 0.0%	75 5.8%	1,207 94.1%	1 0.0%	1,282 100.0%	
7	0 0.0%	3 7.9%	35 92.1%	0 0.0%	38 100.0%	64,625
8	0 0.0%	0 0.0%	1576 47.4%	1749 52.6%	3,324 100.0%	
9	0 0.0%	0 0.0%	576 1.1%	52,510 98.9%	53,086 100.0%	
10	0 0.0%	0 0.0%	5 0.9%	527 99.1%	532 100.0%	
11	0 0.0%	0 0.0%	0 0.0%	5,155 100.0%	5,155 100.0%	
12	0 0.0%	0 0.0%	0 0.0%	2,431 100.0%	2,431 100.0%	
13	0 0.0%	0 0.0%	0 0.0%	97 100.0%	97 100.0%	
Total	53 0.0	231,986 75.8%	11,223 3.7%	62,685 20.5%	305,946 100.0%	305,946
<u>Deviation from Corresponding AC Totals:</u>						
	0.0%	0.7%	2.1%	-3.0%		

** Using Overall Boundaries (6.75', 22' and 49')

Differences among Michigan Sites

The Michigan data was collected in late 2011 by James Kramer from two sets of WIM sites that use quartz detectors. One set of seven sites on roads in agricultural areas was selected to determine whether increased truck traffic during harvest season has any effect on the performance of LBVC, and a second set of five sites on recreational roads was selected to

evaluate the effects of travel trailers on LBVC. One site belonged to both sets, so the total number of sites selected was 11.

Data from the first set of sites was collected from October 6 to 23 (during harvest season) and from November 28 to December 4 (after harvest season). Data for these two time periods are referred to as “October data” and “November/December data”, respectively. There was a significant snowstorm in Michigan on November 29-30; so, for the November/December period, only data for November 28 and December 1-4 was used. Data from the second set of sites was collected from September 1 to 6, over the Labor Day weekend.

The analysis of Michigan data focused on the boundary between the M and L bins. Since the Michigan data contained length measurements to the nearest 0.01 foot, it was decided to estimate this boundary to the nearest 0.1 foot. For sites from which data was collected during different time periods, separate boundaries were estimated for each time period.

Table 3.6 shows the M/L boundaries that were obtained for each site and time period, and it also shows the corresponding percentages of Class 3T vehicles. The M/L boundaries for the “agricultural” sites are all slightly higher for October than for November/December. However, a review of the data indicates that the primary reason for this is higher percentages of Class 3T vehicles operating in the earlier time period rather than increased use of agricultural trucks (whose lengths have little influence on the bin boundaries).

Table 3.6 shows that the percentages of Class 3T vehicles are appreciably higher at recreational sites in September than they are at any of the (mostly non-recreational sites) in later months, and the M/L boundaries exhibit a similar temporal pattern. The M/L boundaries obtained using Michigan data for October and November/December are slightly higher than the corresponding boundaries obtained using LTPP data (in Table 3.4) both when comparing ranges of values at individual sites and when comparing overall values, but the Michigan boundaries using September data (from recreational sites) is appreciably higher than corresponding values from the LTPP sites (an overall value of 55.9 feet versus 49 feet from the LTPP data).

These results suggest that it is reasonable to use the M/L boundaries obtained from national data when binning length data collected in Michigan at locations that do not have high volumes of recreational traffic or at times when the volume of recreational traffic is not high. However, use of the national boundary of 49 feet for sites and times that have high volumes of Class 3T vehicles will result in L bin vehicle counts that can be appreciable overestimates of the number of Class 8 – 13 vehicles operating at the site. For Site 4129, the national thresholds result in an L bin count that exceeds the Class 8 – 13 count by 75 percent.

Table 3.6: Scheme 1 M/L Length Boundaries for Individual Michigan Sites

Site	Route	Boundary Between M/L Bins (feet)			Percent of Vehicles In Class 3T		
		Sept.	Oct.	Nov./Dec.	Sept.	Oct.	Nov./Dec.
Non-Recreational Sites							
5019	US-127		50.8	49.3		1.9	1.1
7269	I-69		53.7	49.8		1.5	1.0
8029	US-127		48.5	46.7		0.8	0.5
8049	I-96		49.8	47.1		0.7	0.4
8129	US-127		50.7	49.5		1.5	0.8
8869	I-69		54.2	53.7		1.1	0.9
Recreational Sites							
2029	US-2	54.4			5.3		
3069	US-131	54.9			4.0		
4049	I-75	56.6			8.9		
4129	US-127	57.7			7.3		
6429	I-75	53.2	48.5	47.9	4.1	2.6	1.5
Overall							
Sept. Sites		55.9			6.0		
Oct.-Dec. Sites		50.7			49.2		
					1.3		
					0.8		

3.1.6 Urbanized Area Influence

Additional analysis was conducted to better understand how length bins would change for traffic conditions in urbanized areas because length-based data in these areas has become much more prevalent than in rural areas. Discussion with the project’s TAC showed that a majority of length-based data is collected in urban areas. Whereas it is presumed that trailers for class 3 (3T) and especially for class 5 (5T) vehicles push the M/L threshold up for rural areas higher than would be determined in rural areas. To verify this hypothesis, the project team data from an urban freeway section.

Data from MnDOT’s WIM site on TH 52 in South St Paul, Minnesota was analyzed. This site has a variety of heavy commercial vehicles from various industries and residential uses. It also serves commuter traffic from the Southeast Twin Cities Metropolitan area to Downtown St Paul. The facility is a four lane divided freeway in a suburban area.

As presented in Table 3.7, two months of data (April and May 2012) were analyzed totaling over three million records. This is comparable to the amount of LTPP site records analyzed (all sites). This site was calibrated for length and speed by driving an automobile of known length through the site five times in each lane. The speed parameter was not changed, but the loop length parameter was modified to make all vehicles report vehicles to be one foot longer than the uncalibrated WIM site. The TH 52 WIM can only report vehicle lengths to the nearest whole number foot.

Each record was reclassified based on the modified LTPP classification scheme presented in Table 3.1. New length bin thresholds calculated from this urbanized area data set are:

- S/M – 20 feet
- M/L – 43 feet

The MC/S threshold remains the same (6.5 feet). Each of the other thresholds is smaller than the length bin thresholds recommended by the LTPP analysis. These thresholds were set by determining whole number thresholds that matched as many vehicles as possible to the proper bin given the previously assumed axle class to length bin mapping.

The TH 52 analysis data was from the spring when moderate motorcycle traffic was on the road, it reports a balanced condition. In Minnesota, there are virtually no motorcycles during the winter months. However, due to length measurement errors, it is likely that some vehicles will be classified in the MC bin. Similarly, in the summer, when motorcycle use is more frequent, the given bins may underestimate motorcycles.

3.1.7 Length Bins and Axle Classes

It should be recognized that, although there is a *correspondence* between length bins and sets of axle classes, these are two different ways of classifying vehicles. Many vehicles that belong to a particular length bin (e.g., the S bin) do not belong to any of the corresponding axle classes (e.g., there are many short Class 5 vehicles that fall into the S bin). The *AASHTO Guidelines*³⁶ presents a procedure for converting estimates of AADT by length bin to estimates of AADT by axle class. This procedure can also be used to convert counts by length bin to estimated counts by axle class. In particular, it is recommended that this procedure be used if LBVC is to be used as the basis for estimating AADT by vehicle class for reporting to HPMS.

3.1.8 Estimation of Load Spectra Based on LBVC

One potential application of Scheme 1 and 2 LBVC counts is in the estimation of load spectra on a road for which vehicle lengths are available, but for which axle class counts are not. LBVC provides less detail than axle classification about the characteristics of the vehicles being classified. As a result, load spectra derived from LBVC counts are somewhat less accurate than those derived from axle classification counts. Nonetheless, load spectra derived from LBVC counts collected on a given road are likely to provide a reasonably good representation of the actual loads incurred on that road, and an appreciably better representation than can be obtained in the absence of any roadway-specific vehicle classification data.

³⁶ American Association of State Highway and Transportation Officials, *AASHTO guidelines for traffic data programs*, 2008, Sec. 5.2.4.

Table 3.7: Scheme 1 Results for MnDOT TH 52 WIM Site

Axle Class	Length Bin				Total	Total
	MC	S	M	L		
1	9,825	266	44	0	10,135	10,135
	95.0%	4.5%	0.4%	0.0%	100.0%	
2	5,031	2,547,120	360	19	2,552,530	2,928,694
	0.1%	99.9%	0.0%	0.0%	100.0%	
3	286	361,089	14,777	12	376,164	121,577
	0.0%	96.0%	3.9%	0.0%	100.0%	
2T	0	739	7,570	2,870	11,179	129,928
	0.0%	6.6%	67.7%	25.7%	100.0%	
3T	1	119	19,502	2,562	22,184	129,928
	0.0%	0.5%	87.9%	11.5%	100.0%	
4	2	195	924	592	1,713	129,928
	0.1%	11.4%	53.9%	34.6%	100.0%	
5	4	8,389	45,015	25	53,433	129,928
	0.0%	15.7%	84.2%	0.0%	100.0%	
5T	2	19	1,890	1,307	3,218	129,928
	0.1%	0.6%	58.7%	40.6%	100.0%	
6	13	1,284	23,281	75	24,652	129,928
	0.0%	5.2%	94.4%	0.3%	100.0%	
7	0	17	5,181	0	5,198	129,928
	0.0%	0.3%	99.7%	0.0%	100.0%	
8	1	44	3,790	10,793	14,628	129,928
	0.0%	0.3%	25.9%	73.8%	100.0%	
9	0	43	1,312	102,606	103,961	129,928
	0.0%	0.0%	1.3%	98.7%	100.0%	
10	0	6	22	9,694	9,722	129,928
	0.0%	0.1%	0.2%	99.7%	100.0%	
11	0	0	0	1,500	1,500	129,928
	0.0%	0.0%	0.0%	0.0%	0.0%	
12	0	0	0	117	117	129,928
	0.0%	0.0%	0.0%	0.0%	0.0%	
13	0	0	0	0	0	129,928
	0.0%	0.0%	0.0%	0.0%	0.0%	
Total	15,165	2,919,329	123,668	132,172	3,190,334	3,190,334
	0.5%	91.5%	3.9%	4.1%	100.0%	
<u>Deviation from Corresponding AC Totals:</u>						
	26.0%	0.0%	1.7%	1.7%		

(Groups separated after 6.75, 20, and 43 feet)

The procedure for using LBVC data for estimating the loads incurred on a given road is quite similar to the one for using axle classification data for this purpose, with the primary difference being the smaller number of vehicle classes distinguished. Scheme 1 distinguishes only four length bins instead of the 13 axle classes that are usually distinguished by axle classification. For each of these bins, the corresponding daily pavement load is estimated by multiplying the AADT of vehicles in this bin by the expected numbers of single, tandem, tridem and quad axles per vehicle of vehicles in this bin and multiplying those results by the load spectra of that type of axle when the axle belongs to a vehicle in this bin.

For example, consider tridem axles belonging to vehicles classified as belonging to Length Bin M. The expected number of tridem axles per vehicle in this bin in rural (or urban) areas can be derived from data collected at rural (or urban) sites with both AC and LBVC capabilities, and the load spectra of these axles can be derived from data collected at WIM sites that also have both AC and LBVC capabilities. Most tridems belonging to Bin M vehicles are likely to belong to AC 7 vehicles, though a few will belong to travel trailers that are part of Class 2T, 3T or 5T vehicles and a few could belong to short Class 10 vehicles that fall into Bin M. Accordingly, the corresponding load spectra are likely to have two peaks – one at tridem Load Range 1 (less than 12,000 pounds) representing the tridems of all empty vehicles along with the tridems of all travel trailers, and a second covering two or three higher load ranges in which the tridems of loaded AC 7 trucks will usually fall. It should be noted that this procedure for using LBVC data to estimate axle loads does not require conversion of LBVC volumes to AC volumes. Furthermore, the insertion of an extra conversion step is likely to have a slightly adverse effect on the accuracy of the resulting estimates.

3.2 Length-Based Classification Scheme Recommendations

The recommended LBVC schemes are Schemes 1 and 2, as defined in Figure 3.1. Scheme 1 is the recommended scheme for all states except for the LCV states. Scheme 1 can also be used in LCV states; but, for these states, Scheme 2 has the advantage of producing separate estimates of the number of LCVs operating at monitored sites³⁷.

For Scheme 1, the analyses performed in this study do not indicate any reason for developing different bin boundaries for different states or for different functional classes. However, they do indicate that separate sets of bin boundaries definitely should be used for sites in urbanized areas and for rural sites; and it appears that, for this purpose, sites in small urban places (i.e., places with populations below 50,000) probably are best treated as being similar to rural sites. Also, if LBVC counts are to be collected during periods of high recreational traffic at sites on roads on which trailers (e.g. boat trailers) are commonly operated, a third set of bin boundaries should be used for these sites; however, if practical, it probably is preferable to collect LBVC counts on these roads only during times of the year when minimal use is made of recreational trailers.

³⁷ Scheme 2 would also have advantages over Scheme 1 for use on turnpikes that allow the operation of turnpike doubles. However, traffic data for these roads is best collected at the entrance and exit toll booths, so there is no need for LBVC on these roads.

3.2.1 Seasonal and Geographical Variation

The analysis presented thus far is general to all seasons of the year. Some agencies may wish to better understand how the optimal bin boundaries vary seasonally and geographically. It is suggested that boundaries of 6.5 feet, 21.5 feet and 49 feet might be appropriate for rural and small urban LBVC sites on roads on which no significant use is made of recreational trailers³⁸. The limited testing performed in this study suggest that counts collected on these roads using these bin boundaries will usually provide estimates of the total number of vehicles in the axle classes corresponding to any length bin within plus/minus three percent.

Optimal bin boundaries for sites in urbanized areas may shift depending on the site. Data reviewed in the course of this study indicates that, for these sites, the third boundary (the one between the M and L bins) probably should be several feet shorter than the corresponding boundary used for rural sites. The development of bin boundaries for sites in urbanized areas will be complicated by the difficulty involved in obtaining accurate length and axle spacing data for sites in these areas.

LCV Considerations

For LCV states, the recommended scheme is Scheme 2, which consists of five bins (MC, S, M, L and VL) and four boundaries. The first three boundaries may be set to the values used for Scheme 1. The fourth boundary is designed to distinguish Class 13 LCVs from other combination vehicles. It is likely that, for any state, this boundary will depend somewhat on the LCVs operating in the state. Accordingly, this boundary probably should be set individually by each state that uses Scheme 2. It is recommended that this boundary be set to optimize the match between the number of vehicles assigned to the VL bin and the number assigned to Class 13.

38 The suggested boundaries are derived judgmentally from data in Table 2.4 to reflect composite values for the first 12 sites in the table, deleting data for the Minnesota site at which there is a relatively high volume of Class 3T vehicles.

Chapter 4: Detector Calibration Procedure

This section recommends methods for the calibration and validation of length-based vehicle detectors. Traffic detectors that measure vehicle speed and length must be calibrated in order to achieve accurate data. This section focuses on the calibration and validation of loop detectors, although concepts can be applied to non-loop sensors that are similarly configurable. Additionally, rules of thumb for loop detector setup are included at the end of this section. These recommendations were made based on feedback from the TAC and experience gained through test activities.

4.1 Recommended Calibration Process – Probe Vehicle Runs

Upon consultation with the LBVC Pooled Fund’s Technical Advisory Committee, it is recommended that a probe vehicle process be used as the primary calibration method. Other methods are presented as alternatives for when the probe vehicle method is not available.

The methodology for a probe vehicle run is that one or more vehicles of known speed and length are driven through the subject site. Since the baseline is already known, the detector is adjusted to match the known values after the run. Because there is inherent error in the detection process, multiple runs need to be averaged to get a correct calibration. This method is further explained later in this section.

Before beginning the calibration process, an appropriate calibration vehicle must be selected. A survey conducted earlier in the project revealed that agencies usually calibrate detection sites with trucks. These trucks were generally those that are available to DOTs, such as those already in their fleets. These primarily consisted of large single unit trucks (class 5 and 6) and multi-axle semis including a class 9 lowboy semi. Of these options, a class 9 with lowboy trailer is preferable both because its physical length closely matches its magnetic length and because it has a low bed. This makes the inductive signature of the vehicle well-defined. Additionally, the LBVC project found that a typical passenger vehicle may be a preferable calibration vehicle because of its similar advantages and ease of use for testing. The following text describes the finding.

Calibration Vehicle Selection

Inductive signature-based laboratory testing conducted for the LBVC project revealed that a probe vehicle calibration using a semi-tractor pulling a lowboy trailer generates a calibrated loop length very close to that of a typical automobile. Semi-tractors are long and a two-foot loop length calibration error represents only about a 3% error for this vehicle, while a two-foot error for a typical auto represents a 14% error. However, the calibration criteria should focus on absolute error, rather than percent errors. Since the semi-tractor with lowboy trailer and typical auto are measured with similar absolute error, either is recommended for probe vehicle calibration. Because semi-tractor/trailer combinations can sometimes be relatively difficult for agencies to rent or use, a typical auto is acceptable for loop detector speed and length calibration with a probe vehicle.

Depending on personnel availability, it may be possible to run multiple probe vehicles concurrently to speed the calibration process. In this case, it is important that the probe vehicle drivers and calibration operator coordinate the timing of the runs so that the operator is not overwhelmed with keeping track of the data.

4.2 Calibration Overview

Calibration is a four-step process, although each step may require multiple iterations. Briefly summarized, the process for speed and length calibration and validation is to:

1. Set up detector and input default values.
2. Perform probe vehicle runs, focusing on calibrating for speed.
3. Perform additional probe vehicle runs to calibrate loop length.
4. Perform validation runs. Accept calibration when validation runs meet the acceptable tolerance.

Vehicle speed is calibrated by determining the loop spacing (distance between the leading edges of sequential loops). Note that the loop spacing may not strictly correspond to the physical distance between the loop detectors because the magnetic fields of both loops may not be identical due to a myriad of factors that are difficult to control. This speed calibration process should be done experimentally with multiple iterations.

Once the loop spacing is determined, vehicle length may be calibrated. Vehicle speed and calibrated loop length are inputs for vehicle length. Probe vehicle speed calibration runs can be used for preliminary length calibration if the pre-calibration speed was close to the calibrated speed. A rule of thumb is that if the speed calibration changed less than 10%, the runs may be used to adjust loop length.

Similarly to the speed calibration step, the physical loop length may not be the same as the calibrated loop length because the shape of the magnetic field may be different than the expected shape. The best way to determine the calibrated loop length is to perform multiple runs.

Calibration Notes

All methods detailed in this section are recommended for use only with free-flow traffic and are most effective with low traffic volumes.

Before performing calibration, it is necessary to calibrate the probe vehicle's speedometer. Many state DOTs or highway patrol departments have set up pavement markings at precise spacing that may be used to calibrate speedometers.

Before doing probe vehicle runs, it is recommended to input default or estimated values into the detector. This speeds the calibration process because fewer iterations need to be made to reach the final acceptable calibration. Methods for determining default values are presented later in this document. Also, a laser or radar gun may be useful to determine prevailing speeds and calculate default values before performing probe vehicle runs. Once one lane is calibrated these values may be useful as default values for subsequent lanes.

4.3 Probe Vehicle Calibration Process

Select and Measure the Probe Vehicle. Select a vehicle with clearly defined front and rear ends. Measure the length of the vehicle with a tape measure. For vehicles with curved bumpers, it may be helpful to hold a plumb bob at the extents of the vehicle with the tape measure running under the vehicle.

Configure the Detector with Default or Estimated Values. Use available means to estimate loop length and spacing. Adjust parameters so that the detector reports accurate prevailing traffic speeds.

Perform Speed Calibration. Perform three probe vehicle runs at the same speed and record the detected speeds and lengths. Average the detected vehicle speeds. Multiply the loop spacing (in feet) by the ratio of actual probe vehicle speed to the average detected probe vehicle speed. Recall this earlier equation:

$$D_{cal} = D_{initial} * \frac{V_{actual}}{V_{meas}}$$

D_{cal} is the calibrated loop spacing (loop spacing that will give the correct vehicle speed)

$D_{initial}$ is the assumed initial loop spacing (loop spacing used during calibration run)

V_{actual} is the vehicle speed during calibration run

V_{meas} is the vehicle speed as measured by the device during the calibration run

Perform Length Calibration. Assuming the pre-calibrated loop spacing was within 10% of the post-calibration loop spacing, use the values from the first three probe vehicle runs to determine a calibrated loop length. Similarly to the speed calibration calculation, use the following calculation to determine a calibrated loop length.

$$L_{cal} = L_{initial} + (L_{veh\ meas} - L_{veh\ actual})$$

L_{cal} is the loop length that will result in the correct vehicle length measurement

$L_{initial}$ is the assumed initial loop length (loop length used during calibration run)

$L_{veh\ actual}$ is the actual bumper-to-bumper vehicle length

$L_{veh\ meas}$ is the vehicle length as measured by the device during the calibration run (magnetic length)

T_{detect} is the duration of vehicle detection during calibration run (generally not directly reported by the measurement device).

Then perform three additional probe vehicle runs to get a revised average detected lengths. If necessary, recalibrate loop length.

4.4 Probe Vehicle Validation Process

The general process for validating proper speed and length data is to repeat the calibration process until consistent results that are within the accuracy criteria are attained. In the interest of developing a practicable method for agencies, we recommend that each validation test be conducted at least three times without changing detector settings. Any calibration runs may be

counted as validation runs as long as changes were not made to the detector settings for the subject lane. If detector settings changes are necessary, check the detector setup procedures to make sure that setting changes on the subject lane do not affect the other lanes.

It is not feasible to obtain a statistically significant sample for validation. For the technologies tested in the LBVC project, to get a 5 percent margin of error and a 95 percent confidence interval, over 500 runs would have to be conducted.

Field testing found that the absolute average error (AAE) for loop detector speed measurements was approximately 1 mph and 1.0 feet for passenger car length measurements. The standard deviation of these errors was approximately 1 mph. For length, the standard deviation was approximately 1.0 feet for detectors that report to tenths of a foot and 1.5 feet for detectors that report to whole feet. Non-loop detectors had a standard deviation of approximately 3.0 feet and 3 mph for passenger cars.

Agencies may elect to use an allowable threshold of two standard deviations as a standard for acceptable error. This means that 95.4 percent of the loop detector readings should be within the tolerance. For length measurement, 95.4 percent of the detections should be within 2.0 feet of the baseline for loop detectors that report the baseline to a tenth of a foot and within 3.0 feet of the baseline for loop detectors that report data to a whole foot. In other words, about 19 of 20 (95%) of the runs should all be within these thresholds.

Similarly, non-loop sensors should be within 6.0 feet and 6 mph of the baseline.

There is usually not enough time to perform 20 test runs per lane. Instead, the agency may elect to conduct only three or five consecutive runs, but all runs must meet the error tolerance criteria.

4.5 Alternative Calibration Methods

1. Default Values for Loop Spacing and Loop Length

A reasonable default, and in most cases the first calibration parameter to use, is simply the known or estimated physical distance between loops (leading edge to leading edge) and the physical loop size (leading edge to lagging edge of a single loop). Under ideal conditions, this represents the best possible calibration. Unfortunately, it requires the ability to correctly locate and measure the loops. Loop detectors can be located with loop probe locating equipment, but this requires a lane closure. It also requires that the lead loop and the lag loop are identical twins. Possible common installation discrepancies that cause the vehicles to affect the lead loop differently than the lag loop are:

- Lead and lag loop are slightly different shapes or sizes
- Lead and lag loop have a different number of turns
- Nearby arrangement of reinforcing steel in the pavement affects the lead and lag loops differently
- Lead and lag loop have differing depths below the pavement surface
- Lead and lag loop are at a slightly different transverse position in the lane

Also, the detect threshold (the point on the vehicle waveform where the call is first held) on both loops must be the same. Practical experience shows that one or more of the deficiencies above are often true. If these requirements are not met, the default value method cannot be used, and the loop spacing and loop size must be set to field-calibrated values using one of the other methods rather than the physical dimensions. However, this method gives a reasonable starting point for calibration.

2. Collect Traffic Speeds with a Radar or Laser Gun

This method uses a calibrated radar gun or laser gun to measure the speed of specific vehicles and the general flow of traffic. However, attempts to measure vehicle speeds may cause vehicles to slow down as drivers see personnel working near the roadway. Ideally, the speed measurements would be taken immediately after the vehicle exits the subject loops and could be done without drivers noticing and changing speeds. If a radar gun or laser gun is being used, the operator must be located a couple hundred feet downstream of the detectors in order for the speed measurement to not be negatively impacted by the incidence angle of the gun beam. This is usually a two-person calibration effort and requires significant coordination between the two operators. It is also practical only when the traffic level is low enough that there is a five to ten-second gap between vehicles in the subject lane.

3. Video Measurement

Put a wide piece of white pavement tape on each side of the dual loop configuration (examples are lane division stripe tape or crosswalk delineation tape). The pieces of tape should be exactly 100 feet apart and perpendicular to the road. At most sites, a second set of stripes should also be placed on the other side of the roadway directly opposite the first set of stripes to mitigate the parallax effect seen while viewing traffic lanes from the roadside. *Note: Stakes were used for this purpose during field testing (see the parallax effect shown in Figure 4.1); Pavement marking tape would have eased analysis.*



Figure 4.1: Field Test, Distance Marking Stakes (40-foot spacing on both sides)

Record video of the traffic and capture the detected speeds of individual vehicles. Conventional cameras made for television playback in the United States record

approximately 30 frames per second. Some digital cameras can record 60 frames per second which provides a more accurate speed measurement.

After video recording a vehicle and noting its detected speed, calculate the actual vehicle speed based on how many frames of video were recorded as the vehicle passed between the two stripes. To aid in determining when the vehicle crosses each line, place a fine line of tape on the video playback screen across the road from stripe-to-stripe, one line for each of the two stripe mark sets. Extend a line from the two white stripes across the road if stripes were not placed on the opposite side of the road.

Determine the actual vehicle speed by the number of frames it takes the vehicle to move from stripe to stripe. Frame fractions can be estimated as fraction of distance moved relative to the stripe from one frame to the next if no frame shows the vehicle front at the stripe. An example formula is provided for a camera that records 30 frames per second.

$$V_{actual} = \frac{(100ft)}{\left(\frac{1 \text{ seconds}}{30 \text{ frames}}\right) * (\text{nuber of frames})}$$

4. Speed Estimation

Estimate vehicle speed from one or more of several inputs including:

- Speed limit
- Average speed of multiple measurement of vehicle speeds using a radar or laser gun
- Stop watch to measure travel times between two points of a known distance

A combination of these methods will improve the estimate. This method relies on operator experience and can produce adequate results if the operator makes appropriate estimates.

5. Vehicle Length Estimation

Once the loop spacing is set to produce reasonable vehicle speeds, the operator adjusts the loop length so that the reported length of a typical auto is 14 to 15 feet with approximately an equal number of typical autos being measured longer and shorter than 14 feet to 15 feet. This method depends on the vehicle mix, but requires relatively little personnel time to generate reasonable results. However, this method is not verifiable.

4.6 Rules of Thumb for Detector Calibration

Calibration Parameters. Depending on the detector, calibration can be done more precisely when loop spacing, loop length and detection threshold (also known as sensitivity) can be set individually for each lane. It is recommended that the detect threshold be set at a level of $1/16$ to $1/32$ of the inductance change caused by a typical auto. This will allow most motorcycles to be detected and will prevent dropping of detection at the center of semi-trailers and the center of trucks. This must be done prior to a calibration run.

Setting the Detect/Drop Threshold. To avoid double counting trucks, most counter/classifiers have a detection “drop threshold” that is a small fraction of the detect threshold. The drop threshold must be less than $1/32$ of the inductance change caused by a typical auto. If the drop threshold is set too small, the channel will be subject to stuck calls, particularly if the pavement is in poor condition or if the loop picks up extraneous noise.

Prevent Double Counting. As an alternative to using a detection/drop threshold very close to the “no vehicle present” operating condition, detectors may implement an algorithm that prevents double counting of trucks. This algorithm is frequently implemented as a timer that starts when the detection drops and prevents an additional detection that would begin before the timer expires which prevents double counting a single vehicle. Where applicable, the timer should be set as long as possible—generally about 0.25 seconds. This is used to prevent double counting trucks when the drop threshold is greater than the amount of inductance change at the center of the trailer/truck bed. Generally, the inductance change at the center of a truck is between $1/8$ and $1/16$ of the inductance change caused by a typical auto. Very few vehicles tailgate at less than a 0.3 second spacing and 0.25 seconds will prevent double-counting of most trucks down to 40 mph.

Chapter 5: Field and Laboratory Tests

This study conducted an extensive field evaluation of loop detectors. This section presents the test methodology and results. The testing process followed the Test Plan prepared for this project. This section covers testing of both loop detectors and non-loop detectors. All detectors were field tested. Only the loop detectors were laboratory tested.

5.1 Test Methodology

This section covers the field and laboratory test methodologies. Briefly summarized, the speed and length data obtained from the detectors was evaluated against the baseline. The test parameters were speed and length accuracy. Testing was conducted at free flow speeds. The length baseline primarily consisted of measurements of high-resolution video screenshots. This method was ground-truthed to an average absolute error of 0.43 feet. The speed accuracy was evaluated using piezoelectric sensors or a multi-detector correspondence algorithm (i.e. the baseline is the average recorded speed by multiple sensors within a predetermined tolerance).

5.1.1 Detectors Tested

The following criteria were used to determine which detectors were considered for testing. Additional detectors were tested that do not meet these criteria, but offer alternative classification capabilities.

1. Detectors must be commercially available.
2. The detector must be able to measure vehicles by length. The ability to report the length of individual vehicles is advantageous, but not necessary.
3. The loop-based detectors must be compatible with standard 6-foot by 6-foot (6'x6') square loops.

In addition, the project's Technical Advisory Committee (TAC) provided input on which detectors they were interested in testing. The detectors shown in Table 5.1 were requested to be tested in the June 2010 Kickoff Meeting and selected for testing upon additional discussion with the TAC. These products are commonly used by the pooled fund member states in continuous detection stations or there is interest in using these products.

Table 5.1: Detectors Tested

Loop Detectors	
Manufacturer	Model
Diamond	Phoenix I
Diamond	Phoenix II
GTT	Canoga C944
IRD	TCC-540
IRD	TRS
PEEK	ADR 3000

Table 5.1: Detectors Tested (cont.)

Non-Loop Detectors	
Manufacturer	Model
GTT	Canoga Microloops (C944 Card)
Vaisala/Nu-Metrics	Hi-Star NC200 ION
Vaisala/Nu-Metrics	Hi-Star NC300
Wavetronix	SmartSensor HD

Inductive Signature Detectors	
Manufacturer	Model
Diamond	iLoop
IST	IST-222
PEEK	ADR 6000

The TAC also desired to test other non-loop sensors; the Sensys Networks 240-F and ISS RTMS G4. However, the vendors declined to participate.

5.1.2 Field Test Description

Testing was conducted at two test sites to accommodate the loop and non-loop detectors. Due to their availability at the NIT test site on I-394 in Minneapolis, the GTT Canoga Microloops and Wavetronix HD sensors were tested at that site. Due to its portability, the Nu-Metrics Hi-Star detectors were tested at both sites.

When possible, the sensors were calibrated before any formal data collection activities began. Vendor guidelines were followed and sensor performance was monitored during the calibration process.

Three inductive signature-based loop detectors will be tested. These detectors use alternative means to perform length measurement. For example, the PEEK ADR 6000 detects axles to do axle-based classification. The IST and Diamond iLoop products use an inductive vehicle signature match to a lookup table. Because these capabilities are not directly comparable to the length classification, these methods will be independently evaluated.

The speed and length data obtained from the detectors was evaluated against the baseline. The test parameters were speed and length accuracy. Testing was conducted at free flow speeds.

5.1.3 Laboratory Test Description

The laboratory tests were run using a loop simulator. This device produces signals that simulate various sizes and speeds of vehicles. The following test parameters were evaluated.

- Determine detector scan rate. Determine if scan rate patterns emerge, such as alternating scan times.
- Determine unique features of loop detector equipment and the structure of electronics. For example, how many arrays can be simultaneously activated? What sensitivity adjustments can be made?

- Measure scan rate and determine scanning patterns at default, minimum, midpoint and maximum sensitivity settings.
- Test with various numbers of channels “activated.” Test with one loop, two loops, four loops, eight loops (if supported).
- Evaluate default sensitivity/hysteresis at 140μH and 580μH.
- Record percent inductance change for detect and drop values. For example, a detector may detect at a 0.2 percent inductance change and drop the call at 0.1 percent inductance change.
- Verify measurement accuracy by comparing theoretical test vehicle to detector data.
- Check operating inductance range (min/max).
- Test measurement consistency with default values for three test vehicles.

Thirty-five different vehicles were used for the laboratory tests. Waveforms for each of these vehicles were collected at the I-35 test site. Photos of each of these vehicles with their lengths and speeds are provided in Appendix A.

1. Motorcycle	4. SUV	8. Semi
2. Auto	4.1 Suburban	8.1 Tractor only
2.1 Compact	4.2 Full size	8.2 Bottom Dump Tank
2.2 Typical	4.3 Midsize	8.3 Tank
2.3 Full size	5. Motorhome	8.4 Short Flat Bed plus Flat Bed Trailer
2.4 Specialty	5.1 Small Motorhome	8.5 Long Flat Bed (empty)
2.4.1 Corvette	6. Bus	8.6 Container – Heavy Duty
2.4.2 Mini Cooper	6.1 Cross country passenger	8.7 Low Boy flatbed
2.4.3 VW Beetle	6.2 School Bus	8.8 Low Boy Flatbed #2
3. Pickup	7. Truck	8.9 Refrigeration Trailer
3.1 Full Size	7.1 Fire Truck	
3.2 Small	7.2 Concrete Mixer	
3.3 Specialty	7.3 Van – low box	
3.3.1 Pulling moving trailer	7.4 Van – high box	
3.3.2 Full size pulling large camper	7.5 Flat bed pulling changeable message sign	
	7.6 Bucket truck (large)	

- For each vehicle, determine:
 - Minimum/Maximum measurement length and percent error
 - Calculated minimum/maximum measurement length
 - Minimum/Maximum detected speed

5.1.4 Baseline Description and Ground-Truthing

The speed accuracy was evaluated using piezoelectric sensors or a multi-detector correspondence algorithm (i.e. the baseline is the average recorded speed by multiple sensors within a predetermined tolerance).

Baseline Length

The primary source of baseline vehicle length was a video capture and measurement method. High-definition still frames of each vehicle were captured and the vehicle length was determined using an imaging program.

Length Ground Truth – Video Method

The high-resolution video baseline method was ground-truthed by driving three vehicles of different known lengths through the test area: a passenger vehicle, a class 6 dump truck and a class 9 lowboy semi-truck. Images from the probe vehicle runs are shown in Figure 5.1. Each of these vehicles was measured with a tape measure in the field. Note that the dump truck has extensions off the front and back; in this case, the total vehicle length was measured, including these extensions.



Figure 5.1: Ground Truth Probe Vehicles

Only two passes of each vehicle were made due to inclement weather. Multiple measurements were made of these two passes by independently measuring different video screenshots. A plot of the ground truth versus the video measurement is shown. Note that the passenger vehicle and class 9 lowboy have tighter clustering in part because of their well-defined front and rear bumpers. A table of ground truth results and a scatter plot of the runs is shown in Table 2 and Figure 5.2.

Table 5.2: Video Method Ground Truth Results

Vehicle	Number of Measurements	Average Absolute Error (feet)	Average Absolute Percent Error
Passenger Vehicle	11	0.20	1.3%
Class 6 Dump Truck	10	0.81	3.0%
Class 9 Truck with Lowboy Trailer	6	0.22	2.1%
Weighted Average	27	0.43	2.1%

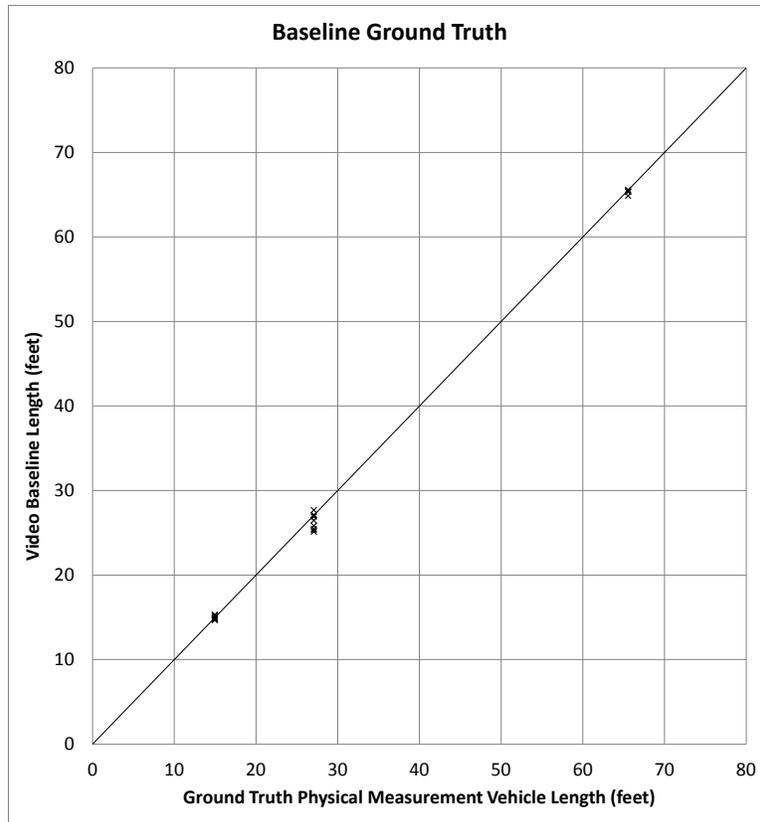

Figure 5.2: Ground Truth Probe Vehicles Scatter Plot

Baseline Speed

The baseline for the speed was determined based on the equipment available at the test sites. At the NIT test site, data from a piezo-based classification station was used. This site was calibrated by driving a probe vehicle travelling at a known speed was driven through the sites. At the I-35 test site, a correspondence algorithm was used to determine the baseline speed by averaging the speeds from multiple detectors that fell within a tolerance of one standard deviation.

At the Watertown, South Dakota site where the PEEK ADR 6000 was tested, speed was determined from the recorded high-definition video by measuring distance and time from frame by frame video captures (distance vehicle traveled divided by the time between video frames).

5.1.5 Loop Detector Installation

Based on input from the TAC, it was decided that the field tests would focus on “typical” loop detector installations. To this end, the test loops have the following characteristics:

- 6’x6’ square loops
- 2-1/2” to 2-3/4” depth
- Four wire turns
- Twisted lead-in (meet minimum twists per foot)
- Adjacent loops at least six feet away to minimize cross-talk
- 16’ loop spacing

The TAC also recommended that the following alternate loop shapes be tested:

- 6'x8' rectangular loops (8' dimension is perpendicular to the direction of travel)
- Quadrupole loops
- "Blade" loops (2.6' x full lane width)

Upon reviewing the loop installation specifications sent by several states, it was found that MnDOT's special provisions address most items that were requested by the TAC. The loops were installed in accordance with MnDOT standards (included in Appendix B).

The layout in Figure 5.3 shows where the loops were installed at the I-35 test site near the city of Wyoming, Minnesota. Each of these loop shapes was installed in a speed trap configuration with loops spaced at 16 feet (leading edge to leading edge).

Splices were made at each of the four handholes and lead in cable were run back to the handhole near the traffic cabinet. The maximum run was not more than 300 feet.

5.1.6 Non-Loop Detector Installation

The non-loop detectors each have different installation methods, although generally have much fewer installation steps than the loop detectors. The manufacturer's recommended installation procedures were used. For example, the Hi-Star detectors were taped to the center of the lane with mastic tape. The Wavetronix HD was mounted at a distance of 30 feet from the first lane and a height of 30 feet. Both of these detectors offer an automatic calibration method. The microloops were installed in a previous project, but their operation was checked by GTT and found to be in good working order.

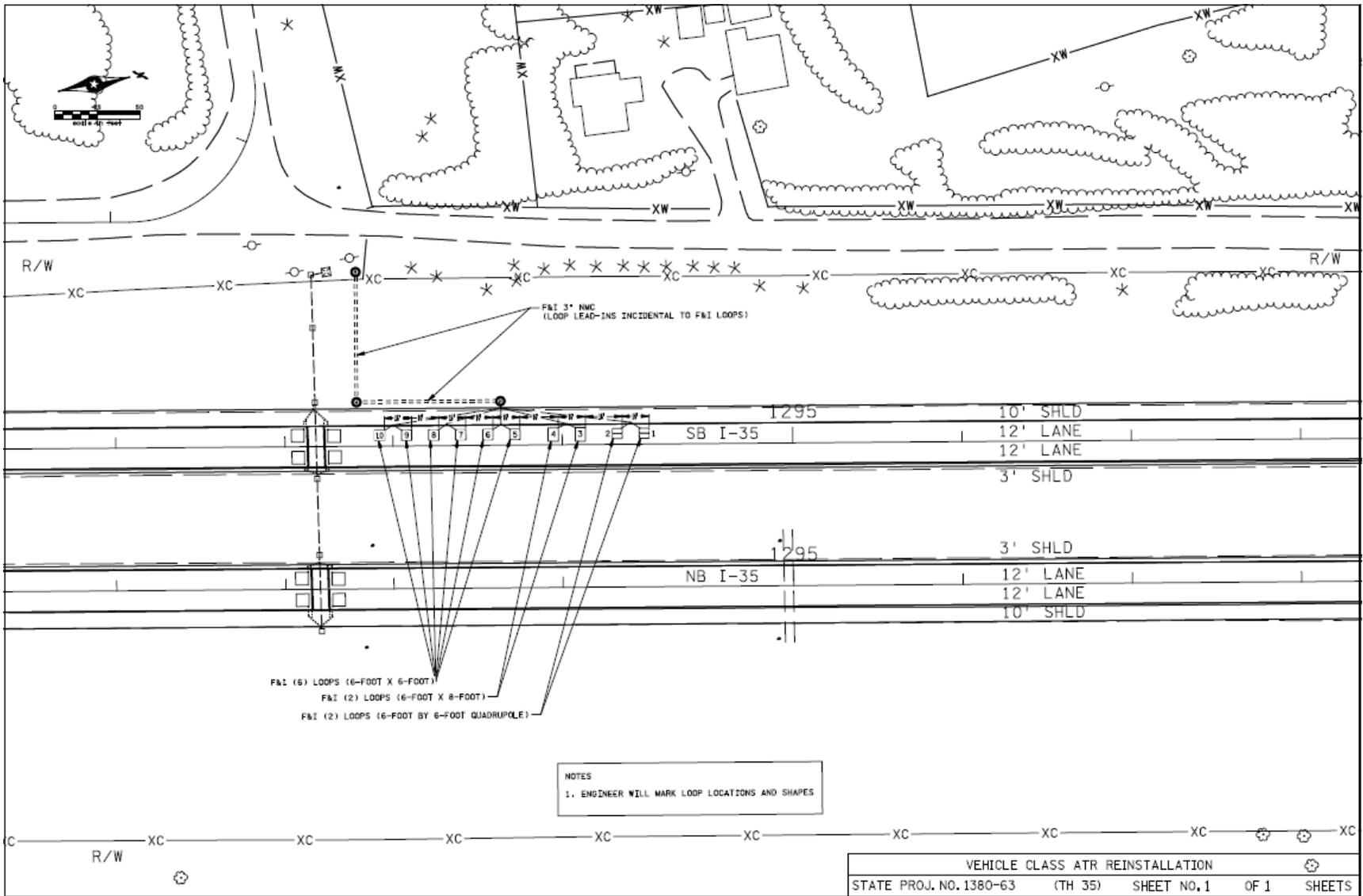

Figure 5.3: I-35 Test Site Loop Layout

5.2 Field Test Results

This section presents results for the field tests, including length accuracy, loop shape, lead-in distance and speed accuracy. Finally, a summary of false detections and missed vehicles is reported.

The data presented in this section should be considered a “best case” scenario. The detectors were calibrated immediately before data collection. The loop detectors were installed under careful inspection and precise measurement.

5.2.1 Length Accuracy

In order to minimize the effect of balancing errors (positive and negative errors balancing each other), the absolute value of each per vehicle record (PVR) was taken. The numbers presented in Table 5.4 show the AAE.

Detector length accuracy was determined by comparing per vehicle records from each of the detectors to the high-definition video baseline. The length AAE for 6’x6’ loops with short lead-ins ranged from 1.24 to 1.98 feet across all vehicles. The GTT Canoga had the highest AAE, but this detector only reports data to the full foot (not tenths of a foot like most other detectors), so includes additional error. Graphs of the loop data are shown in the next section that focuses on the comparison of the accuracy of the detectors when connected to 6’x6’ and 6’x8’ loops.

Table 5.3: Loop Detector Length Accuracy – Normal Length (200’-300’) Lead-In (Average Absolute Error)

Manufacturer	Model	6’x6’ loops (feet)	6’x8’ loops (feet)	Quadrupoles (feet)
Diamond	Phoenix I	1.24	1.79	3.5
Diamond	Phoenix II	1.74	1.09	4.0
GTT	Canoga C944	1.98	1.85	3.4
IRD	TCC-540	1.31	1.42	3.9
IRD	TRS	1.64	1.44	Did Not Function
PEEK	ADR 3000	1.34	2.05	3.8

Note: The IRD TRS was not tested with all loop shape pairs because it does not have the capability to automatically record per vehicle records. Per vehicle records can only be displayed to its Road Reporter software. This limited the ability to capture records. Also, the TRS was not able to detect vehicles when connected to the quadrupole loops. It is theorized that this is because the inductance change was not great enough for that detector to detect.

Results from the long lead in test compared the short lead-in results to the long lead-in results with a single detector is also shown in Table 5.5. Because the data was not compared to a true independent baseline, systematic errors the detector made on both loop pairs are repeated and would result in lower error.

Table 5.4: Loop Detector Length Accuracy – Long (1,500 Feet) Lead-In (Average Absolute Error)

Manufacturer	Model	Average Absolute Length Error (feet)
Diamond	Phoenix I	0.97
Diamond	Phoenix II	1.18
GTT	Canoga C944	1.41
IRD	TCC-540	1.51
IRD	TRS	Not Tested
PEEK	ADR 3000	1.80

The non-loop sensors were tested at the NIT Test Site. Additional testing of the Hi-Star sensors was conducted at the I-35 test site because those sensors require minimal setup and integration time. Table 5.6 shows the length AAE for the non-loop detectors.

Table 5.5: Non-Loop Detector Length Accuracy (Average Absolute Error)

Manufacturer	Model	Average Absolute Length Error (feet)
GTT	Canoga Microloops with C944 Card	5.81
Vaisala/Nu-Metrics	Hi-Star NC200 ION	2.65
Vaisala/Nu-Metrics	Hi-Star NC300	3.87
Wavetronix	SmartSensor HD	2.49

Additionally, inductive signature-based loop detectors were tested for their length measurement performance. These detectors were tested late in the field testing process after it was known that the 6’x8’ loops did not produce any measurable difference compared to the 6’x6’ loops and the quadrupole loops functioned worse with all detectors. Table 5.7 shows the length accuracy for the inductive signature detectors.

Table 5.6: Inductive-Signature-Based Loop Detector Length Accuracy

Manufacturer/Model	Loop Configuration Tested	Average Absolute Error (feet)
Diamond iLoop	6’x6’ Loops	1.61
IST IST-222	6’x6’ Loops	1.32
PEEK ADR 6000	6’x6’/Quadrupole Combination	1.36

Each of these detectors specializes in a particular function that is not necessarily related to length detection performance. In particular, the Diamond iLoop is designed to be able to identify vehicles’ inductive signatures and then match the signature with known vehicle lengths. The PEEK ADR 6000 was designed to detect axle spacings and report axle-based classification. However, some of these detectors also feature more sophisticated electronics that offer higher scan rates that may offer higher resolution data.

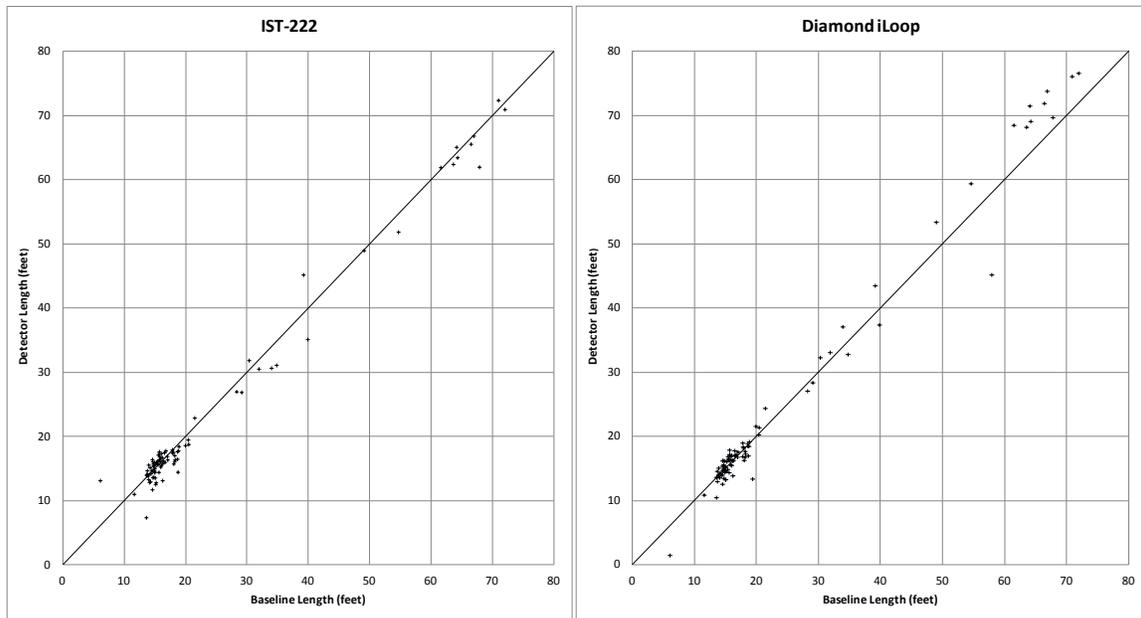

Figure 5.4: Inductive Signature Detector Length Accuracy

5.2.2 Loop Shape

It was found that loop shape for rectangular loops (6’x6’ versus 6’x8’) had a negligible impact on detection accuracy. The graphs shown in Figures 5.5(a), 5.5(b) and 5.5(c) illustrate the similarity in the data. Because 6’x8’ loops offer comparable length detection accuracy to 6’x6’ loops, the improved motorcycle detection may offer improved detector performance. The field data did not contain enough motorcycles to quantify the benefit of using 6’x8’ loops over 6’x6’ loops for motorcycle detection.

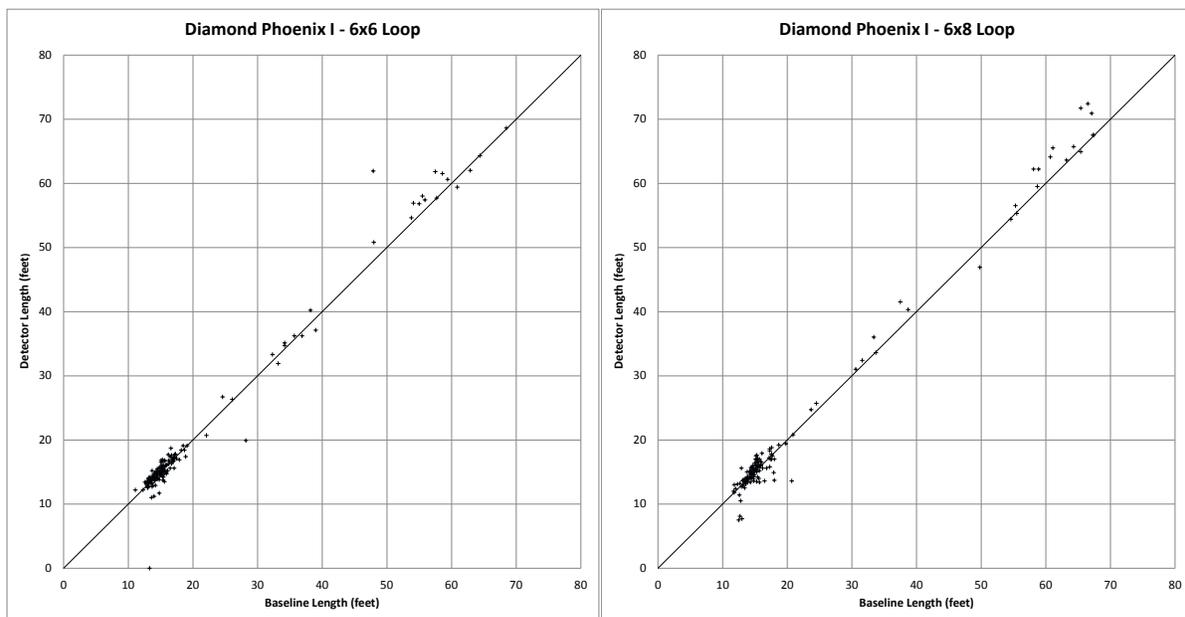

Figure 5.5(a): Length Accuracy for 6’x6’ vs. 6’x8’ Loops

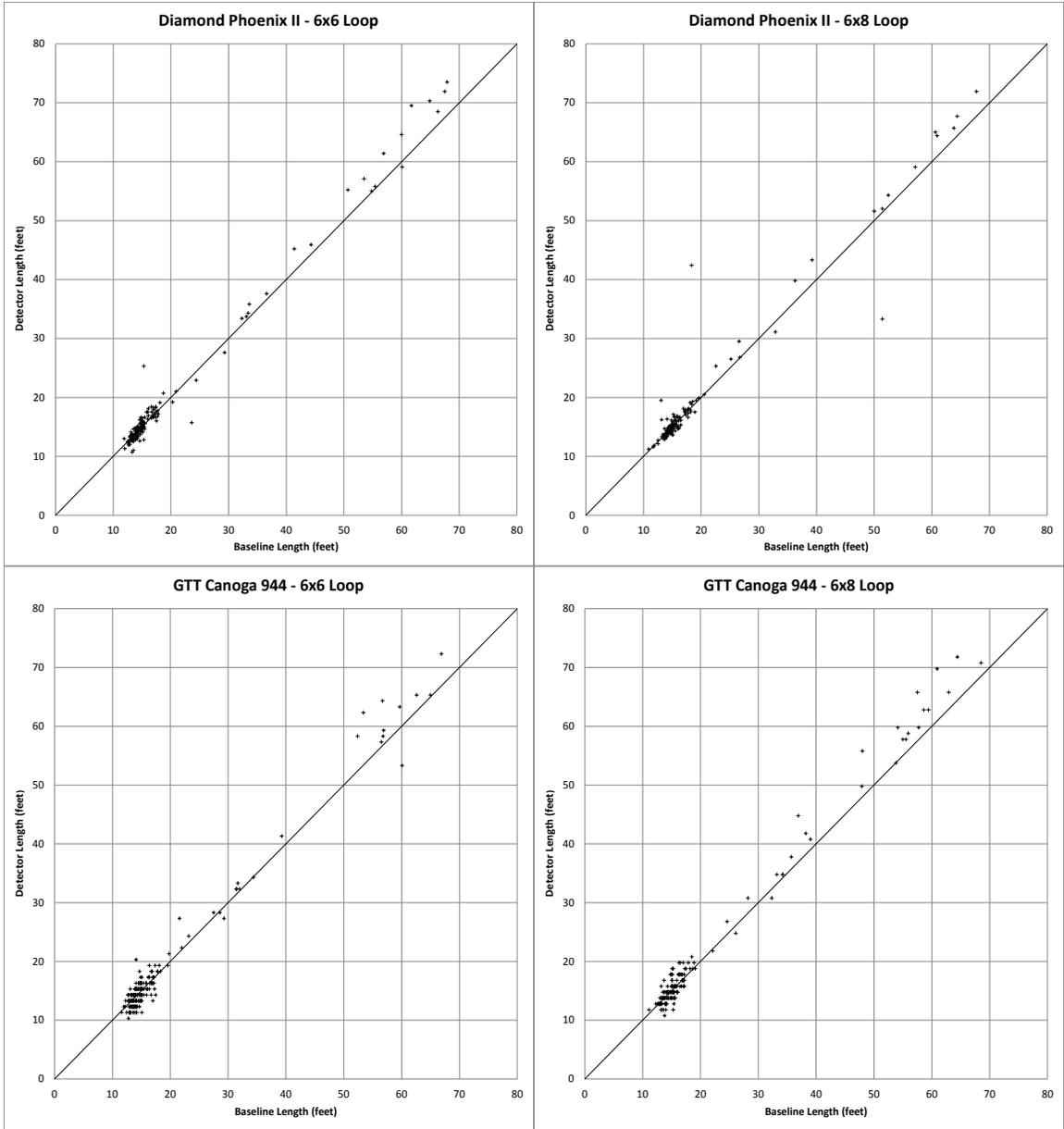

Figure 5.5(b): Length Accuracy for 6'x6' vs. 6'x8' Loops

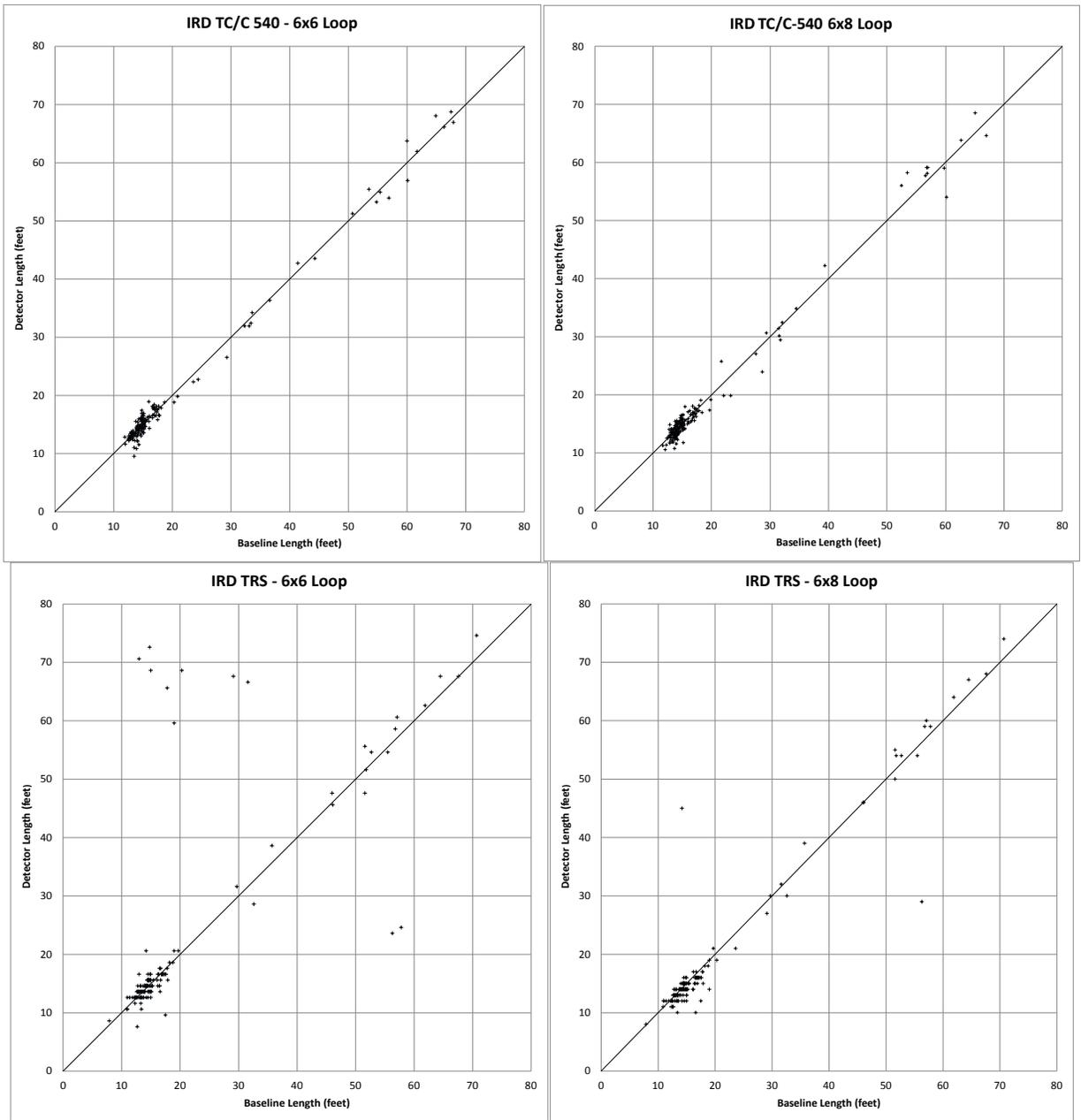

Figure 5.5(c): Length Accuracy for 6'x6' vs. 6'x8' Loops

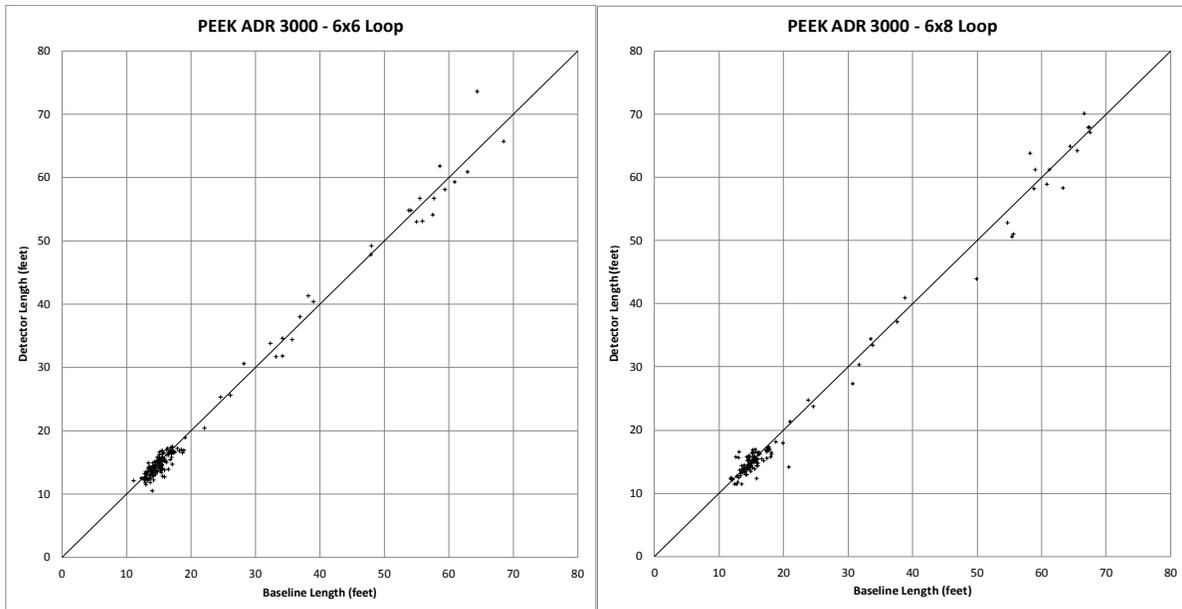

Figure 5.5(d): Length Accuracy for 6’x6’ vs. 6’x8’ Loops

Quadrupole (6’x6’) loops were also tested with the expectation that they might offer improved motorcycle detection. Unfortunately, testing was conducted in the fall when few motorcycles were on the road. However, another problem with the quadrupole loops emerged. It was found that these loops required the sensitivity to be set higher to detect trucks. The magnetic field of the 6’x6’ quadrupole loop is much smaller than a square loop. Thus quadrupole loops are more likely to drop a call with high-bed trucks.

The “Blade” loop produced a similar finding as the quadrupole although it was exacerbated for traditional loop detectors. The Blade loops that were installed at the MnROAD were quadrupoles that were 2.6-feet long and the entire lane width wide as shown in Figure 5.6. The magnetic field for the Blade loop is even smaller than a 6’x6’ quadrupole and sensitivity settings would need to be set far beyond their normal limits to generate detections.

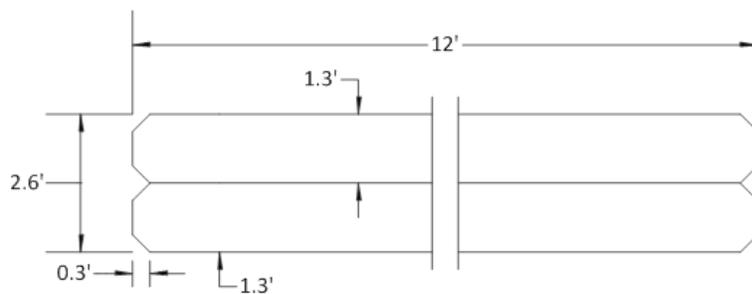

Figure 5.6: Blade Loop Sawcut Detail

5.2.3 Lead-In Distance

While a majority of the loop detector testing was done with 200 to 300-foot lead-ins, the traditional loop detectors were also tested with 1,500-foot lead-ins. Pre-twisted lead-in cable was

used and it was found that there is no significant difference with detection with long or short lead-ins. However, longer lead-in runs increase exposure to additional electro-magnetic interference which is known to degrade performance.

Examples of the long lead-in results for the PEEK ADR 3000 and Diamond Phoenix II are shown in Figure 5.7. These tests were run while the detectors were connected to both a short lead-in loop pair and long lead-in loop pair. The AAE of the long lead-in compared to the short lead-in was found to be 1.80 feet and 1.73 feet respectively.

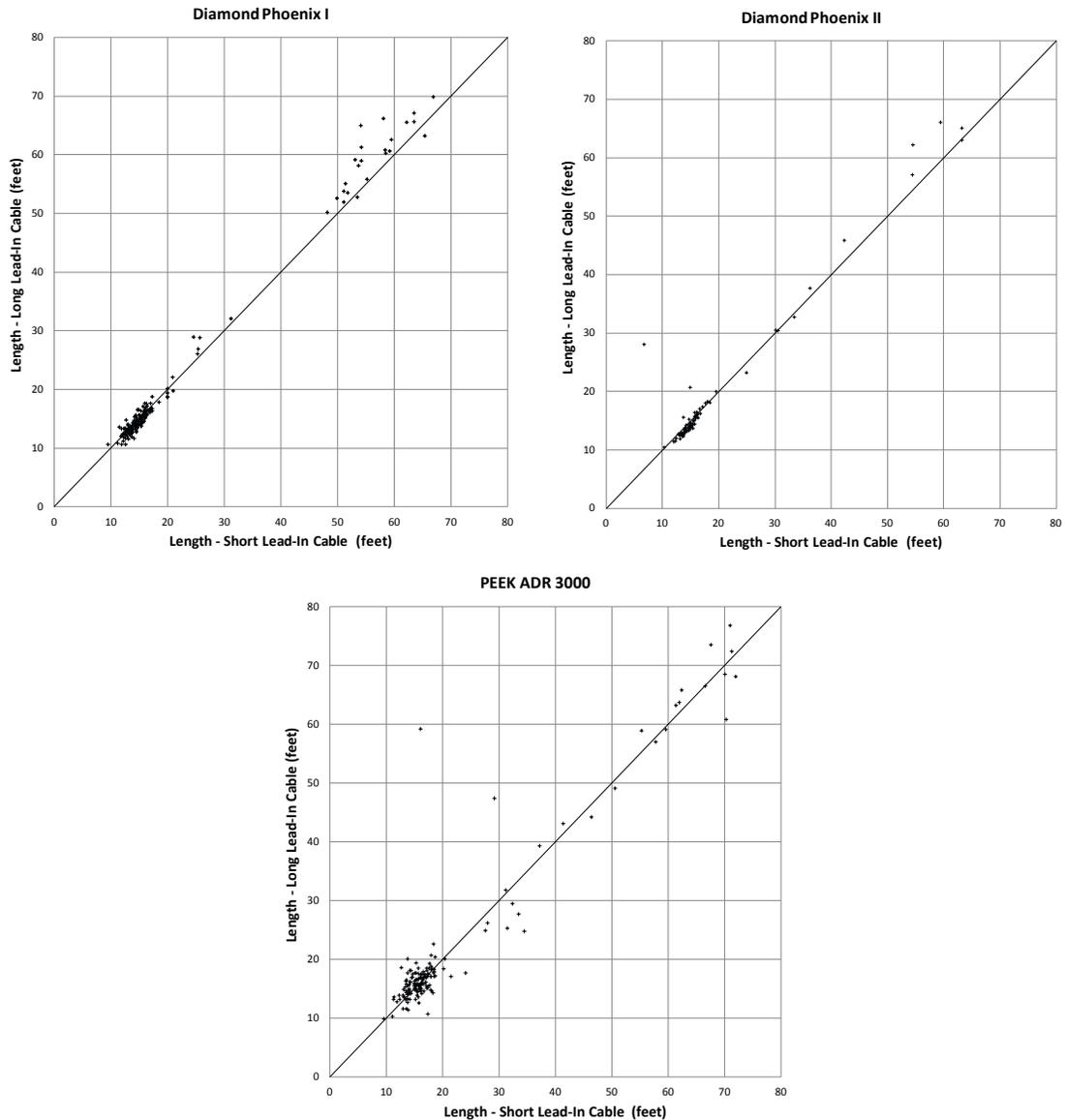

Figure 5.7: Sample Long Lead-In Test Results

5.2.4 Speed Accuracy

As with the length accuracy analysis, the primary method for analyzing speed data was to compare per vehicle speed records against a baseline. As described in the Section 4.1, conventional loop detector theory uses speed as an input to calculate length. Therefore, it is not surprising that the AAE distributions for speed and length are similar. The length AAE for conventional loop detectors is provided in Table 5.8. Supporting graphs that show the range and distribution of these speed detections is shown in Figures 5.8(a) and 5.8(b).

Table 5.7: Loop Detector Speed Absolute Average Error

Manufacturer/Model	Error (mph)
Diamond Phoenix I	1.67
Diamond Phoenix II	1.74
GTT Canoga C944	2.14
IRD TCC-540	1.81
IRD TRS	1.82
PEEK ADR 3000	5.33

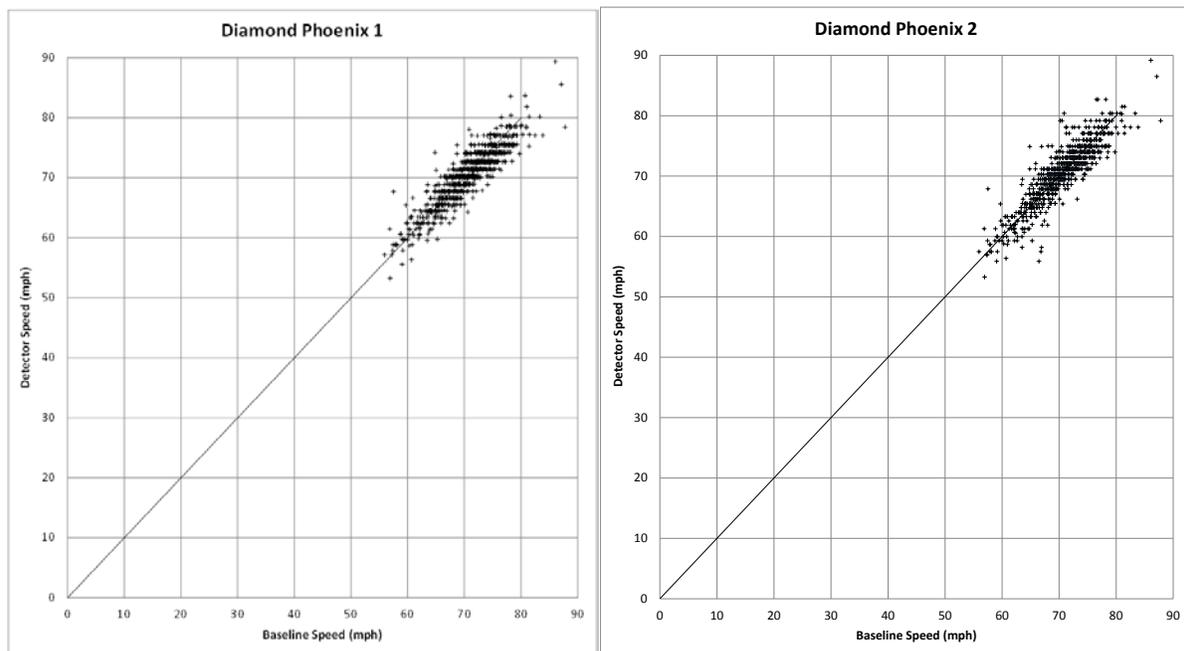

Figure 5.8(a): Loop Detector Speed Accuracy

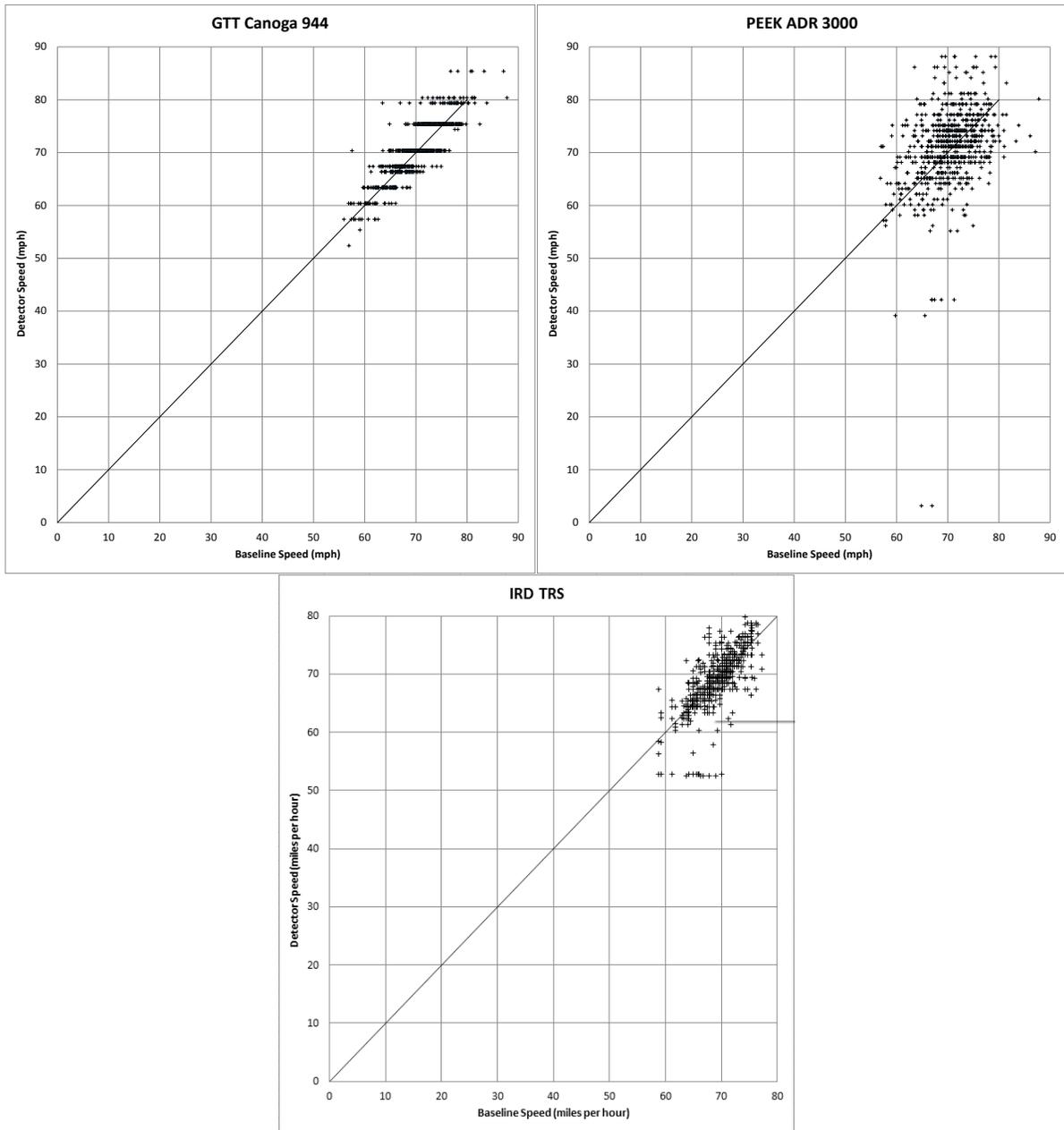

Figure 5.8(b): Loop Detector Speed Accuracy

Non-loop detectors were tested similarly to the loop detectors and reported speed AAE in the same range as loop detectors. The speed data for non-loop detectors are reported in Figure 5.9 and Table 5.9.

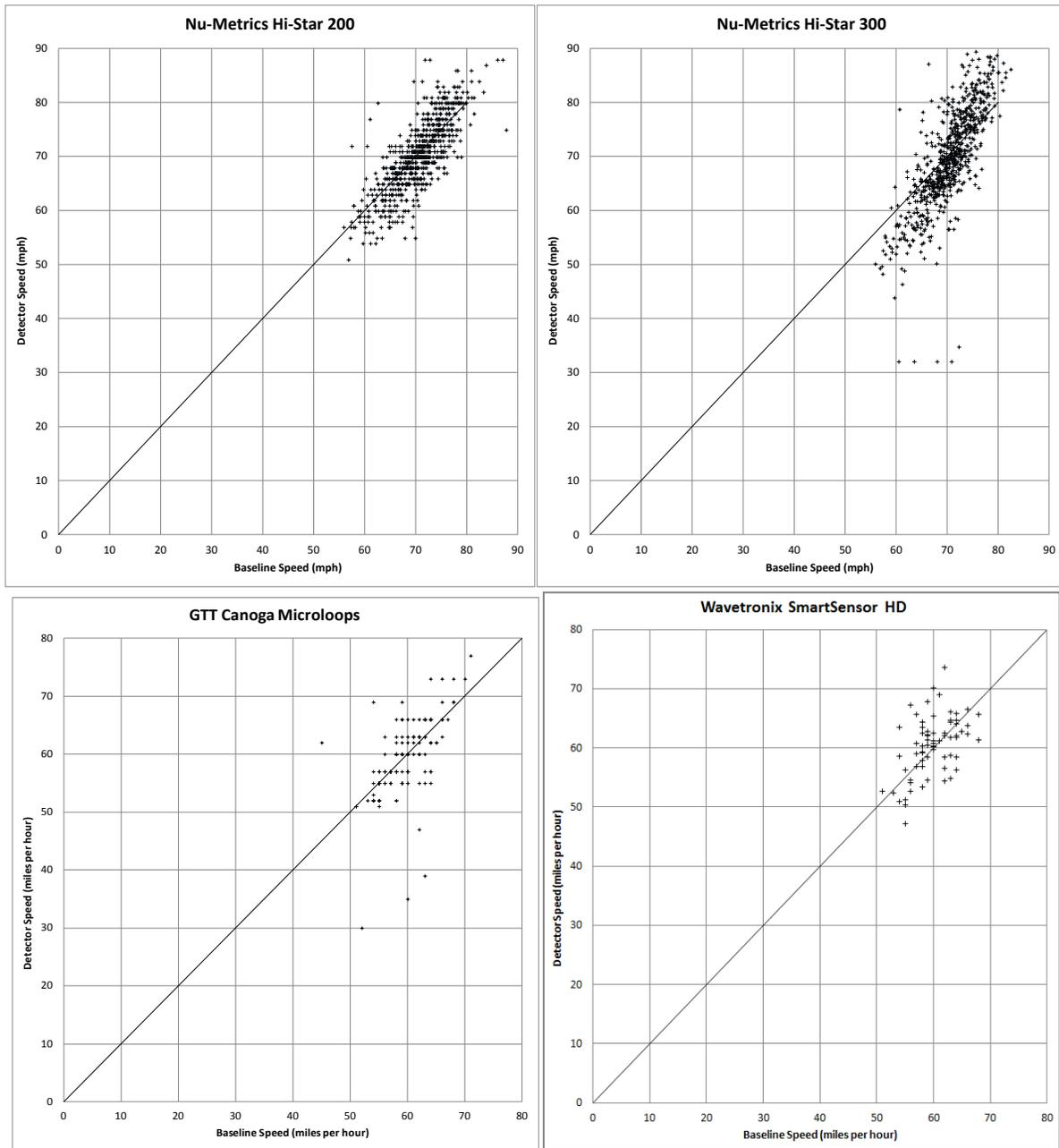

Figure 5.9: Non-Loop Detector Speed Accuracy

Table 5.8: Non-Loop Detector – Absolute Average Speed Error

Manufacturer	Model	Average Absolute Error (mph)
GTT	Canoga Microloops and C944 Card	2.52
Vaisala/Nu-Metrics	Hi-Star NC200	7.37
Vaisala/Nu-Metrics	Hi-Star NC300	5.50
Wavetronix	SmartSensor HD	3.43

While raw speed accuracy findings are a good way to compare detector accuracy, most speed data collection is done with speed bins. When vehicle speeds are binned, small errors may not be discernible. The data presented in Tables 5.10 and 5.11 show a representation of the data binned to 5 mph increments. Each number in the table represents the count of vehicles that were detected at the corresponding speed by both the baseline and subject detector. The gray shaded areas show perfect correlation between the baseline and detector.

Table 5.9: Loop Detector Speed Bin Matrices

Diamond Phoenix I

		Baseline Speed Bin				
		<65	65-70	70-75	75-80	>80
Detector Speed Bin	<65	83	19	1	0	0
	65-70	19	149	36	0	0
	70-75	1	74	237	51	0
	75-80	0	1	27	66	9
	>80	0	0	0	3	6

IRD TRS

		Baseline Speed Bin				
		<65	65-70	70-75	75-80	>80
Detector Speed Bin	<65	49	40	3	0	0
	65-70	21	155	44	4	0
	70-75	2	45	160	6	0
	75-80	0	11	27	20	0
	>80	0	0	2	4	0

Diamond Phoenix II

		Baseline Speed Bin				
		<65	65-70	70-75	75-80	>80
Detector Speed Bin	<65	83	30	0	0	0
	65-70	19	142	37	0	0
	70-75	2	71	237	58	0
	75-80	0	0	23	56	7
	>80	0	0	2	7	8

PEEK ADR 3000

		Baseline Speed Bin				
		<65	65-70	70-75	75-80	>80
Detector Speed Bin	<65	40	35	20	1	0
	65-70	28	84	68	19	1
	70-75	17	70	113	42	6
	75-80	12	27	55	33	3
	>80	2	16	25	23	5

GTT Canoga 944 (Loops)

		Baseline Speed Bin				
		<65	65-70	70-75	75-80	>80
Detector Speed Bin	<65	73	23	0	0	0
	65-70	22	100	12	0	0
	70-75	7	109	141	9	0
	75-80	2	11	143	102	5
	>80	0	0	5	10	10

Table 5.10: Non-Loop Detector Speed Bin Matrices

GTT Canoga 944 (Microloops)

		Baseline Speed Bin				
		<55	55-60	60-65	65-70	>70
Detector Speed Bin	<55	101	55	26	0	0
	55-60	15	82	16	0	0
	60-65	5	123	104	5	0
	65-70	5	24	58	32	0
	>70	0	0	5	16	5

Nu-Metrics Hi-Star 300

		Baseline Speed Bin				
		<65	65-70	70-75	75-80	>80
Detector Speed Bin	<65	85	102	22	2	0
	65-70	10	88	69	4	0
	70-75	2	21	92	12	0
	75-80	1	7	70	35	1
	>80	0	4	26	62	13

Nu-Metrics Hi-Star 200

		Baseline Speed Bin				
		<65	65-70	70-75	75-80	>80
Detector Speed Bin	<65	83	62	14	0	0
	65-70	14	132	87	10	0
	70-75	4	38	135	36	1
	75-80	2	1	49	47	2
	>80	0	1	12	26	12

Wavetronix Smartsensor HD

		Baseline Speed Bin				
		<55	55-60	60-65	65-70	>70
Detector Speed Bin	<55	57	50	18	0	0
	55-60	19	78	49	0	0
	60-65	10	137	114	29	0
	65-70	0	37	28	18	0
	>70	0	10	10	0	0

5.2.5 False Detections and Missed Vehicles

While this testing focused on length and speed detection accuracy, the findings above only include data that matched the baseline on a per-vehicle basis. Throughout data analysis, most detectors missed vehicles or overcounted vehicles. Tables 5.12 and 5.13 account for these errors. Rather than incorporating this data into the main accuracy metrics where it would have significant effects on the results, these detection errors are segregated here. For example, a single vehicle that was detected as having a length of zero feet can have a major effect on the accuracy and standard deviations. The primary error for missed vehicles is due to lane changes or when the detector does not drop the call after a large truck. Overcounted vehicle detections happen most often when trucks are broken into two detection events.

The data was recorded at the I-35 and NIT test sites with an approximately equal number of vehicles in each sample size (700+). However, the data for the PEEK ADR 6000 was taken at a South Dakota DOT ATR near Watertown, South Dakota. That site had low traffic volumes (150 vehicles recorded in one hour in the subject lane) and infrequent lane changing which are factors in the detector’s accurate count result.

Sensitivity was adjusted during the loop detector calibration process to minimize these errors, but the non-uniform nature of live traffic creates a challenging environment for loop detectors and it is generally accepted that some of these errors are inevitable.

Table 5.11: Loop Detector Count Errors

Model	Missed Vehicles	Overcounted Vehicles
Diamond Phoenix I/IRD TCC-540	0.1%	1.0%
Diamond Phoenix II	2.2%	0.0%
GTT Canoga 944 (Loop)	0.2%	1.1%
PEEK ADR 3000	0.3%	0.9%
PEEK ADR 6000	0.0%	0.0%
IRD TRS	0.9%	1.4%

Table 5.12: Non-Loop Detector Count Errors

Model	Missed Vehicles	Overcounted Vehicles
GTT Canoga Microloops	0.0%	2.3%
Hi-Star NC-200 ION	1.5%	0.4%
Hi-Star NC-300	3.3%	0.5%
Wavetronix Smartsensor HD	2.3%	1.6%

5.3 Laboratory Test Results

In order to generate “apples to apples” results and compare technical aspects of the loop detectors, a series of laboratory tests was conducted using a loop simulator. This allows for the direct comparison of the same inductance waveforms “played back” on each of the loop detectors. It is difficult to perform this type of analysis with field tests because it is not possible to collect data from multiple loop detectors connected to the same loop. As a vehicle passes over a series of loops, its speed or lateral positioning can change. Also, despite careful installation, small inconsistencies can lead to differences in the loop’s magnetic field.

The inductance waveforms were collected by recording vehicles travelling at freeway speeds over loops at the I-35 test site. These vehicles were video recorded to determine their length and speed. Where possible, exact vehicle models were identified and manufacturer-published physical lengths were used for baseline lengths.

The vehicles that were selected for this analysis were chosen because they represented a wide variety of vehicle types and combinations. The laboratory tests used 35 test vehicle waveforms to test the six subject loop detectors. Figure 5.10 illustrates the wide distribution of vehicle lengths tested. Photos and waveform plots of each of these vehicles are shown in Appendix A.

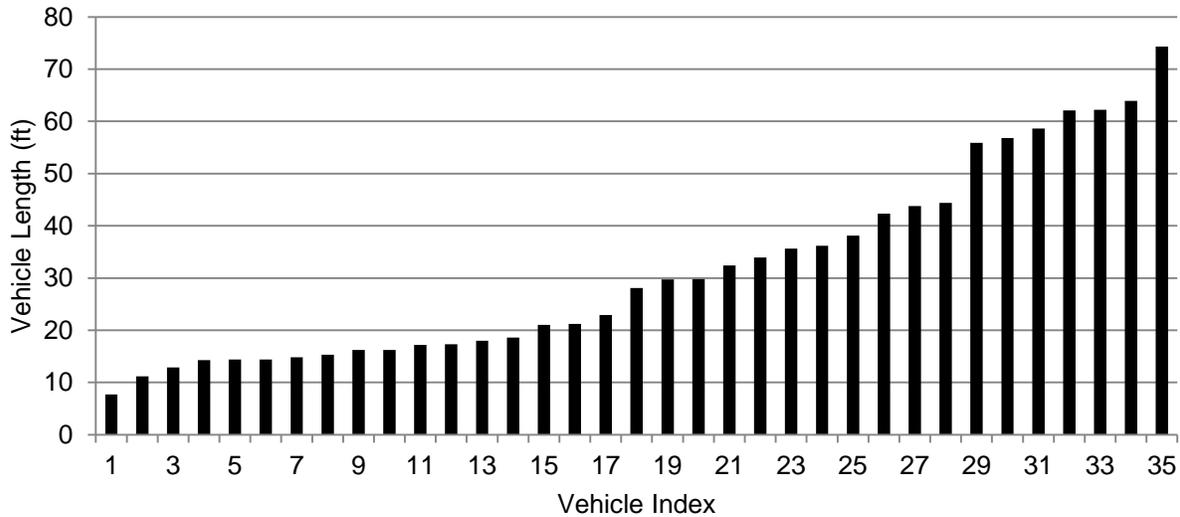

Figure 5.10: Length Distribution of Laboratory Test Vehicle

All 35 vehicles were tested under a single condition for a short period (70 mph, average of 65 observations per vehicle), yielding a total of 234 test cases. The simulation consisted of playing back a recorded inductance waveform to reproduce the loop input at a specific preset speed. The simulation sought to simulate a rural, four-lane interstate like the I-35 field test site, so at any given time the classifier monitored four simulated lanes. Additionally, for each detector model, an automobile and semi-trailer combination vehicle were tested under extended periods (over 1,000 observations) at two different speeds (40 mph and 70 mph).

For a given classifier, vehicles were tested in pairs with one vehicle per lane in each direction. The identical vehicle passages were played back repeatedly as if the same vehicle passed over the detector at exactly the same speed. Therefore, in the absence of errors, the classifier response should be identical for all of the passages of a given vehicle. However, small errors are expected due to the discrete time steps used to measure speed and detect duration. The per-vehicle measured speed and vehicle length were recorded for each passage. After many simulated passes, a new pair of vehicle signatures were tested. This process was repeated until all 35 test cases were run on the classifier.

5.3.1 Short Duration Tests – 35 Vehicle Test Cases

For the short observation period at 70 mph for all 35 vehicles, each vehicle was tested in two lanes. Due to the relatively small sample size, the two lanes with a given vehicle have been combined for analysis. The smallest sample size was 25 and largest was 144 observations.

The speed detection of all of the classifiers gave consistent results across the 35 vehicles. Figure 5.11 averages the results by axle class and shows that all of the sensors had a speed AAE below 2 mph for the 70 mph vehicles. Among these, the Phoenix I had the lowest AAE at 0.6 mph and the TRS the highest at 1.6 mph.

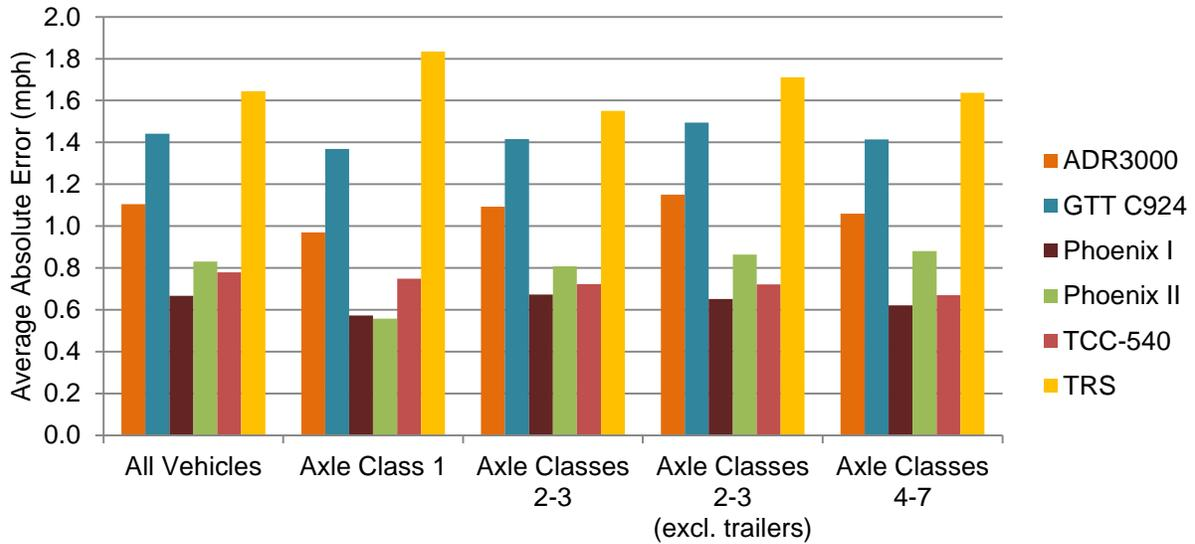

Figure 5.11: Short Duration Test – Avg. Absolute Speed Error by Classification Grouping

Performance varied from vehicle to vehicle for the AAE in length, as shown in Figure 5.12 (the vehicles are sorted by length, which are shown for reference in Figure 5.10). The TRS classifier showed markedly worse performance than the other classifiers, with roughly twice the AAE and much larger variability across the vehicles.

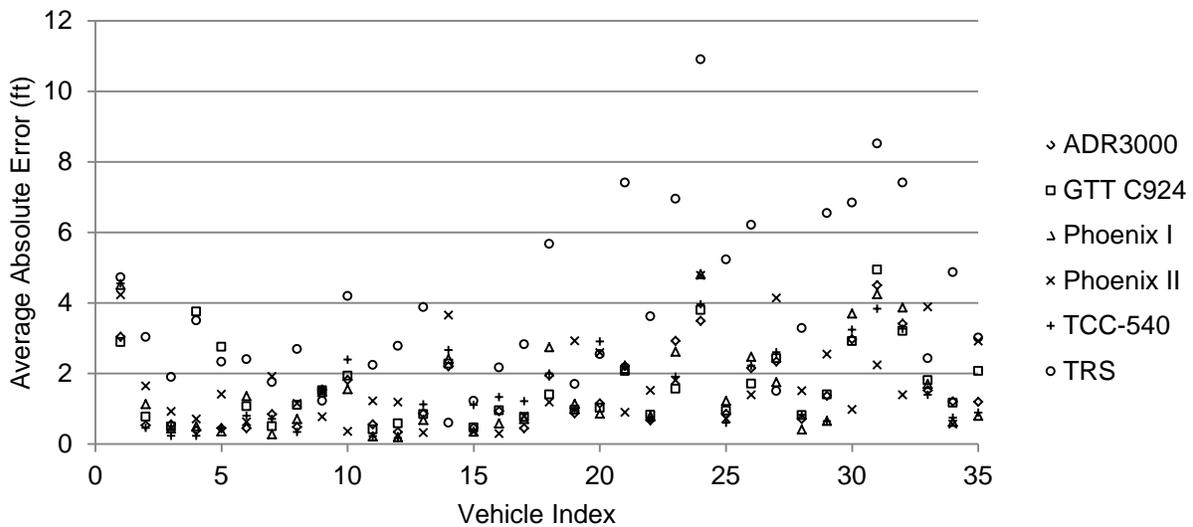

Figure 5.12: Short Duration Test – Per-Vehicle Average Absolute Error

Figure 5.13 clusters the vehicles by axle class and shows the AAE in inches to facilitate comparison. This figure shows that all of the classifiers except TRS exhibited the worst performance on the motorcycle, then multi-unit trucks, then single-unit trucks, and finally passenger vehicles.

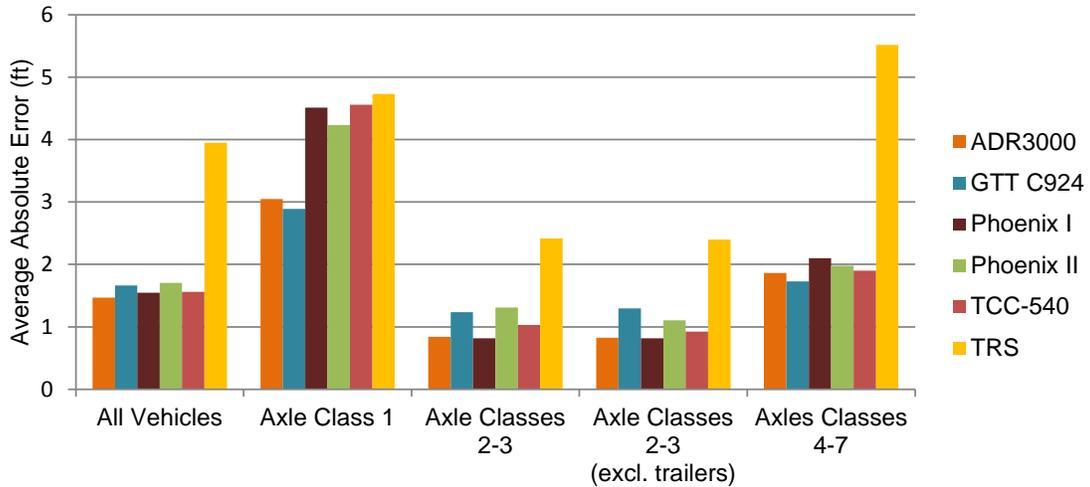

Figure 5.13: Average Absolute Error – Clustered by Axle Classification Grouping

This general trend remains when the vehicles are clustered by length rather axle class, as shown in Figure 5.14.

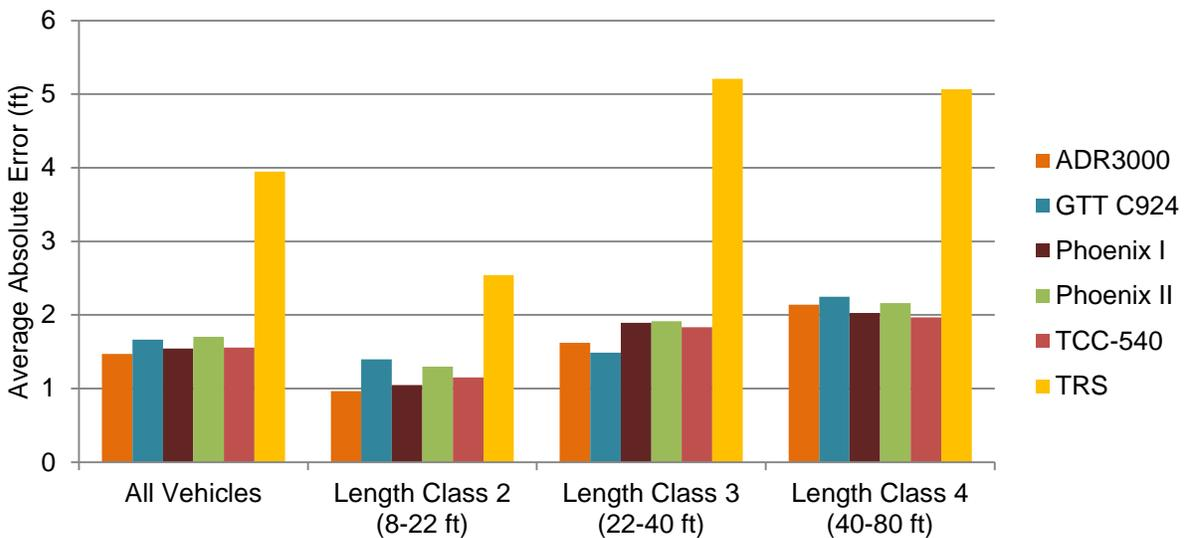

Figure 5.14: Average Absolute Error – Clustered by Vehicle Length Grouping

5.3.2 Long-Duration Test – Automobile and Semi-Truck at 40 and 70 MPH

For the long duration observation periods, the speed accuracy results are similar for the 70 mph tests, but drop roughly in half for most of the classifiers in the 40 mph case, as shown in Figure 5.15.

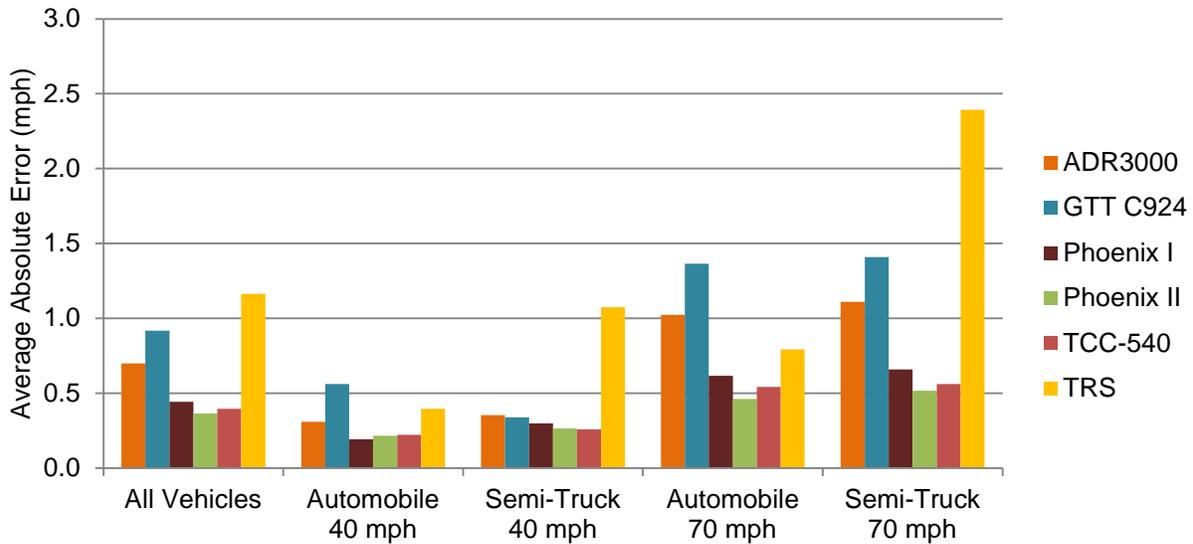

Figure 5.15: Long-Duration Test – Average Absolute Speed Error by Test Case

The improved speed measurements at the lower speed should not be surprising because one should expect an error on the order of one sample period due to discretization. Also, since the vehicles take roughly twice as long to traverse the dual loop detectors at 40 mph, the impact of a single sample period is proportionally smaller. For the two vehicles chosen, speed is the dominant factor determining the AAE of length as shown in Figure 5.16. Here too, the Phoenix I had the lowest AAE at 0.59 feet and the TRS had the highest at 1.18 feet. The TRS data is not shown on the graph because it skews the graph due to a large error on trucks caused by the detector not dropping the detection call after the truck departed the loop.

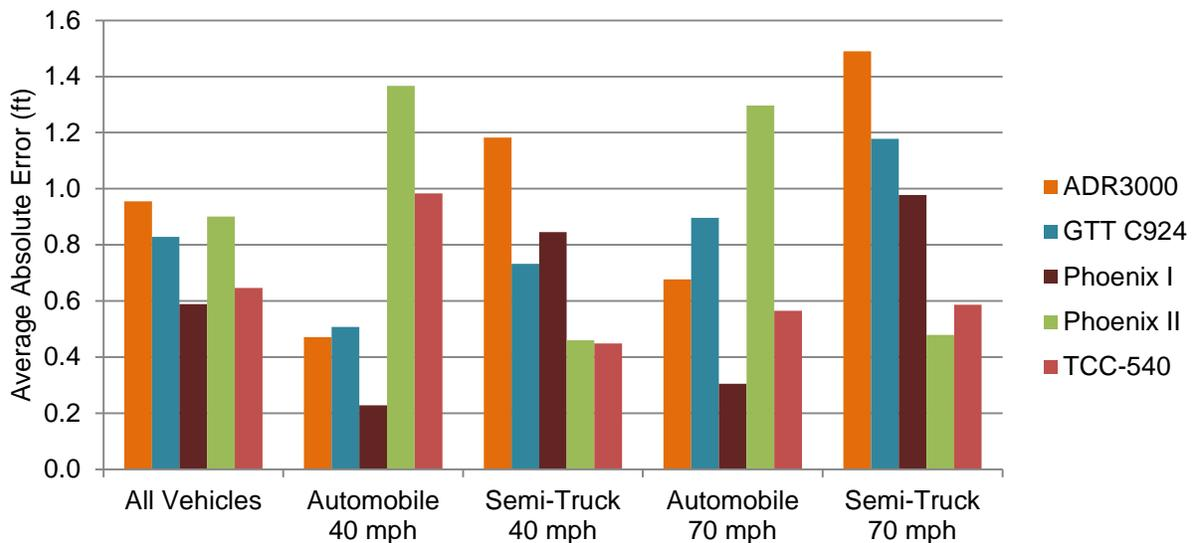

Figure 5.16: Long-Duration Test – Average Absolute Length Error by Test Case

Chapter 6: Conclusions

This project studies many aspects of LBVC in an effort to develop a length-based scheme for classifying vehicles and consider practical implications of using this type of classification.

Two LBVC schemes are recommended with varying thresholds based on whether the site is in a rural or urbanized area. The first has four classes and the second adds a class for regions with large combination vehicles. The length thresholds are:

- MC/S – 6.5 feet
- S/M – 21.5 feet (20 feet for urbanized areas)
- M/L – 49 feet (43 feet for urbanized areas)

An additional threshold could be added for states with LCV to be determined by the local agency.

This report recommends a method for calibrating length-based detectors and gives accuracy criteria for validating the calibrated site. The primary recommendation is to use a physically-measured passenger automobile as a probe vehicle. Alternative methods for calibration are presented for use when it is not possible to perform a calibration with probe vehicles. Additionally, this report details some theoretical and practical considerations for calibrating loop detectors. These schemes will be validated by conducting testing at sites in multiple states that address various traffic patterns.

The field and laboratory tests quantified detector length and speed error. The testing found that despite different specifications, the detectors generally reported comparable length and speed data. A more significant source of error is the precision with which the detector reports data. Detectors that report to less than one foot precision produce lower per vehicle errors when data is aggregated.

Six by six-foot loops performed similarly to 6'x8' loops. Six by six-foot quadrupole loops performed poorly for vehicles with high beds due to their relatively small magnetic field. Loop performance was not found to be degraded when a "long" lead-in of 1,500 feet of twisted lead-in wire was used. Laboratory testing found generally small absolute errors which shows that loop detector data is generally repeatable. Based on these findings, preliminary results show that current practice of installing 6'x6' and 6'x8' loops should be continued. The benefit of installing 6'x8' loops is improved motorcycle detection at the lane edges. As with most field installation practices, a quality careful installation is important for obtaining good data.

References

- American Association of State Highway and Transportation Officials. (2008). *AASHTO guidelines for traffic data programs*. Washington, DC.
- Applied Research Associates. *LTPP weigh-in-motion field calibrations and validations*. Washington, DC: Federal Highway Administration.
- Cambridge Systematics, Inc. (2010). *Counting motorcycles* (NCHRP Project 8-36, Task 92). Washington, DC: National Cooperative Highway Research Program.
- Cheeverunothai, P., Wang, Y., & Nihan N. (2007). Using dual-loop event data to enhance truck data accuracy. *Proceedings of the Transportation Research Board Annual Meeting*.
- Chen, L., & May, A. D. (1987). Traffic detector errors and diagnostics. *Transportation Research Record, 1132*, 82–93.
- Cheung, S., Coleri, S., Dundar, B., Ganesh, S., Tan, C., & Varaiya, P. (2005). Traffic measurement and vehicle classification with single magnetic sensor. *Transportation Research Record, 1917*, 173–181.
- Cleghorn, D., Hall, F., & Garbuio, D. (1991). Improved data screening techniques for freeway traffic management systems. *Transportation Research Record, 1320*, 17–31.
- Coifman, B., & Dhoorjaty, S. (2004). Event data based traffic detector validation tests. *Journal of Transportation Engineering, 130*(3), 313–321.
- Coifman, B. (1999). Using dual loop speed traps to identify detector errors. *Transportation Research Record, 1683*, 47–58.
- Coifman, B. (2001). Improved velocity estimation using single loop detectors. *Transportation Research: Part A, 35*(10), 863–880.
- Coifman, B. (2006). Vehicle level evaluation of loop detectors and the remote traffic microwave sensor. *Journal of Transportation Engineering, 132*(3), 213–226.
- Federal Highway Administration. (1997). *FHWA study tour for European traffic monitoring programs and technologies*. FHWA's Scanning Program. Washington, DC.
- Federal Highway Administration. (2001). *Traffic monitoring guide*. Washington, DC.
- French, J., & French, M. (2006). *Traffic data collection methodologies*. Harrisburg, PA: Pennsylvania Department of Transportation.
- Gajda, J., Sroka, R., Stencel, M., Wajda, A., & Zeglen, T. (2001). A vehicle classification based on inductive loop detectors. *Proceedings of IEEE Instrumentation and Measurement Technology Conference*. Budapest, Hungary. May 21–23, 2001.

- Jacobson, L, Nihan, N., & Bender, J. (1990). Detecting erroneous loop detector data in a freeway traffic management system. *Transportation Research Record*, 1287, 151–166.
- Ki, Y., & Baik, D. (2006) Vehicle-classification algorithm for single-loop detectors using neural networks. *IEEE Transactions on Vehicular Technology*. 55(6), 1704–1711.
- Klein, L., Mills, M., & Gibson, D. (2006). *Traffic detector handbook: Third edition—Volume I*. McLean, VA: Federal Highway Administration.
- Nihan, N. (1997). Aid to determining freeway metering rates and detecting loop errors. *Journal of Transportation Engineering*, 123(6), 454–458.
- Oh, S., Oh, C., & Ritchie, S. (2002). Real-time traffic measurement from single loop inductive signatures. *Transportation Research Record*, 1804, 98–106.
- Reijmers, J. (1979). On-line vehicle classification. *Proceedings of the International Symposium on Traffic Control Systems*, 2B, 87–102. Institute of Transportation Studies. University of California at Berkeley.
- Sun, C., & Ritchie, S. (2000). Heuristic vehicle classification using inductive signatures on freeways. *Transportation Research Record*, 1717, 130–136.
- Tok, Y. C. A. (2008). *Commercial vehicle classification system using advanced inductive loop technology* (UCTC Dissertation No. 161). University of California Transportation Center.
- Vandervalk-Ostrander, A., Turner, S., Hallenbeck, M., & Wilkinson, J. (2009). *AASHTO guidelines for traffic data programs*. Washington, DC: American Society of State Highway and Transportation Officials.
- Washington State Transportation Center, & Applied Research Associates. (2010, June). *Verification, refinement and applicability of LTPP classification scheme* (Draft interim report prepared for LTPP). Olympia, WA: Washington State Transportation Center.
- Zhang, X., Nihan, N., & Wang, Y. (2005). Improved dual-loop detection system for collecting real-time truck data. *Transportation Research Record*, 1917, 108–115.
- Zwahlen, H. T., Russ, A., Oner, E. & Parthasarathy, M. (2005). Evaluation of microwave radar trailers for non-intrusive traffic measurements. *Transportation Research Record*, 1917, 127–140.

Appendix A: Loop Simulator Testing of Counter/Classifiers

1 Introduction

Measuring inherent equipment limitations is difficult in a field setting, where various factors complicate analysis. However, this can be accomplished in a laboratory setting by using a loop simulator. The GTT loop simulator was used for this study.

Using the loop simulator technology one can fully simulate field operating conditions while simultaneously having precise control of the stimulation seen by each loop detector channel. The variation in results then defines the accuracy capabilities, at least under relatively ideal conditions, of the counter/classifiers being tested. Some advantages of the loop simulator analysis are:

- a. Each system is calibrated in the same manner using the same vehicle waveform at the same speed.
- b. Waveforms played during performance testing are those of multiple vehicle types at two or more vehicle speeds.
- c. Loop inductance is set to the same value as at the field test site.
- d. Vehicle waveforms (inductance changes injected in series with the loop inductance) are those of actual vehicles passing over actual loops at the test site.
- e. Vehicle speed (time waveform starts at lead loop to time waveform starts at lag loop plus duration of waveform) is precisely controlled and the same at each loop for each vehicle passage.

Testing was done using a 4-lane configuration for each unit, a typical “rural freeway” configuration.

The speed and length measurements of each vehicle pass by each unit were recorded and analyzed for repeatability and variation over vehicle types and speeds.

1.1 Speed Measurement Accuracy

It is generally accepted that speed measurement variability for any specific piece of equipment is determined by:

Scan Time: Time in between inductance measurements on the same loop.

Noise: Variability in the detection threshold from one measurement to the next.

Noise can arise from many sources. The most common sources of noise are environmental noise (electrical and temperature), equipment variations from one moment to the next, and system mechanical problems that affect the effective loop inductance. While the loop simulator can generate noise, no noise will be generated in the loop simulator during this testing. Thus the noise being evaluated will be that of equipment variations from one moment to the next.

If tests show essentially the same accuracy at 40mph and 70mph, the primary error source is likely instability of detection threshold. If tests show error is proportional to speed, the error source is likely primarily scan time related. It is probable that most equipment will show errors from both causes.

1.2 Vehicle Length Measurement Accuracy

Vehicle length measurements inherently have a larger error base since speed measurement error compounds any error in the vehicle detection duration (the basis for length calculations).

Length measurement for each unit was calibrated using a waveform for a semi pulling a lowboy trailer. The basic ability to measure vehicle lengths was then checked by playing at waveforms from different vehicle types, at least 20 passes per vehicle type at 70 mph.

1.3 Test Procedure

Test conditions for loop simulation:

- a. Inductance = 160 microhenries, a typical value for a 6'X6' 4-turn loop with 175 feet of lead-in/home-run cable.
- b. Resistance = 2.8 Ω , about double that of the actual test loops, but still has $Q > 10$. Q is further explained in Section 2.1.

1.3.1 Calibrate Units for Speed and Length Measurement

The loop simulator played a set of waveforms: LBVCACal.set (AutoCmp.VL1 on Ch1, AutoCmpD.VL1 on Ch2, AutoTyC.VL1 on Ch3 and AutoTyCD.VL1 on Ch4). Images of the vehicle from each of these waveform sets is shown later in this appendix. The loop spacing was set to 16 feet. The loop length was adjusted to achieve measured vehicle lengths of about 15.1 feet for AutoCmp.VL1 and 14.2 feet for AutoTyC.VL1.

1.3.2 Basic Measurement Accuracy of Unit

The unit's basic measurement capability was checked by playing each vehicle type, auto and truck, on all four lanes, each vehicle moving at the same speed for 1,000 passes of that vehicle. An auto was played on Lane 1 and Lane 4, a semi was played on Lane 2 and Lane 3. All vehicles were first played at a speed of 70 mph for 1000 passes and then all vehicles were played at 40 mph for 1000 passes.

Table of Test Conditions for Basic Speed and Length Measurement Accuracy Tests (LBVCCK70.set)		
Lane	Vehicle	Speed
1	Auto (AutoCmp.VL1 – 15.1' Lg)	70
2	Semi (SwTnkT.VL1 – 63.9' Lg)	70
3	Semi (SwTnkT.VL1 – 63.9' Lg)	70
4	Auto (AutoCmp.VL1 – 15.1' Lg)	70
Each vehicle was played 1000 times, 4 seconds between vehicles (test duration 70 minutes long).		

Table of Test Conditions for Basic Speed and Length Measurement Accuracy Tests (LBVCCK40.set)		
Lane	Vehicle	Speed
1	Auto (AutoCmp.VL1 – 15.1' Lg)	40
2	Semi (SwTnkT.VL1 – 63.9' Lg)	40
3	Semi (SwTnkT.VL1 – 63.9' Lg)	40
4	Auto (AutoCmp.VL1 – 15.1' Lg)	40
Each vehicle was played 1000 times, 4 seconds between vehicles (test duration 70 minutes long).		

The accuracy results are presented in the body of the report in Section 5.3.

1.3.3 Vehicle Length Measurement Accuracy Over Different Vehicle Types

The basic ability to measure vehicle lengths was now checked by playing waveforms from different vehicle types, at least 20 passes per vehicle type at 70 mph. The waveform simulator can play 4 vehicle waveforms. Two waveforms per lane are required to simulate the vehicle traveling between the lead and lag loop. Thus two types of vehicles were played for each test of 20+ passes of the same vehicle. The waveforms to be used are listed below. These are the recorded waveforms from actual vehicles traveling over the 4-turn 6'X6' loops at the I-35 test site.

1.3.4 Waveforms

The waveforms were recorded from vehicles traveling at or near the 70 mph speed limit. The vehicle speed and vehicle length were estimated from 1080P HD video recordings of the vehicle passing over the loop pair. The loop simulator testing allows for measurement of a device's capability of repeatedly obtaining the same result for the same vehicle repeatedly passing at the same speed. It also allows comparison of the data obtained from each device to that obtained by the other devices, each device repeatedly seeing exactly the same waveform played at exactly the same speed. The waveforms are played every 4 seconds during each test. The *D.VL1 waveform is the *.VL1 waveform with its start delayed by the travel time for the speed played between the lead and lag loops.

The figures that follow provide the inductive waveform for a variety of vehicles that were used in this study. Where available, the manufacturer's published bumper-to-bumper length is shown as well as the video-measured length.

1.3.4.1 LBVC1.set

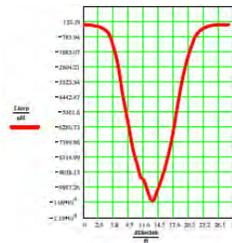

2010 Chevrolet Cruze

15.1' Bumper-to-Bumper Length, 14.4' Video-Measured Length

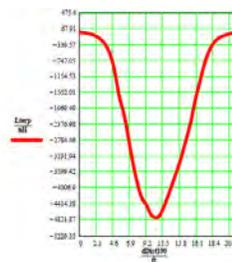

2008 Ford Escape Hybrid

14.6' Bumper-to-Bumper Length, 14.3' Video-Measured Length

1.3.4.2 LBVC2.set

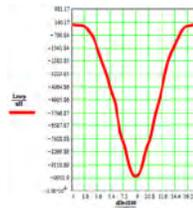

1997 Chevrolet Corvette

15.0' Bumper-to-Bumper Length, 14.4' Video-Measured Length

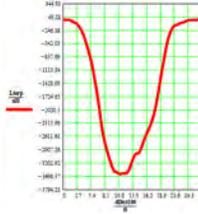

1995 Chevrolet Silverado
18.2' Bumper-to-Bumper Length, 18.0 Video-Measured Length

1.3.4.3 LBVC3.set

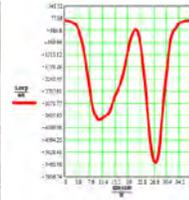

2005-06 Dodge Ram pulling UHaul
29.8' Video-Measured Length

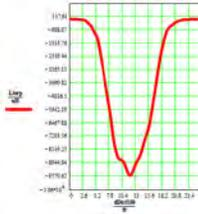

2002 Ford Windstar
16.8' Bumper-to-Bumper Length, 16.2' Video-Measured Length

1.3.4.4 LBVC4.set



Semi – Bottom Dump Tank
56.8' Video-Measured Length

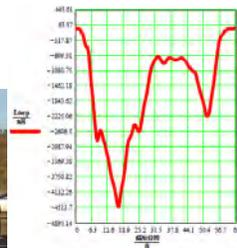

Semi – Tank Trailer
63.9' Video-Measured Length

1.3.4.5 LBVC5.set



Truck – Flat Bed w/Flt Bd TR
62.1' Video-Measured Length

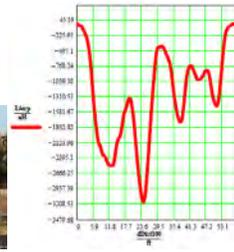

Semi – Flat Bed Trailer
58.6' Video-Measured Length

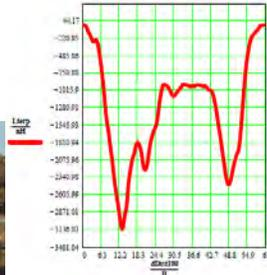

1.3.4.6 LBVC6.set



Van - Ford E350 18 Pass.
19.7' Bumper-to-Bumper Length, 18.6' Video-Measured Length

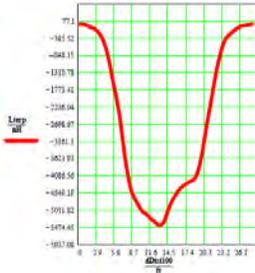

Van – Chev. Bus Hdcp
23.4' Bumper-to-Bumper Length, 21.0' Video-Measured Length



1.3.4.7 LBVC7.set

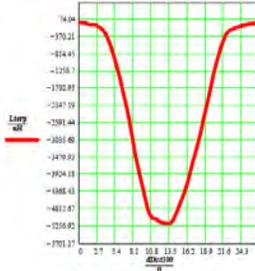

SUV – Full Size 2005-06 Tahoe
16.6' Bumper-to-Bumper Length, 16.2' Video-Measured Length

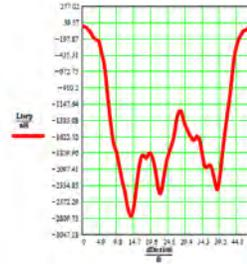

Semi – HD Container Tr.
42.3' Video-Measured Length

1.3.4.8 LBVC8.set

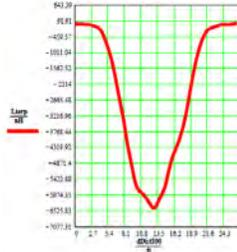

SUV – 2006 Suburban
18.3' Bumper-to-Bumper Length, 17.3'

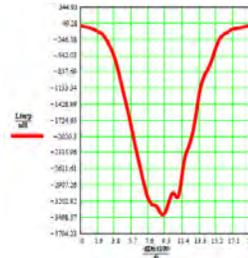

Auto – Subcmt 2007-09 Mini Cooper
12.1' Bumper-to-Bumper Length, 11.2' Video-Measured Length

1.3.4.9 LBVC9.set

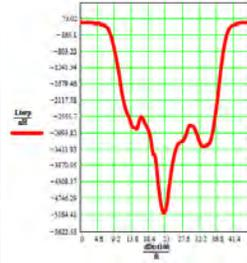

Fire Truck
33.9' Video-Measured Length

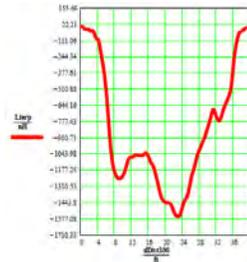

Truck - Concrete Mixer
36.2' Video-Measured Length

1.3.4.10 LBVC10.set

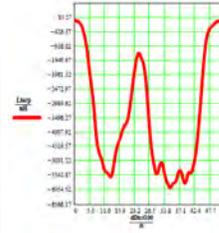

PU-2009 Ford F-150 w/Camper
44.4' Video-Measured Length

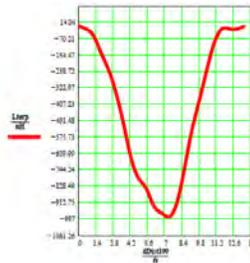

Motorcycle
7.7' Video-Measured Length

1.3.4.11 LBVC11.set

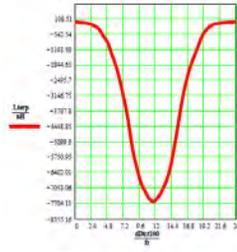

Auto – 2003-05 VW Beetle
13.4' Bumper-to-Bumper Length, 12.9' Video-Measured Length

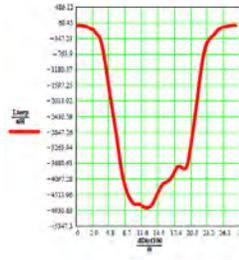

Motorhome – small
22.9' Bumper-to-Bumper Length, 21.2' Video-Measured Length

1.3.4.12 LBVC12.set

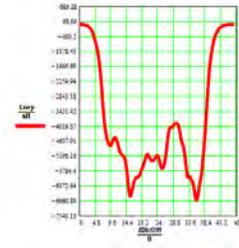

Bus – Cross Country pass.
43.8' Video-Measured Length BusCC.VL1 and BusCCD.VL1

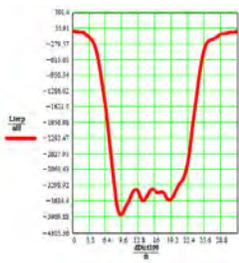

Truck – Ford E-350 Van (low)
22.9' Video-Measured Length

1.3.4.13 LBVC13.set

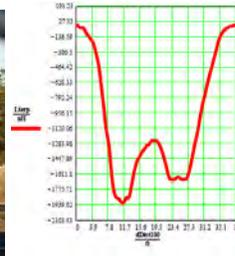

Truck – Freightliner Van (high)
32.4' Video-Measured Length



Semi – Volvo Tractor
28.1' Video-Measured Length

1.3.4.14 LBVC14.set

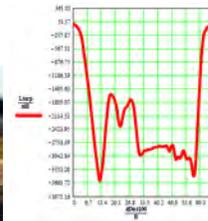

Semi – w Low Boy Flat Bed Tr
66.2' Video-Measured Length

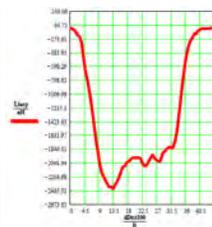

Bus – International School
38.1' Video-Measured Length

1.3.4.15 LBVC15.set



Semi – w Low Boy Flat Bed Tr.
74.3' Video-Measured Length

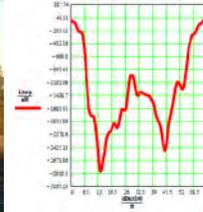

Semi – w Refrigeration Trailer
55.9' Video-Measured Length

1.3.4.16 LBVC16.set

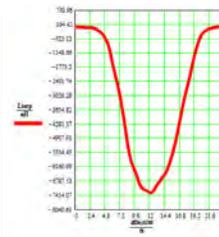

Auto – 2006 Ford Crown Victoria
17.7' Bumper-to-Bumper Length, 17.2' Video-Measured Length

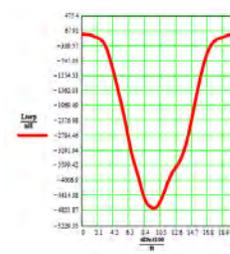

Pickup – 1994 Chev. S10
15.8' Bumper-to-Bumper Length, 15.3' Video-Measured Length

1.3.4.17 LBVC17.set

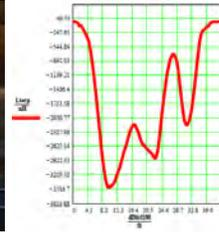

Truck – 2010-11 Ford F-350 Fl. Bed w CM Sign Tr.
29.7' Video-Measured Length

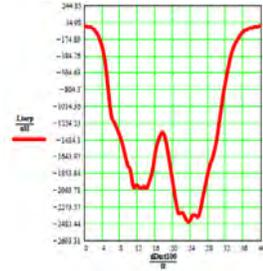

AK Truck – Bucket (large)
35.6' Video-Measured Length

1.3.4.18 LBVC18.set

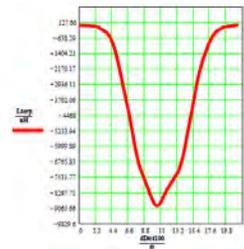

Auto – 1991 Toyota Corolla
14.2' Bumper-to-Bumper Length, 14.8' Video-Measured Length

Appendix B: MnDOT Loop Detector Standard Plates

MILL & OVERLAY CONSTRUCTION

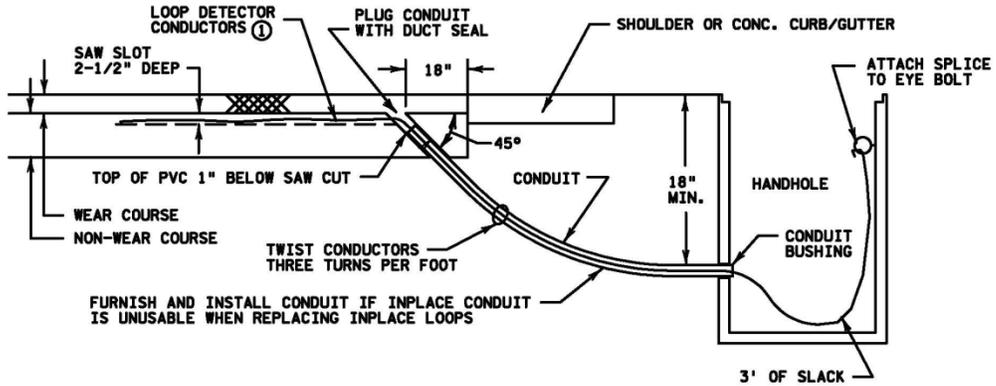

INPLACE ROADWAYS

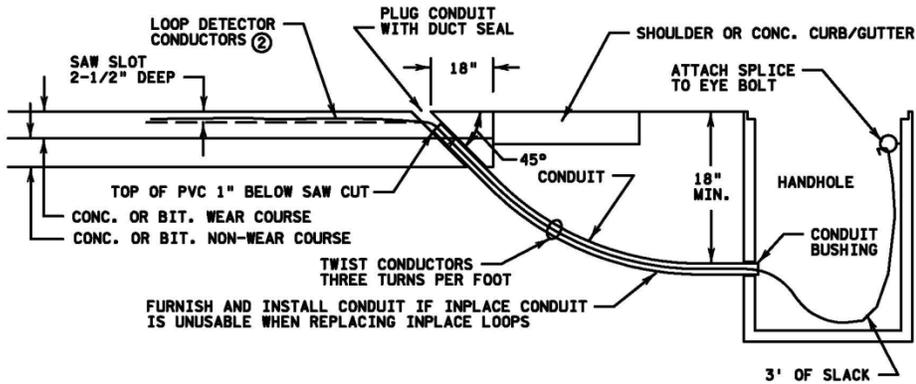

NOTES:

SEE SHEET 3 FOR ADDITIONAL NOTES

- ① SAW CUT LOOP DETECTOR BETWEEN NON-WEAR AND WEAR COURSES
- ② SAW CUT LOOP DETECTOR INTO WEAR COURSE OR CONC. SURFACE

APPROVED DECEMBER 11, 2009

Milakus
STATE DESIGN ENGINEER

STATE OF MINNESOTA
DEPARTMENT OF TRANSPORTATION
SAW CUT LOOP DETECTORS
LOOP/HANDHOLE INSTALLATION

SPECIFICATION
REFERENCE
2565

STANDARD
PLATE
NO.
8130E
1 OF 3

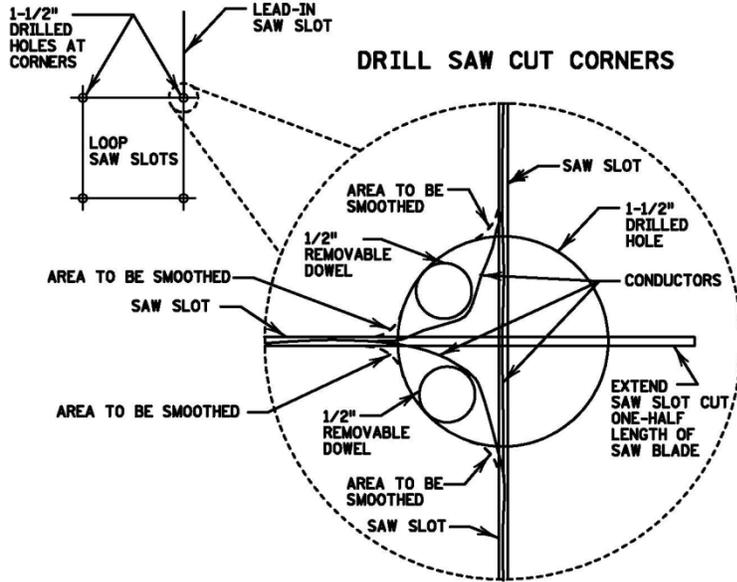

TYPICAL APPROACH DETECTORS ②

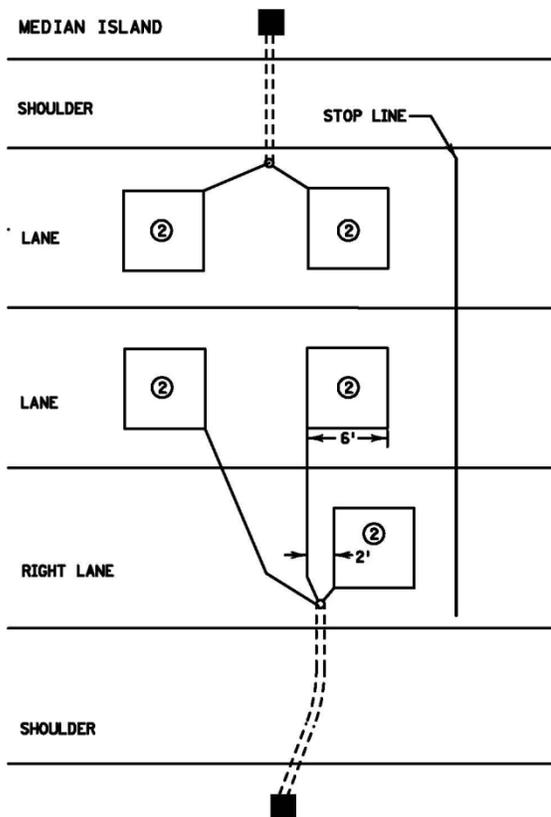

MULTIPLE LOOP SERIES HOOKUP

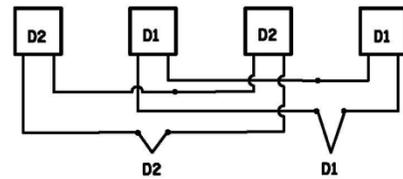

JOINT/CRACK INSTALLATION ①

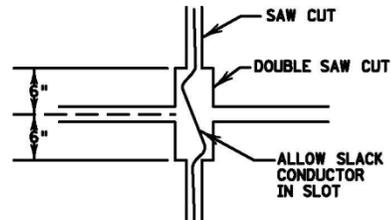

NOTES:

- SEE SHEET 3 FOR ADDITIONAL NOTES.
- ① LOOP LEADS SHALL NOT CROSS TRANSVERSE JOINTS IN CONCRETE PAVEMENT. MOVE A LOOP TO THE NEXT PANEL AND INSTALL A SEPARATE CONDUIT TO THE HANDHOLE IF ALL LOOPS WILL NOT FIT ONE PANEL AND MAINTAIN SEPARATIONS SHOWN.
- ② SEE PLAN LAYOUT FOR ACTUAL DETECTOR SIZE AND PLACEMENT LOCATION.

APPROVED DECEMBER 11, 2009

M. Rakus
STATE DESIGN ENGINEER

STATE OF MINNESOTA
DEPARTMENT OF TRANSPORTATION
SAW CUT LOOP DETECTORS
DETAILS

SPECIFICATION
REFERENCE
2565

STANDARD
PLATE
NO.
8130E
2 OF 3

NOTES:

1. WHERE LOOP DETECTORS ARE TO BE FURNISHED AND INSTALLED AND THE ROADWAYS ARE TO BE SURFACED WITH NEW BITUMINOUS PAVEMENT, THE LOOP DETECTORS SHALL BE SAW CUT IN THE ROADWAY AND SEALANT MATERIAL PLACED TO THE SATISFACTION OF THE ENGINEER BEFORE THE BITUMINOUS WEARING COURSE IS PLACED BY THE BITUMINOUS PAVING CONTRACTOR; HOWEVER, THE ENGINEER MAY DIRECT THE CONTRACTOR NOT TO PLACE THE LOOP DETECTORS IN THE ROADWAY UNTIL PAVEMENT MARKINGS AND LANE STRIPING HAS BEEN DETERMINED AND/OR PLACED.
2. AREA TO BE SAW CUT SHALL BE THOROUGHLY CLEANED BY SWEEPING, WASHING, OR BLOWING SURFACE CLEAR OF DIRT AND DEBRIS.
3. LOOP DETECTORS AND LOOP DETECTOR HOME-RUN WILL BE MARKED ON PAVEMENT BY THE ENGINEER OR BY THE CONTRACTOR AS DIRECTED.
4. LOOP DETECTOR SAW CUTS SHALL BE A UNIFORM DEPTH OF 2-1/2" +/- 1/4" AND 1/8" WIDER THAN THE OUTER DIAMETER OF THE TUBING.
5. THE CONTRACTOR SHALL AVOID CROSSING CONCRETE JOINTS OR CRACKS. HOWEVER, IF A CONCRETE JOINT OR CRACK MUST BE CROSSED, THE CONTRACTOR SHALL USE THE JOINT/CRACK DETAIL SHOWN ON SHEET 2 OF 3.
6. ALL LOOP CORNERS SHALL BE SQUARE. CORNERS SHALL BE DRILLED WITH 1-1/2" DIAMETER DRILL TO A DEPTH OF 1/4" DEEPER THAN SAW CUT. CORNERS SHALL BE ROUNDED TO PREVENT DAMAGE TO THE CONDUCTORS OR TUBING.
7. ALL LOOP DETECTOR SAW CUTS SHALL BE CLEANED AND FLUSHED OF FOREIGN MATERIAL USING A COMBINATION OF AIR AND WATER, AND DRIED WITH COMPRESSED AIR PRIOR TO INSTALLATION OF LOOP DETECTOR CONDUCTORS. DRY SAWING DOES NOT REQUIRE WATER FLUSHING, HOWEVER, THE SAW CUT SHALL BE CLEANED OF ALL FOREIGN MATERIAL.
8. THE CONTRACTOR SHALL FURNISH AND INSTALL FROM THE END OF THE SAW-CUT TO THE ADJACENT HANDHOLE A MINIMUM OF A 3/4" CONDUIT FOR A SINGLE LOOP DETECTOR OR AN APPROPRIATE SIZED CONDUIT BASED ON N.E.C. FILL RATIOS FOR 2 OR MORE LOOP DETECTORS.
9. BEFORE INSTALLATION OF LOOP DETECTOR CONDUCTORS, THE CONTRACTOR SHALL PLACE A BEAD OF APPROVED LOOP DETECTOR SEALANT IN SAW CUT SLOT TO WITHIN 6" OF THE CONDUIT THAT RUNS FROM THE END OF THE SAW-CUT TO THE ADJACENT HANDHOLE.
10. THE CONTRACTOR SHALL PLACE THE CLEAN AND DRIED LOOP DETECTOR CONDUCTORS CONTINUOUS WITH 4 TURNS OF WIRE AND WOUND IN A CLOCKWISE DIRECTION.
11. THE LOOP DETECTOR CONDUCTORS SHALL BE PUSHED TO THE BOTTOM OF THE SAW-CUT WITH A BLUNT INSTRUMENT TO AVOID DAMAGING TUBING OR CONDUCTORS. THE CONTRACTOR SHALL INSTALL 3/4" DIAMETER BY 2" BACKER ROD AT 2' INTERVALS TO ENSURE THAT THE CONDUCTORS ARE AT THE BOTTOM OF THE SAW CUT.
12. LOOP DETECTOR CONDUCTORS SHALL BE TWISTED 3 TURNS PER FOOT THROUGH THE CONDUIT TO THE SPLICE IN THE HANDHOLE.
13. LOOP DETECTOR LEAD-IN CONDUIT SHALL BE SEALED WITH DUCT SEAL OR OTHER APPROVED SEAL TO PREVENT LOOP DETECTOR SEALANT FROM ENTERING CONDUIT.
14. SEAL LOOP DETECTOR CONDUCTORS WITH A MN/DOT APPROVED LOOP DETECTOR SEALANT AS LISTED ON THE MN/DOT APPROVED PRODUCTS LIST (APL) AND IN ACCORDANCE WITH THE MANUFACTURER'S INSTRUCTIONS.
15. THE LOOP DETECTOR ROADWAY CONDUCTORS AND THE LOOP DETECTOR LEAD-IN CABLE CONDUCTORS SHALL BE PROPERLY PREPARED AND CLEANED BEFORE SPLICING. ROUGHEN CABLE JACKET WITH SAND PAPER TO ENSURE GOOD ADHESION WITH SPLICE KIT.
16. LOOP DETECTORS SHALL BE SPLICED USING AN APPROVED SPLICE KIT AS LISTED ON THE MN/DOT APPROVED PRODUCTS LIST (APL). MN/DOT APPROVED SPLICE KITS SHALL BE INSTALLED, EITHER ACCORDING TO MANUFACTURER'S INSTRUCTIONS, OR BY AN ALTERNATE METHOD APPROVED BY THE ENGINEER.
17. PRIOR TO FURNISHING AND INSTALLING THE APPROVED LOOP DETECTOR SPLICE KIT, THE CONTRACTOR SHALL SOLDER THE ENDS OF THE LOOP DETECTOR LEAD-IN CONDUCTORS TO THE ROADWAY LOOP DETECTOR CONDUCTORS, AND SHALL FURNISH AND INSTALL AN APPROPRIATE SIZED WIRE NUT TO THE SOLDERED ENDS PRIOR TO INSTALLATION OF THE SPLICE KIT.
18. SPLICE KITS SHALL BE FURNISHED AND INSTALLED IN HANDHOLES IN SUCH A MANNER AS TO ENSURE THAT EACH SPLICE KIT IS SUSPENDED AND/OR SECURED NEAR THE TOP OF THE HANDHOLE TO THE SATISFACTION OF THE ENGINEER (PLACING SPLICE KITS ON TOP OF THE ELECTRICAL CABLES AND CONDUCTORS IS NOT ACCEPTABLE).

APPROVED DECEMBER 11, 2009

STATE DESIGN ENGINEER

STATE OF MINNESOTA
DEPARTMENT OF TRANSPORTATION

SAW CUT LOOP DETECTORS
NOTES

SPECIFICATION
REFERENCE

2565

STANDARD
PLATE
NO.

8130E
3 OF 3