

Design and Development Principles for Livable Suburban Arterials

UNIVERSITY OF MINNESOTA

calaumn
Design Center
for American Urban Landscape

**CENTER FOR
TRANSPORTATION
STUDIES**

Research



© 2001 **Design Center for American Urban Landscape**
College of Architecture and Landscape Architecture
University of Minnesota

Design Center Project Team: William Morrish, Director; Carol Swenson, Project Manager; Dax Bennett; Regina Bonsignore; Daniel Marckel; Laurie McGinley; Wira Noeradi; Gia Pionek; Jason Zimmerman; and Heather Wainwright, Production Assistance

Project Consultants: Frederick Dock, Meyer, Mohaddes Associates, Inc. with Jaimison Sloboden and Ramana Murthy Koti

Project Partners: Minnesota Department of Transportation and the North Metro I-35W Coalition through grant funding from the Metropolitan Council through the Livable Communities Demonstration Account of the Metropolitan Livable Communities Fund.

This project was financed in part by the Minnesota Department of Transportation, Office of Research Services through the Center for Transportation Studies, University of Minnesota.

Additional funding for this project was provided by the McKnight Foundation. Additional funding for this report and other Design Center publications is made possible through support from the University of Minnesota and grants from the Dayton Hudson Foundation for Dayton's and Target Stores.

The University of Minnesota is committed to the policy that all persons shall have equal access to its programs, facilities, and employment without regard to race, color, creed, religion, national origin, sex, age, marital status, disability, public assistance status, veteran status, or sexual orientation.

The Geographic Information System (GIS) Maps used in this report are provided to you "as is" and without any warranty as to their performance, merchantability, or fitness for any particular purpose. The Design Center does not represent or warrant that the GIS Maps are error-free, complete, current, or accurate. You are responsible for any consequences resulting from your use of the GIS Maps or your reliance on the GIS Maps.

Data for these GIS Maps were provided courtesy of the North Metro I-35W Corridor Coalition. Sources include: North Metro I-35W Corridor Coalition, City of Arden Hills, City of Blaine, City of Circle Pines, City of Mounds View, City of New Brighton, City of Roseville, City of Shoreview, Anoka County GIS, Ramsey County Surveyor's Office, The Lawrence Group, PlanSight, LLC, Demographic Technologies, and the Design Center for American Urban Landscape.

This publication is available in alternative formats upon request. Please contact Design Center for American Urban Landscape, Suite 222, 1313 Fifth Street S.E., Minneapolis, MN 55414-1546, Phone: (612) 627-1850, Fax: (612) 627-4124, Web: <http://www.cala.umn.edu/dcaul/dcaul.html>

Technical Report Documentation Page

1. Report No. MN/RC – 2001-17	2.	3. Recipients Accession No.									
4. Title and Subtitle DESIGN/DEVELOPMENT PRINCIPLES FOR LIVABLE SUBURBAN ARTERIAL ROADWAYS		5. Report Date June 2001									
		6.									
7. Author(s) Frederick Dock William Morrish Carol Swenson		8. Performing Organization Report No.									
9. Performing Organization Name and Address Design Center for American Urban Landscape 1313 5th St. S.E., Suite 222 Minneapolis, MN 55414		10. Project/Task/Work Unit No.									
		11. Contract (C) or Grant (G) No. c) 74708 wo) 154									
12. Sponsoring Organization Name and Address Minnesota Department of Transportation 395 John Ireland Boulevard Mail Stop 330 St. Paul, Minnesota 55155		13. Type of Report and Period Covered Final Report 2001									
		14. Sponsoring Agency Code									
15. Supplementary Notes											
16. Abstract (Limit: 200 words) <p>Previous research conducted by the Design Center for American Urban Landscape at the University of Minnesota suggests a need to develop a hierarchical network of arterials that would accommodate contemporary and future activity and movement patterns in suburban areas.</p> <p>This research project investigated the interaction between road section design and adjacent site design by applying livable community principles and developing a set of design criteria that would guide coordination of land use and transportation planning. The research hypothesized a need for a minimum of three roadway prototypes, district planning capabilities, and an integrated land use and transportation planning approach.</p> <p>Research findings indicate that a hierarchical network is feasible under the following circumstances:</p> <ul style="list-style-type: none"> - The district network assumes arterial segments designed at different speeds. - Urban design performance criteria are used at the beginning of the planning process to establish quantitative measures. - Spacing of controlled intersections corresponds to road speed design. - Urban design templates, keyed to road design speed, are used to guide design of areas adjacent to the intersections. - The existing development context becomes the basis for balancing activity and moment and for phasing change in the built environment. 											
17. Document Analysis/Descriptors <table style="width: 100%; border: none;"> <tr> <td style="width: 50%;">Flexible road design</td> <td style="width: 50%;">Urban design</td> </tr> <tr> <td>Land use planning</td> <td>Urban planning</td> </tr> <tr> <td>Context-sensitive road design</td> <td>Livable streets</td> </tr> <tr> <td>Suburban roadways</td> <td></td> </tr> </table>		Flexible road design	Urban design	Land use planning	Urban planning	Context-sensitive road design	Livable streets	Suburban roadways		18. Availability Statement <p>No restrictions. Document available from: National Technical Information Services, Springfield, Virginia 22161</p>	
Flexible road design	Urban design										
Land use planning	Urban planning										
Context-sensitive road design	Livable streets										
Suburban roadways											
19. Security Class (this report) Unclassified	20. Security Class (this page) Unclassified	21. No. of Pages 84	22. Price								

Design and Development Principles for Livable Suburban Arterials

Center for Transportation Studies Research Project 99025

Final Report

Prepared by

William R. Morrish
Carol J. Swenson
Design Center for American Urban Landscape
College of Architecture and Landscape Architecture
University of Minnesota

and

Frederick C. Dock
Meyer, Mohaddes Associates, Inc.

June 2001

Prepared for

Minnesota Department of Transportation
Office of Research Services
Mail Stop 330
395 John Ireland Boulevard
St. Paul, Minnesota 55155

Center for Transportation Studies
University of Minnesota
200 Transportation and Safety Building
511 Washington Avenue S.E.
Minneapolis, Minnesota 55455

The opinions, findings and conclusions expressed in this publication are those of the authors and do not necessarily represent the views or policy of the Minnesota Department of Transportation or the Center for Transportation Studies, University of Minnesota. This report does not contain a standard or specified technique.

Table of Contents

Executive Summary	1
Introduction	3
Creating an Integrated Design Framework	
Setting a New Dimensional Baseline	11
Components of the Design Framework	18
Design Elements	20
Arterial Roadway Prototypes	26
Urban Design Templates	32
Case Study Application	
Background	47
Livable Community Context.....	50
Lexington Avenue Analysis.....	62
Subregional Network Building.....	70
Conclusion	77
Bibliography	77

List of Tables

Table 1	Operating Characteristics of Roadway Prototypes	30
Table 2	Lexington Avenue Activity	62

List of Maps

Map 1	I-35W Coalition Communities	49
Map 2	Livable Community Opportunity Areas	51
Map 3	Suburban Activity Centers	53
Map 4	Suburban Arterial Segments Adjacent to Parks and Open Space.....	55
Map 5	Suburban Arterial Segments Adjacent to Residential Parcels	57
Map 6	Commercial and Industrial Land Uses and Adjacent Arterials	59
Map 7	Transportation Network	61
Map 8	Subregional Application of Urban Design Templates	71
Map 9	Network Application: Intersection Analysis	72
Map 10	Arterial Network Schematic	73

List of Figures

Figure 1	New Brighton Town Center	1
Figure 2	Highway 10, Mounds View	1
Figure 3	Old City/Suburb County Road Development Pattern	3
Figure 4	New Metropolitan Community Arterial Development Pattern	4
Figure 5	Subregional Transportation Planning Principles and Themes	6

Figure 6	Scales of Suburban Activity	7
Figure 7	Integration of Movement and Activity	8
Figure 8	Components of an Integrated Design Framework	11
Figure 9	Minor Arterial Design Speed Prototypes	13
Figure 10	Scale of Planning Area Prototypes	15
Figure 11	Combined Thresholds Define Boundaries of Place	17
Figure 12	Urban Design Elements	18
Figure 13	Roadway Prototypes	19
Figure 14	Urban Design Templates for Planning Areas	19
Figure 15	Hennepin Avenue, Minneapolis, Minnesota	27
Figure 16	Town Center Avenue Section Layout	27
Figure 17	Excelsior Boulevard, St. Louis Park, Minnesota	28
Figure 18	Community Boulevard Section Layout	28
Figure 19	Ramsey County Highway 96, Shoreview, Minnesota	29
Figure 20	Subregional Expressway Section Layout	29
Figure 21	Road Design Speed and Access Management Chart	31
Figure 22	Urban Design Templates for Suburban Arterial Intersections	33
Figure 23	Case Study Subregion: I-35W Coalition	47
Figure 24	Case Study Arterial Segment: Lexington Avenue	47
Figure 25	Activity Centers	52
Figure 26	Arterial Segments Adjacent to Open Space	54
Figure 27	Arterial Segments Adjacent to Residential Parcels	56
Figure 28	Commercial and Industrial Land Uses	58
Figure 29	Transportation Network	60
Figure 30	Existing Conditions of Lexington Study Segment	63
Figure 31	Livable Community Option of Lexington Study Segment	63
Figure 32	Template Application	65
Figure 33	Road Network Redesign	65
Figure 34	Placemaking Case Study	66
Figure 35	Lexington and County Road F	67
Figure 36	Existing Conditions at Lexington and County Road F	67
Figure 37	Community Boulevard Prototype	67
Figure 38	Schematic Urban Design	67
Figure 39	Lexington Avenue and County Road D	68
Figure 40	Existing Conditions at Lexington Avenue and County Road D	68
Figure 41	Town Center Avenue Prototype	68
Figure 42	Schematic Urban Design	68
Figure 43	Lexington Avenue and County Road C	69
Figure 44	Existing Conditions at Lexington Avenue and County Road C	69
Figure 45	Town Center Avenue Prototype	69
Figure 46	Schematic Urban Design	69
Figure 47	Urban Design Templates for Suburban Arterial Intersections	70
Figure 48	Silver Lake Road, New Brighton	75
Figure 49	I-35W and County Road C, Roseville	75

EXECUTIVE SUMMARY



Figure 1. *New Brighton Town Center, a transit-supportive redevelopment in a first-ring suburb.*



Figure 2. *Highway 10, a recent county turn-back, as it passes through the City of Mounds View.*

Current regional and local public policy directions, along with changes in the market place, are generating a new range of development models that emphasize mixed-use and multi-modal transportation. These models, coupled with an increasing number of available redevelopment and renovation sites, present the opportunity to re-organize and re-engineer the suburban fabric for greater mobility and increased diversity.

Coordination of land use and transportation planning is commonly acknowledged as the starting point for this transition. It is predicated on the inextricable tie between two basic community functions: activity and movement. Coordination is further necessitated by shifting public concern that existing and future public resources (e.g., the built infrastructure, water, air, and open spaces) be strategically invested and maintained for long-term benefit.

Despite the growing body of literature about the necessity to integrate land use and transportation planning, there is little information available on how to initiate such a process within fully developed suburbs. Conventional planning tools are shaped by the underlying cultural attitudes of the generations that developed them or by the limitations of the knowledge and theoretical biases underpinning the research that produced them. New planning tools, while often more sympathetic to the concepts of mixed-use and multiple function, are often site specific or narrow in focus thus stopping short of methods for weaving the pieces together to form a regional network of activity and movement.

For the past five years, the Design Center for American Urban Landscape in the College of Architecture and Landscape Architecture at the University of Minnesota has been exploring the juncture points of all the systems that contribute to a dynamic regional—metropolitan—network. Believing in the importance of starting with the resources at hand, the Design Center has focused on the older suburban areas of the Minneapolis-St. Paul Region. This research has been richly supplemented by ongoing collaboration with the political and professional leadership of these communities. The minor arterial road system, largely in the form of county roads, emerged as the critical beginning point for this research.

The Livable Suburban Arterials research project explores how design of the road and site interact to create that inextricable tie between land use and transportation. It also seeks to offer an urban design framework and initial set of tools that enable land use and transportation planners to open a discussion about how to move forward in a collaborative planning effort.

INTRODUCTION

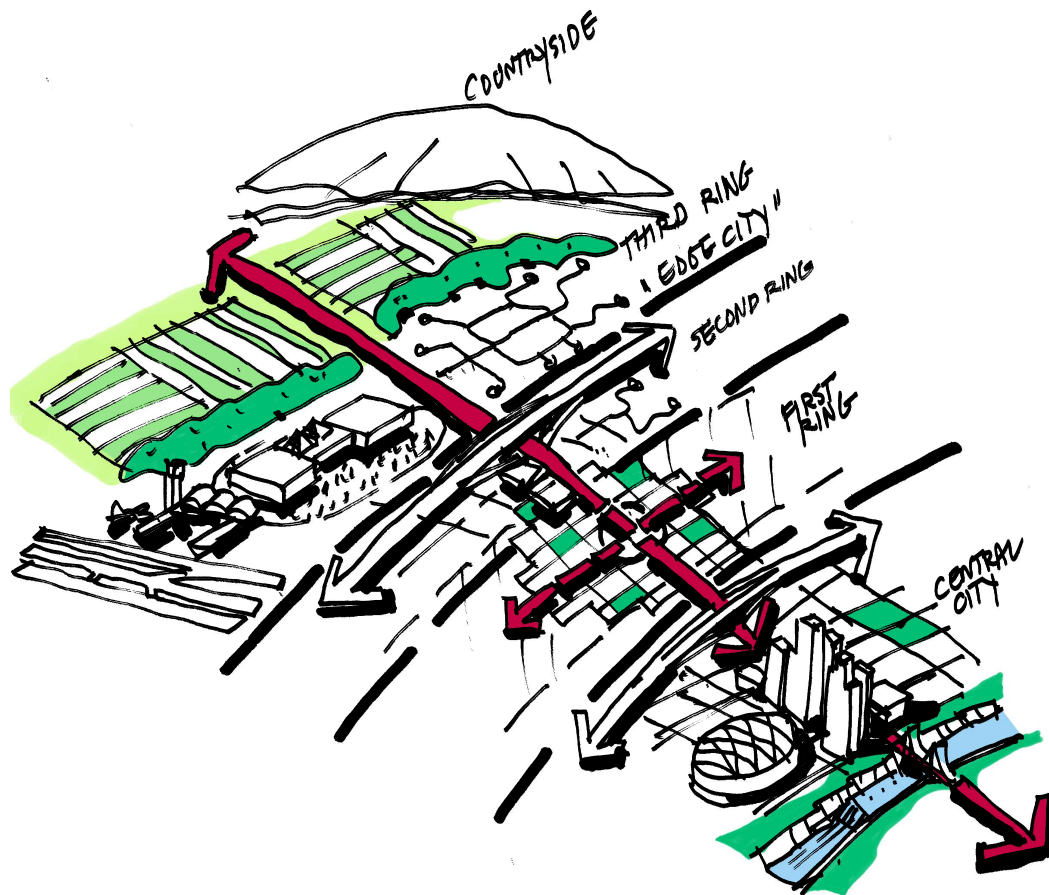

Figure 3. Old City /Suburb County Road Development Pattern.

WILLIAM R. MORKISH 2000

From Single Purpose to Multi-function: The Changing Nature of the Suburban Arterial Network

From 1950 to 1980, the Minneapolis-St. Paul region grew in population from 1,185,694 to 1,985,873 persons, added 63 new municipalities, and expanded its job base by 138 percent. This growth occurred under a regional planning paradigm that assumed an orderly progression from the middle to the edge: the center city gave birth to the first ring, which spawned the second ring, and so on. The paradigm further assumed that the typical household structure contained two parents, one of whom worked, and children.

From a regional perspective, the simplified trajectory and assumptions of this paradigm had their utility, but from a local or county perspective, the experience of growth was less than simple and orderly. And although there may have been a prevailing commute pattern into the central cities in the 1950s, the 1960s brought shopping malls, corporate campuses, and office parks to the suburbs. These new development types began to disperse throughout the region and the underlying activity and movement patterns changed along with them.

Today's regional landscape is testimony to this phenomenon, and the minor arterial network its prime example. Around this skeletal structure consisting of county roads and state trunk highways is a complex mix of land uses. Single family homes, regional malls, trucking terminals, and regional employment centers now seek direct access to the road network. Originally built as single function, the nature of the arterial road is now multi-function. It must carry all types of trips, accommodate all types of transportation modes, and service all types of sites and land uses.

Despite the adjacency of development to arterials, which gives them their multi-function character, the two realms are frequently at odds with one another and often cancel out each other's respective benefits for communities. Much of this tension originates in how land use and transportation are regulated and managed. Outside of the right-of-way, land is controlled by municipalities, and there is little continuity among them with regard to application of land use regulations. Site design standards, zoning codes, land use criteria and attitudes about property rights vary widely. Inside the right-of-way, we have an arterial network that is largely managed by counties as part of the regional transportation system. The primary management goal is to move vehicles and, under this goal, uniformity and flow are priority concerns especially when it comes to issues of safety, congestion reduction, and meeting travel demand needs.

Meanwhile, the metropolitan region continues to develop as a web of networks, services, and places that, while having centers or hubs of activity, is essentially distributed across the landscape. Increasingly, residents of the region assume and expect seamless access to jobs, housing, and amenities. The planning question raised by this public expectation is at the core of this research project: *how do we begin to align a very disparate set of land use and transportation remnants to create the means for a higher quality of life?*

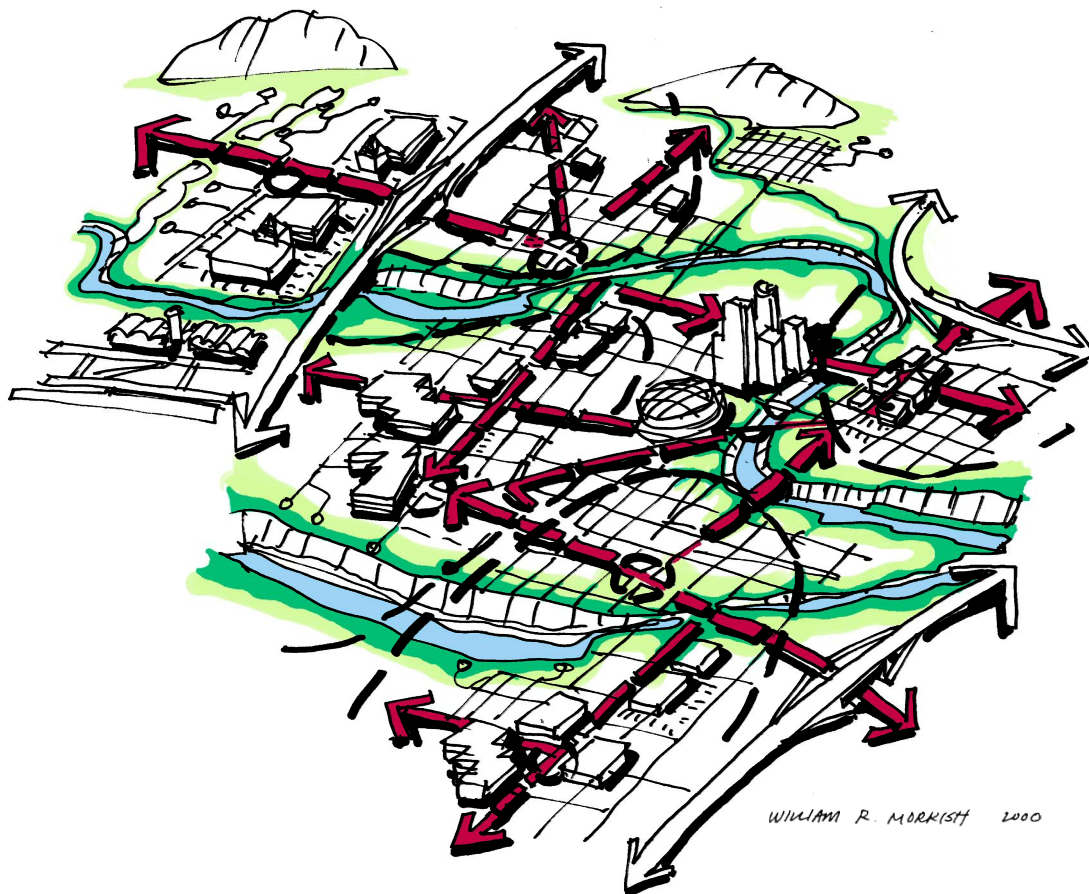

Figure 4. New Metropolitan Community Arterial Development Pattern.

Livable Suburban Arterials Research and Report

The livable suburban arterials research project sets out to investigate the interaction between road section design and adjacent site design and to develop a set of design criteria that would guide alignment of land use and transportation. The research hypothesizes that:

- a minimum of three arterial roadway prototypes is needed to serve travel demands and that there are three types of activity levels in suburban communities;
- district planning capabilities are desirable rather than planning roadways and sites in isolation; and
- an integrated planning approach, that is one that gives equal consideration to land use and transportation throughout the planning process, is preferable to independent planning.

Livable community principles and urban design analytical methods provide the means to frame research questions and integrate land use and transportation.

The first component of the study generates a design framework that synthesizes land use and road design into five elements that address both sides of the right-of-way. Out of these elements, three roadway prototypes and six urban design templates are developed as tools for applying the principles embedded in the design elements. The second component of the study applies the tools in a case study. The study looks at two geographic areas, a subregion composed of seven communities and a 5.5 mile arterial segment. It concludes with a proposed strategy for using the templates and prototypes to build a movement and activity network in suburban areas of a metropolitan region.

Study Assumptions and Approach

Movement: District Network

The suburban arterial road network, both in the context of traffic mobility and in its relationship to development opportunity, is a pivotal tool for preserving quality of life and for attracting economic development and redevelopment opportunities. The mobility issue can be addressed by developing a more finely grained network of arterial streets, which allows traffic to distribute over a larger area at lower concentrations. Simultaneously, a wider range of development opportunity sites are created that can support a broader range of development types, which suggests a “District Network” approach to planning.

Walter Kulash, in his 1997 transportation study for the NW I-35W Coalition, proposed five principles that serve as the basis for structuring a district network. The principles, as presented in Kulash’s summary memo, emphasized the use of lower design speeds, attention to the arterial network, incorporating multi-modal and land use aspects into road planning, and adding new roads to the network. Kulash recommended adoption of new roadway definitions to create a network of boulevards and avenues that would have low design speeds (below 40 m.p.h.) and would serve multi-modal uses.

In a companion 1998 study, transportation planner Fred Dock pursued research on five multi-modal transportation planning themes that would accommodate subregional movement needs. Findings from his research touched on five themes that provided more guidance for planning a district network. These themes emphasized development of outcome-based performance criteria for the transportation network and transportation demand forecasting at a subregional scale to provide a more reliable representation of the future transportation picture. This concept was reinforced by illustrating the layered strata of different travel demand patterns (“markets”) that combine to create the volume of traffic on the arterial network.

Under the current research, the five themes were used to expand the district network concept to include a functional classification system with three types of road sections:

1. At-grade Expressway (a 55 m.p.h. design speed, four- to six-lane cross section intended for traffic movement over longer distances)
2. Boulevard (a 45 m.p.h. design speed, four-lane road that connects between subregional activity centers)
3. Avenue (a 35 m.p.h. design speed, four-lane road with parking for areas with commercial land uses)

The road section types provide the criteria for defining a lattice of planning areas (a District Network) that integrate transportation planning with development opportunities.

Livable Community Transportation Planning Principles, Kulash, 1997.

1. Adopt low design speeds whenever feasible.

The single factor of design speed is so critical to the quality of Coalition roads it is the primary principle. A low design speed (no greater than 60 k.m.h. or 37 m.p.h.) is critical to many important qualities of Coalition roads, especially those in predominately residential and commercial areas. Contrary to common thinking, reducing design speed will not decrease the volume of vehicles that travel on a stretch of road. Rather, it increased the volume.

2. Pay particular attention to the surface street network.

This is the network on which the Coalition's economic development asset is located. The quality of the surface arterial network is a far more important factor in the Coalition's ability to keep and attract employment than is the level of service on the freeway system.

3. Plan for multi-modal uses of the road.

Within the right-of-way itself, alternative transportation is encouraged by low design speeds, signalization, pedestrian treatments at intersections, and provision for bus stops. More important than the road right-of-way, are measure involving roadside land use. These measures, the responsibility of the Coalition cities' site planning regulation, can concentrate development into transit-friendly nodes, provide off-street bicycle and pedestrian paths, and arrange industrial land uses into configurations that are friendly to employee transit use.

4. Incorporate land use into the planning process.

The roadside land use, existing or proposed, should be a major factor in road design. Attention to this factor assists in establishing "themes" that give a road distinctive character and in determining appropriate design speeds. One road may have several themes as land use changes from residential, commercial, industrial, or open space.

5. Add new network.

Rather than continuing to widen the existing network, create a redundant arterial network for major employment work places. This network is particularly important for freight and employee travel, giving drivers an option to avoid peak hour congestion on the freeways and distributing the loadings at freeway interchanges throughout the Coalition.

District Network Planning Themes, Dock, 1998.

1. Outcome-Based

Outcome-based planning focuses on activity modeling, which looks at who, what, where, and when people are actually traveling. This focus is different from conventional needs-based transportation planning. Outcome-based planning uses goals established by the Coalition to develop performance criteria for the transportation network.

2. Subregional Scale

Under conventional transportation planning and development approval processes, assessments only consider impacts on the regional or local network. Working at a subregional scale, with linkages to the regional mode, would be more inclusive and representative of how the network would function on a day-to-day basis.

3. Leveraging Local Resources

Currently, transportation planning decisions are made on a project basis, often disregarding opportunities to leverage state and local financial resources. A more comprehensive approach would encourage consideration of enhancements to alternative modes of travel.

4. Quality of Life Criteria

Planning that emphasizes quality of life issues rather than level-of-service demands will generate very different results for communities. Inherent in "quality of life" is consideration of the experience of the ride and of the impact of the road on different land uses in communities. Responses to these considerations will likely lead to modifications in choice of transportation and in road standards and design.

5. Integration of Land Use with Socioeconomic Data as Forecasting Measures

Socioeconomic data are the measures most frequently used for transportation forecasting. These data are limited as surrogate measures for travel patterns and use of the road system. Enhancing these measures with land use data will provide a more reliable representation of the future transportation picture.

Figure 5. Subregional Transportation Planning Principles and Themes. Source: I-35W Corridor Coalition Comprehensive Livable Community Urban Design and Transportation Study, Phase I, Track 1 Report, May 1998.

Activity Areas: Neighborhood, Town, Subregion/Region

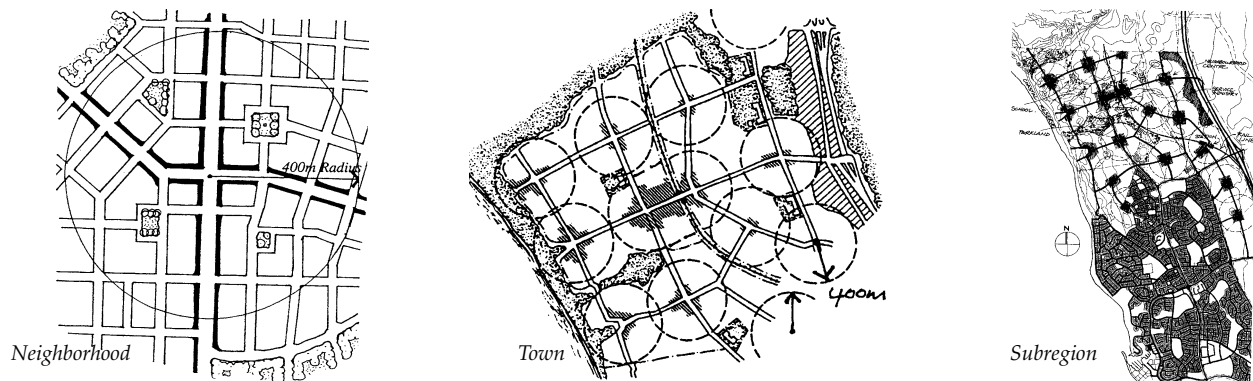

Figure 6. Scales of Suburban Activity: neighborhood, town, and subregional. Source: Western Australian Liveable Neighbourhoods: Community Design Code.

Current research in urban design and sustainability points to clustering a mix of activities, building types, and land uses and to providing access to a variety of transportation modes—especially walking—as the opportunity of the future. From an economic and environmental perspective, the advantage of this type of urban form is long-term reduction of automobile dependency, increased energy efficiency, and maximum utilization of existing infrastructure investments. From a community building perspective, the advantage is encouraging long-term neighborhood viability through physical design that promotes safety, use of amenities, social connections, and civic participation.

Research further shows that three levels of activity are desirable: high intensity areas where job and housing densities can sustain a diverse economic base and multi-modal transportation; medium intensity areas that support smaller businesses and daily shopping, a live-work community, and give local identity to communities; and low intensity areas that connote neighborhood-scale connection. The distribution and balance of these activity centers will vary by economic region and geographic location. As noted in the Western Australian *Liveable Neighbourhoods: Community Design Code* (p. 3), the design and layout of these centers:

- Sets the urban character and sign of an area;
- Allows or inhibits social interaction and thereby influences the likelihood of community formation;
- Forces car dependence or reduces it by encouraging the non-car modes of walking, cycling and public transport;
- Gives or denies access to facilities for all users of the urban environment; and
- Provides or prevents opportunities for locally based business and employment.

American urban designers and planners use many names to label and distinguish between different types of activity centers. Transit-oriented or transit-supportive development nodes and suburban activity centers are the most frequently used of these terms. As these centers get up and running, empirical data about densities, business mixes, transportation mode choice, etc. is being gathered to complement projects generated by theoretically-based models. And although it is not pragmatic to expect suburban communities to immediately adopt and implement activity centers as a preferred urban form, it is realistic to expect communities to evolve gradually toward development patterns that can be sustained over time.

For the purposes of this study, these three types of activity centers are assumed to be a desirable development form and should be encouraged in land use and transportation planning and through design criteria and performance standards. This assumption does not suggest that low-density residential areas or subdivision would be phased out. Rather, it assumes that this development form is also desirable and would, in fact, have more long-term viability if a regional network of activity centers supported it.

ACTIVITY

Land-use zones

Urban Design Criteria

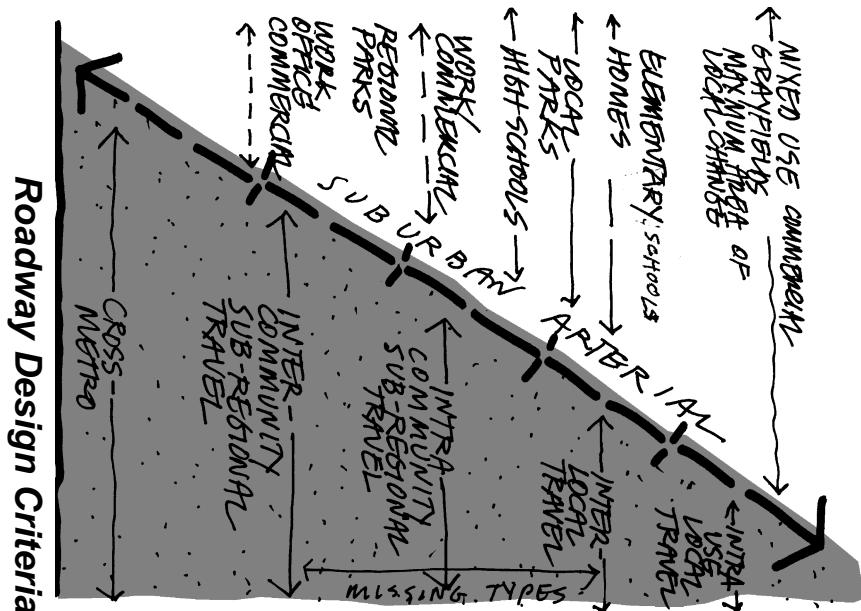
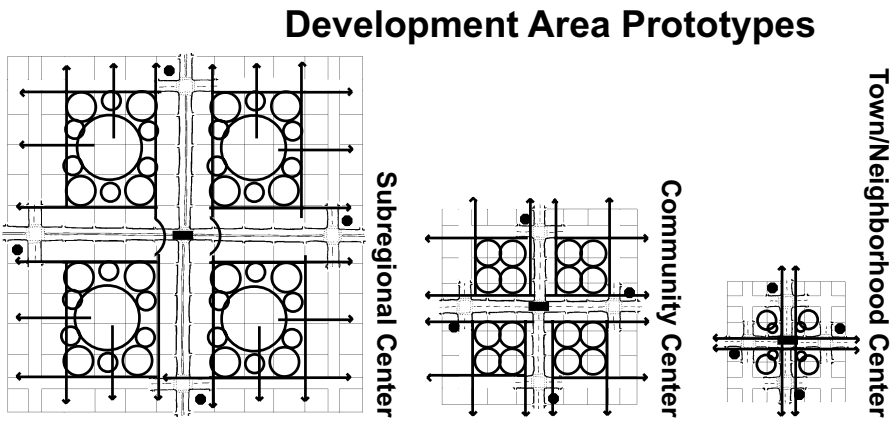

MOVEMENT

Transportation segments

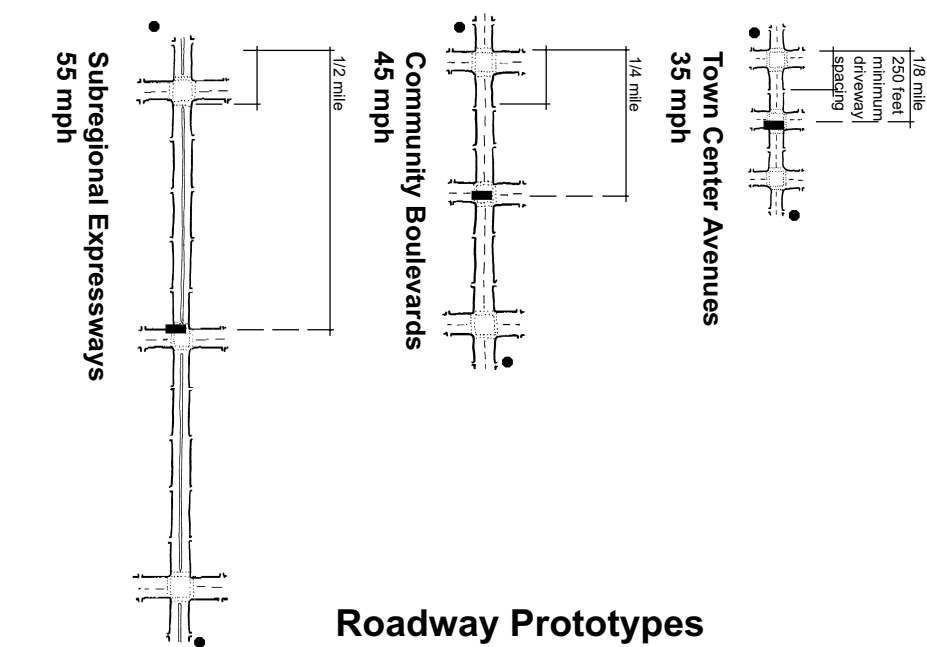

Roadway Prototypes

Figure 7. Integration of Movement and Activity.

Integration of Activity and Movement: Multi-Function Arterials

As the methods indicated by Dock and Kulash were explored for implementation, it became apparent that the criteria for design and application would need to integrate land use and roadway design elements. Development of such integrated criteria requires rethinking the roadway/land use relationship into its fundamental elements of activity and movement. Using the twin filters of activity and movement, the arterial network is revealed as a set of multi-function streets that serve as a nexus of land use and transportation. The combination of these two forces defines place.

The illustration on page 6 arranges land uses of increasing intensity from top to bottom and pairs them with roadways such that the diagonal defines the nexus condition and reinterprets, to a degree, the mobility-access diagram that is the basis for the roadway functional classification system of arterial, collector, and local streets. The topmost condition defines minor arterial streets that support mixed-use commercial corridors and the bottommost condition defines principal arterial streets that provide for cross-metro region travel. Conventional design models exist for both of these conditions.

What is interesting from a nexus standpoint is that a large amount of suburban activity takes place in the middle region of the illustration. Conventional road design models do not specifically address the multi-function nature of arterial streets in the middle region. A system is needed that recognizes these types of multi-function arterial streets and defines them from a combined land use and transportation context. That combined context suggests the need for a pattern language that pairs roadway design criteria (in terms of the maximum number of lanes and design speed) with urban design criteria (in terms of levels of activity, location of access, and relation to street).

CREATING AN INTEGRATED DESIGN FRAMEWORK

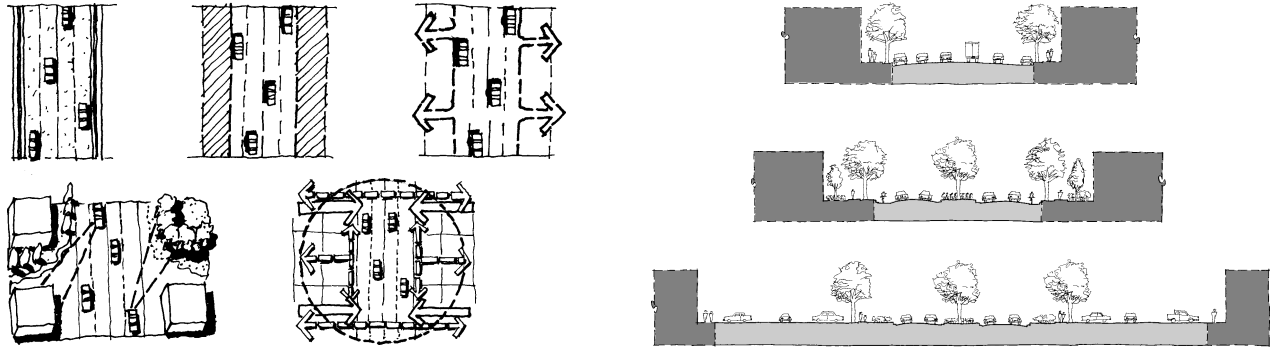

Figure 8. Components of an Integrated Design Framework.

Setting a New Dimensional Baseline of Roadway and Urban Design Criteria: Background

Converting a county road system into a livable suburban arterial network is as much an urban design issue as a transportation roadway design challenge. As the development market continues to evolve and community needs change, new work places and living spaces are being created which, in turn, are generating new movement and activity patterns. Out of this process, the suburban arterial is emerging as a multi-function road where as much attention must be paid to how the road integrates with neighboring land uses and development as to how it accommodates traffic volumes and speeds.

Conventional road design and development models do not adequately address the multi-function dimension, nor do they establish a hierarchy of roadway segments in the network, to address future land use mixes or their diverse range of movement needs.

A new dimensional framework is needed that pairs movement—roadway design criteria in terms of a maximum number of lanes and design speed—with activity—urban design criteria in terms of levels of activity, location of access, and relation to the street. The goal of the framework is to create legible, humane, and environmentally enriching roadways that meet the following urban design objectives:

- ability to accommodate a wide range of transportation modal options, particularly a rich pedestrian activity network;
- ability to support a wide range of mixed-use development options that transform roads into activity corridors; and
- ability to create a coherent subregional movement network that serves the diverse economic, social and environmental needs of metropolitan communities.

Establishing an integrated framework begins with an examination of the physical areas and the design fundamentals considered for each space. With these in hand, it is possible to define the relationship between road design and land use and to describe new design elements that transition from transportation and land use to movement and activity. **From this juncture, it is possible to develop a taxonomy of planning situations and a corresponding set of templates to guide design decision-making for each.**

The integrated framework proposed in this study addresses three basic movement flows characterized by the 35 m.p.h., 45 m.p.h., and 55 m.p.h. road design speeds, and three levels of activity intensity identified as neighborhood, town/community, and subregion.

This section of the report:

- describes characteristics of the influence thresholds created by different types of road design speeds and land use clusters and the movement - activity relationship between the two thresholds;
- details the design elements of the proposed design framework; and
- introduces roadway prototypes and urban design templates that can be used to apply the framework to the existing landscape.

Roadway Influence Threshold

A design framework approach requires developing functional characteristics of suburban arterial roadway segments based on land use, community character, and activity. These characteristics are listed and defined below.

Purpose:	The transportation function the road serves
Design Speed:	How fast traffic is expected to travel on the roadway
Access Spacing:	The intervals between signalized and unsignalized intersections and driveways
Type of Access:	Median treatments and driveway controls
Transit:	The type of transit service on the road
Pedestrian/Bicycle:	Provisions for non-auto modes
Parking Treatment:	The type of parking provided
Design Standards:	Controlling regulatory criteria used to derive the physical parameters of the roadway

Characteristics have been developed for three roadway prototypes: (1) the 35 m.p.h. design suitable for neighborhood or town centers; (2) the 45 m.p.h. design for intra-community trips; and (3) the 55 m.p.h. for subregional travel (see diagram on page 13). These prototypes were selected to establish the design criteria and as the initial patterns for urban design because they correspond to three dominant types of land use activity: neighborhood; town/community; and subregional/regional. They also accommodate three common trip lengths: 5 minute; 10 minute; and 20 minute.

The influence threshold of the roadway is determined by design elements that are speed related (e.g., stopping sight distances) and increase geometrically as travel speed increases. The nature of this relationship between speed and distance leads to wider clear zones adjacent to higher speed roadways. In this way, the roadway influence threshold expands farther from the centerline as speed increases, which effectively pushes land use farther from the roadway edge.

The roadway influence threshold for each of the three prototypes is illustrated and described in the diagram on the following page. The center intersection is assumed to be signalized; the surrounding intersections are unsignalized and indicate access spacing appropriate to the design speed; and the hatched area represents the required clear zone. The net effect is the creation of development areas that are quite different in size and activity potential and roadways that permit the driver to read and interact with the streetscape and the surrounding environment in different ways.

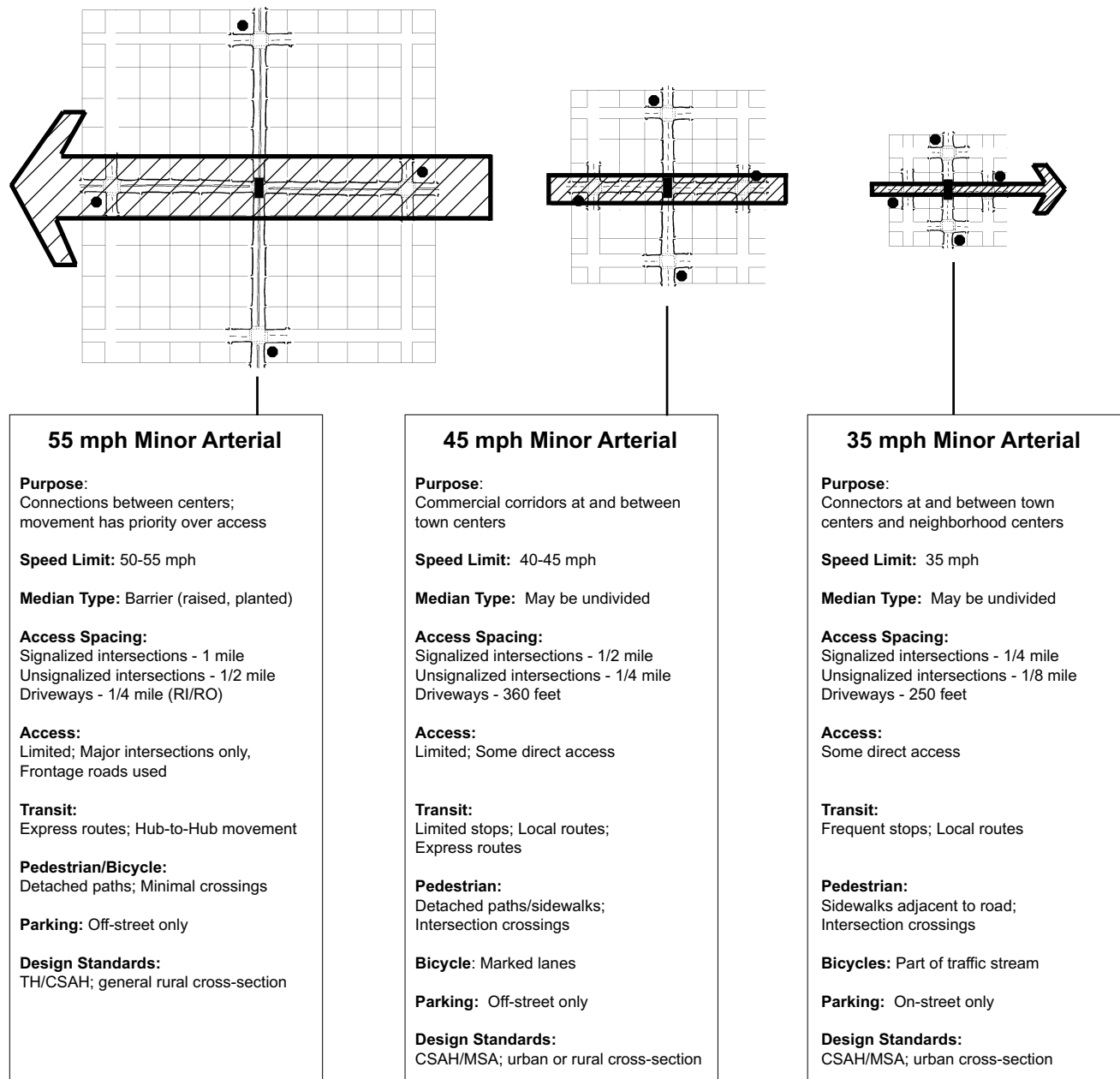

Figure 9. Minor Arterial Design Speed Prototypes.

Land Use Influence Threshold

As with the roadway, functional characteristics are needed for the planning area created by the clear zone and access spacing requirements associated with each roadway prototype. These characteristics address issues of urban design which give image and form to generic land use designations that have few if any visual or qualitative measures. The characteristics are listed and defined below.

Location:	Where a feature is placed in relation to other physical features
Scale:	The size and proportion to other objects within the same view
Mix:	Sets of uses and activities that make a neighborhood livable
Time:	How the physical structures support day and night routines, adapt to seasonal changes, and provide a sense of continuity
Movement:	Access to features within the area and the larger metropolitan setting

The land use or urban design influence thresholds correspond to three levels of activity intensity as they occur in the suburban landscape: subregional, community/town and neighborhood. A subregional activity center is a "jobs magnet" based upon retail, commercial, industrial activity or a mix of all three. The general scale of this type of center is larger, both in the size of the parcel and the building. There is limited or no visual image of the block as an organizing mechanism for building orientation or circulation. The economic vitality of the center is heavily dependent upon easy and immediate access to regional transportation systems.

A community/town center refers to mid-sized places that are usually dominated by one type of activity, but also have a mix of other activities that give a broader identity. Economic vitality, while not dependent upon immediate access to the regional systems, is closely tied to physical and visual access to the arterial network. Direct access to the arterial is not a requirement, in fact, these places may be better served by excellent internal circulation and limited access to arterials that flow smoothly.

The neighborhood center defines the third level of activity that invites pedestrian movement. Buildings are scaled smaller, blocks are an identifiable mechanism for organization and, while movement may be as intense as at a subregional center, it occurs at a slower pace that accommodates children and bicyclists. In the suburban context, the arterial that serves it becomes synonymous in nature to the urban neighborhood commercial street and the economic dependency upon the arterial as a place to locate for market purposes as well as acceptable land use.

In the diagram on the following page, the land use or urban design influence threshold is represented by the shaded area. The size and shape are established by the access zones associated with the intersecting roadways. In this diagram, rectangular shapes are shown because the intersecting roadways have different design speeds. (See page 16 for further explanation.)

The influence of urban design on the roadway is the inverse of the roadway influence threshold, also for speed related reasons. In this case though, the influence is a function of the view shed of the motorist on the roadway, which tends to narrow the faster a vehicle travels. At higher speeds, the motorist cannot absorb small-scale visual cues regarding the organization and type of activity associated with the land use. Hence, design elements that communicate this order (such as buildings, signage, and views) must be larger and widely spaced for the motorists to focus sufficient attention on them. Conversely, at lower speeds, design elements are visible at much closer spacing and with a resultant richness of character that is essentially invisible at higher speeds.

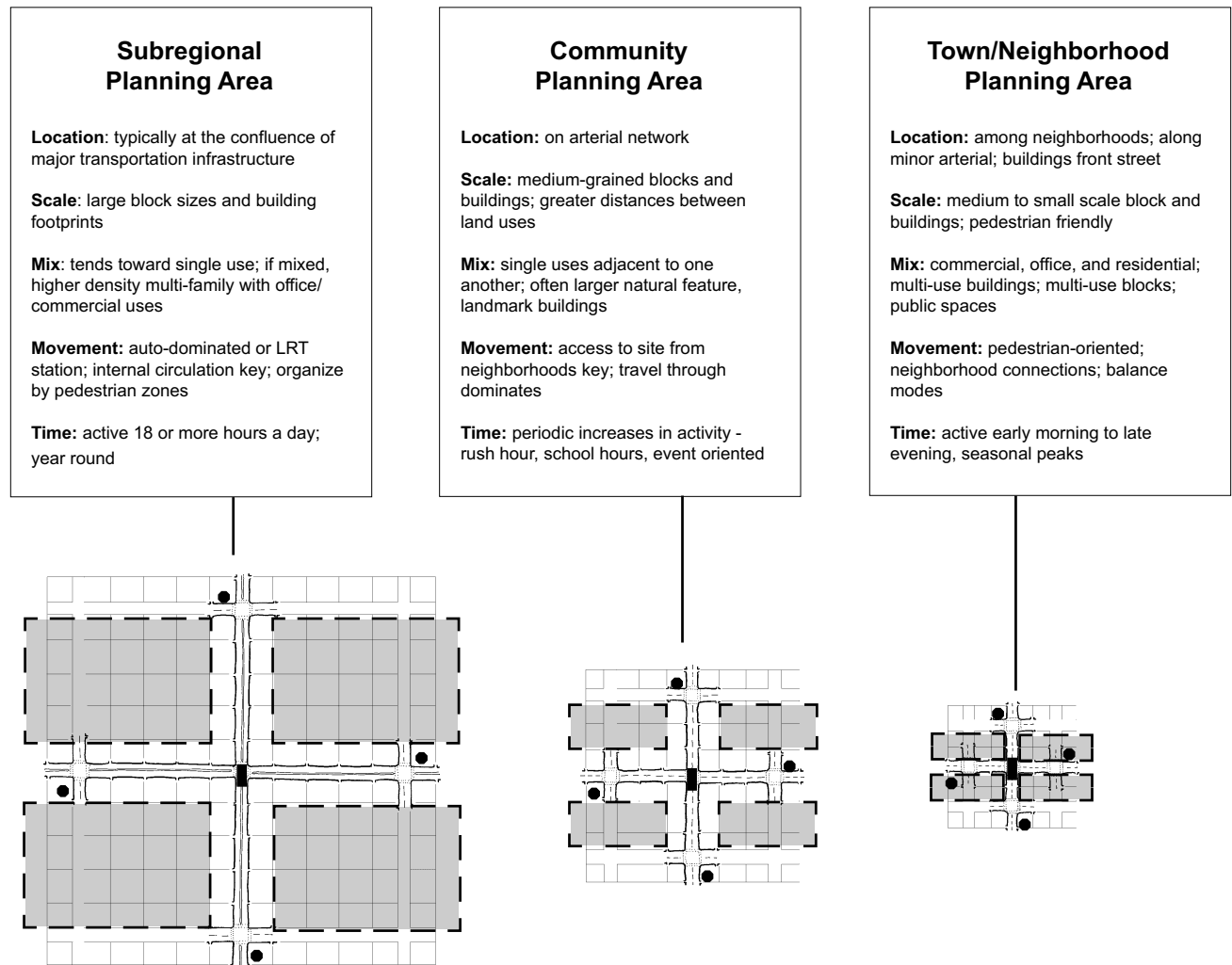

Figure 10. Scale of Planning Area Prototypes.

Integrated Activity and Movement Influence Thresholds

When the prototypes for roadway and urban design are combined, the basic elements of a design framework become evident as represented by the integration of the two influence zones. The combination of the two influence thresholds shows three distinct nexus points: one at either end that are represented by the endpoints of the spectrum of arterial types and one in the middle that corresponds to the multi-function arterial type. At the left side of the diagram, the roadway exerts control over the urban design component and results in activity patterns that need to be separated from the roadway, either through site design or linear buffers. At the right side of the diagram, urban design and land use activity are sufficiently intense to overwhelm the roadway function and suggest that the roadway needs to be designed accordingly. The middle ground represents conditions where both roadway and urban design need to be considered to create effective roads and effective development patterns.

Three conceptual roadway types are identified, one for each of the nexus points: subregional expressways, community boulevards, and town center avenues. **It is the integration of land use and transportation that establishes a core dimension of “place.”** Place, in turn, connotes qualitative characteristics that assist in framing the quantitative criteria applied in land use and transportation planning. For example, the term town center avenue suggests a landscaped street that is inviting to pedestrians and transit users, yet has a fair number of cars parked along it or moving at a slow, but steady pace. From a safety standpoint, the terms help to define the function and use of the road more clearly for pedestrians and drivers. From a design and planning standpoint, qualitative measures associated with the terms help to establish the desired balance between movement and activity.

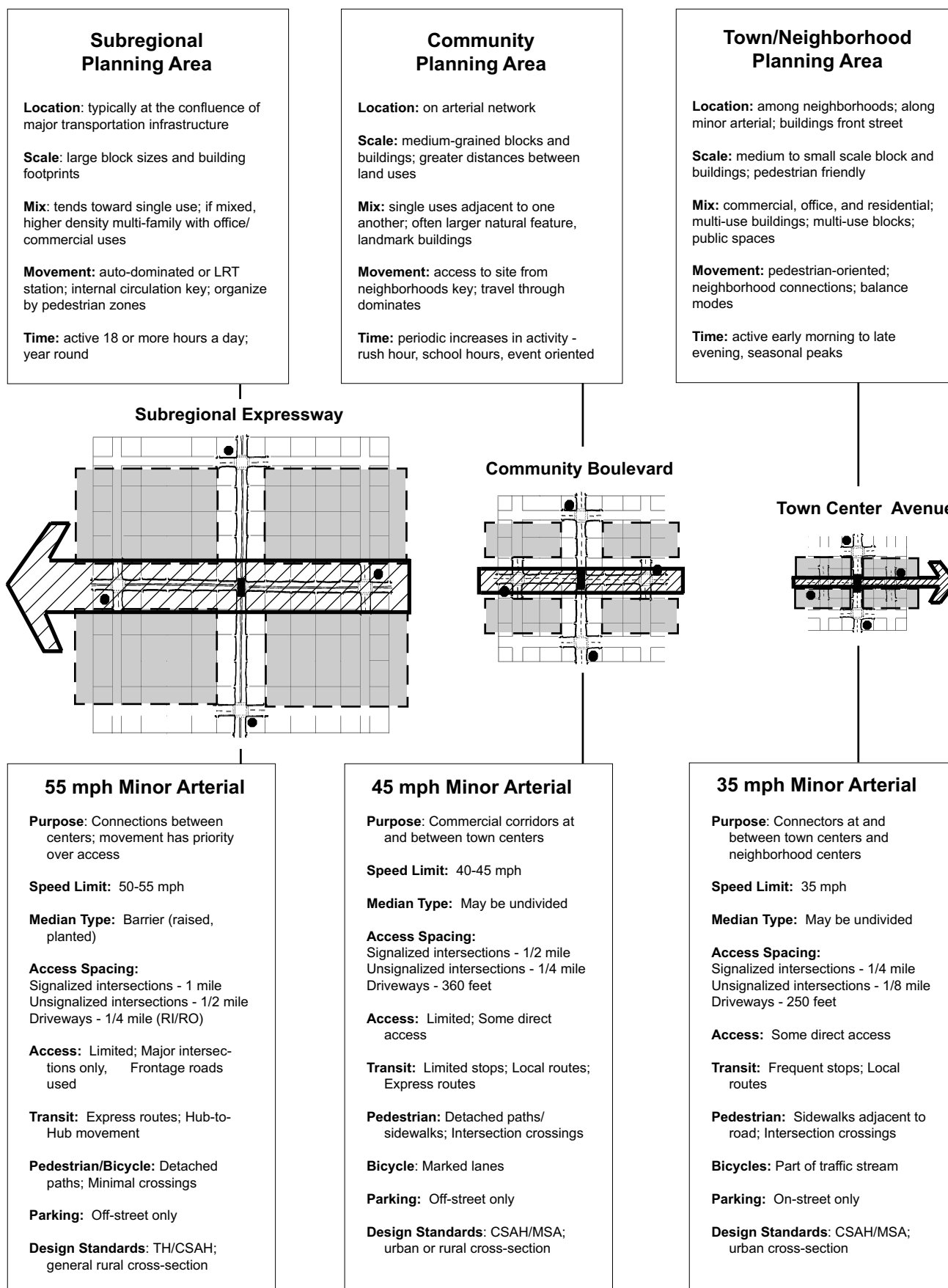
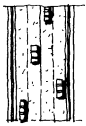

Figure 11. Combined Thresholds Define Boundaries of Place.

Components of the Design Framework

Within the activity and movement design framework are the working components that inform basic planning and design decisions about the roadway and the land adjacent to it. When activity and movement are considered simultaneously, performance standards for each must be represented in the decision-making equation. Design elements establish the variables of the equation, and the prototypes and templates establish the point of departure from which individual road segments and planning areas can be designed. This approach elevates urban design guidelines from tools to mitigate the negative effects of roadway speed to the terms by which speeds are established. Natural resources and cultural context, the two core ingredients of place, become the fulcrum that leverages the ubiquitous into the unique. Below, the components are introduced briefly; they explained in greater detail on the following pages.

Design Elements



Curb to Curb

Defines basic movement parameters: number of lanes, lane width, modes served, and edge and median condition

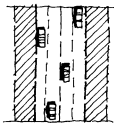

Right of Way

Defines the place between curb to curb space and adjoining property; establishes view shed parameters

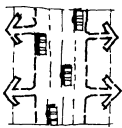

Access Management

Establishes frequency of access to property; speed related



View Shed

Defines relationship between adjacent land uses and road users; varies with rate of speed

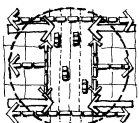

Community Connections

Defines planning areas served by roadways.

Figure 12. Urban Design Elements.

Roadway Prototypes

	<p>Town Center Avenues</p>	<p>35 mph; connectors at and between town centers and neighborhood centers</p>
	<p>Community Boulevards</p>	<p>40-45 mph; corridors at and between town centers</p>
	<p>Subregional Expressways</p>	<p>50-55 mph; at-grade highways where movement has priority over access</p>

Figure 13. Roadway Prototypes.

Urban Design Templates for Planning Areas

	<p>35/35 mph intersection</p>	<p>square planning areas of approximately 10 acres; minimum access spacing between access points is 250'; frequent pedestrian street crossings; location best for transit stop</p>
	<p>45/45 mph intersection</p>	<p>square planning areas of approximately 40 acres; minimum access spacing at 350'; internal pedestrian circulation preferred with marked crossings; location best for transit timed-transfer center</p>
	<p>55/55 mph intersection</p>	<p>square planning areas of approximately 160 acres; minimum access spacing at 500'; internal pedestrian and vehicular circulation required; location best for park and ride or off-street transit hub</p>
	<p>35/45 mph intersection</p>	<p>rectangular planning areas of approximately 20 acres; minimum access spacing at 250' or 350'; pedestrian crossing at intersection; location best for transit stop/route transfer</p>
	<p>35/55 mph intersection</p>	<p>rectangular planning areas of approximately 40 acres; minimum access spacing at 250' or 500'; pedestrian crossing minimal; internal pedestrian circulation required and internal vehicular circulation preferred; location best for transit park & ride</p>
	<p>45/55 mph intersection</p>	<p>rectangular planning areas of approximately 80 acres; minimum access spacing at 350' or 500'; internal pedestrian circulation and vehicular required with marked/signalized crossings; location best for park and ride or timed-transfer center</p>

Figure 14. Urban Design Templates for Planning Areas.

Design Elements

Integration of land use and transportation through urban design establishes the parameter or equation that brings together a host of variables. Standard transportation scoping considerations provide the organizational structure. Urban design considerations regarding the quality of the experience and the visual impact are added to the specifics that address curb to curb, right of way, access management, view shed, and connections. This combination suggests the need for a new set of design criteria—or performance standards—that attends to activity and movement.

Five elements have been identified in this study. Each is described and discussed separately. A general description is given first and is followed with implications for activity and movement. The elements are organized to start at the most comprehensive scale—community connections—and conclude at the most constrained—curb to curb. Using this order suggests that community connections set the larger design paradigm and needs within the roadway curbs support that comprehensive goal.

Design Element: Community Connections

Community connections establish the basic points of change in movement direction and/or mode. They include a range of intersections such as junctions of expressways, boulevards or avenues and mid-block crossings between blocks. Adequate public road connectivity is necessary to reduce the intensity of cross and turning traffic at any single point in the system. Connectivity requires planning to occur at the network level and to consider the larger issues of where through traffic is given priority over direct access to land use. In the suburban environment, such high speed/high volume trips are usually carried on freeways, which diminishes the need to have higher speed expressways and provides the opportunity to use more multi-function arterials at slower speeds.

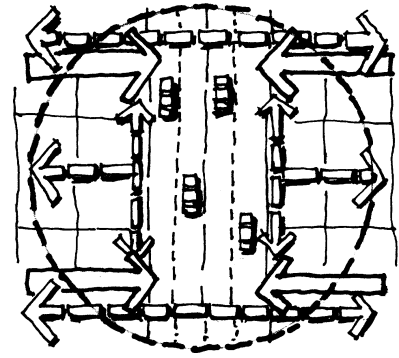

Activity

From an urban design viewpoint, community connection gives rise to centers of activity. The type, intensity and location of that activity is intimately linked to the nature of the road.

In town/neighborhood centers, the road is as much a part of the activity as the buildings and the people on it. The pedestrian must be able to see into buildings and small parks from across the street and feel comfortable interacting with and crossing the road. Buildings should be constructed close to the sidewalks that are wide enough for people to walk side-by-side or to push carts and strollers. This type of atmosphere encourages neighbors to stop for conversation; it encourages the shoppers to enter stores; and it allows the driver to slow down, search for on-street parking, and join the activity.

Town centers thrive around roads that support the businesses and events that take place there. The road must be able to support multi-modal transportation that brings people from adjacent neighborhoods or nearby communities. Since town center activity can take place along the road or it can be internally oriented to the site, it is critical that the road provide visual access for the driver and friendly sidewalks and crossings for pedestrians. The mixed use nature of the town center also requires a clear hierarchy of movement that is readily understood when approaching from the road and when walking through and around the town.

Subregional centers thrive around roads that focus on delivery: workers, goods, visitors, or customers. Activity is set back from the road and broken into smaller areas or rooms with inter-linked circulation systems. The arterial road serves as the framework for this subdivision so it must be legible, provide visual access to the rooms, and clearly define areas for pedestrian circulation.

Movement

From a roadway standpoint, community connections emphasize uniform spacing and signalization of public road intersections and provide for unsignalized intersections to occur at one-half the spacing of signalized intersections. The uniform spacing is a function of roadway speed with wider spacing for higher speed roads. The combination of the two elements establishes the block/grid dimensions that create basic planning areas.

Allowance for an unsignalized intersection at one-half the spacing of signalized intersections provides for development of an orderly public street network that will benefit the overall arterial system following ways:

- A denser network of intersecting streets will disperse traffic (crossing, entering, and exiting) over a larger number of points. Dispersing traffic reduces the amount of green signal time needed at any single intersection to serve those movements and can minimize the need for dual turn lanes (and their dedicated signal phases) by dispersing turning traffic over more points.
- Allowing public street access via unsignalized intersections potentially minimizes the number of direct access points onto a roadway by giving land parcels alternate access routes and reduces the amount of circuitous travel required for use of alternate access.

Unsignalized (two-way stop) control at the intermediate intersections is used to create a framework that emphasizes access at signalized intersections. Depending upon traffic volume conditions, the unsignalized intersections, particularly on the higher speed roadways, may be signalized over time in response to traffic safety needs.

Design Element: View Shed

The view shed is the driver's "field of vision"—a perceived space of movement flow for vehicles and other modes of transportation. How the physical environment of surrounding land uses is designed such as the siting of buildings, setting the proper corner radius and placement of planted forms, will define the view shed for the driver.

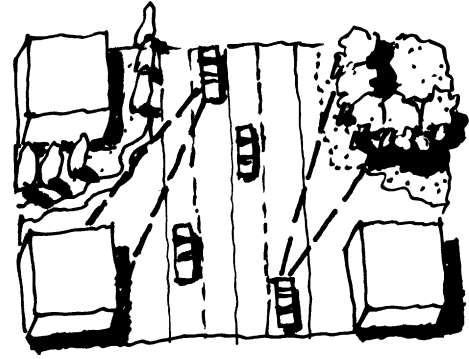

Activity

Urban design criteria can be used to shape development so it reinforces the movement flow, clarify circulation flow and to support multi-modal transportation within mixed-use development. From the viewpoint of the resident living or merchant working along the roadway, a quality view shed is critical to establishing the basic sense of economic, social and environmental health; safety; and welfare in the places along the roadway. The perceived sense of climate, noise and intensity of the roadway can be caused by a roadway where the roadway design and adjacent land uses are ill fitting and disconnected. Integrating the view sheds of both movement and activity will:

- Improve a driver's "anticipated expectation" of needed movement. In other words, the driver will better understand the intensity of traffic movement patterns and immediacy of interactions with land use activity.
- Improve drivers' legibility of the roadway network, improving their ability to anticipate and read oncoming intersections and access points to connecting roadways, other transportation mode access point and the type of neighboring land use activity.
- Improve the quality of vehicular and transit trip.
- Be more conducive to a wider range of mixed land uses, such as housing and more intense pedestrian commercial activity development.

Movement

In roadway design, the driver's view shed is closely linked to the amount of decision making a driver is required to do. Placement of signs that direct or control traffic and design of the messages on those signs is closely controlled to ensure that drivers can see, read, and interpret those messages at an appropriate up-stream distance to allow them sufficient time to make decisions about turning, slowing, or stopping. The speed limit of the roadway is an important factor in the design of the view shed since the speed of a vehicle directly affects the amount of distance a vehicle covers while a driver is making a decision. Thus, higher speed roadways have more space between signs, use larger fonts, and have shorter messages than are found on slower speed roadways. While a great amount of effort is focused on designing messages for drivers within the right of way, little to no attention is paid to density of messages that attract the driver's attention outside the right of way. The movement criteria for view shed is to extend the concepts used for conveying roadway messages to drivers to the land uses adjacent to the roadway to three dimensionally reinforce the roadway through building and landscape massing, siting and visual character.

Design Element: Access Management

Access management focuses on the basic driveway curb cuts that are “turning” points to individual land uses. These basic turning points have a fundamental impact upon roadway speed, character of arterial flow, as well as the viability of adjacent land uses. These turning points change over time as the nature of roadway and land uses change to accommodate new movement and activity patterns. For example, as county roads evolve into multi-function suburban arterial streets, roadway engineers, city planners and property owners will have to address the safety, number, location and function of driveways as their compatibility to future arterial and land use demands. In many cases traffic congestion is generated by outdated access points serving higher than planned traffic volumes, numerous individual residential driveways exiting on a busy arterial, or poorly marked and ill-defined access turning points.

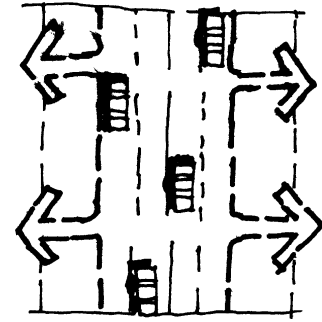

Activity

From an urban design perspective, access management organizes the physical structure of property in the following ways.

- First, these turning points dictate the basic interior circulation network and activity pattern and physical siting of buildings within the development area.
- Second, they define the spatial transition or threshold between the two intersecting movement systems of roadway and development area. They provide visual cues to allow approaching motorists to anticipate pedestrian activity and unexpected stopped vehicles.
- Third, they help channel pedestrian crossing from one block to another.

Movement

From a roadway design perspective, access management focuses on minimum driveway spacing. This spacing is dependent upon roadway intersection spacing, since driveways are first located in relation to intersections. Intersection spacing is a function of roadway speed and traffic signal operation (see Community Connections). Optimum signal spacing 1/4, 1/2, and 1 miles has been derived from a two-way balanced progression model for various combinations of signal cycle length and roadway speed. This approach uses a geometric model derived from time-space diagrams to generate a single-alternate timing pattern that provides for the same amount of time for progression through subsequent signals in either direction.

For driveways, minimum spacing is based on stopping sight distance, which is the minimum distance needed for a vehicle to stop without striking an object. In turn, stopping sight distance is based on roadway speed limit as shown in the following table:

Speed Limit	Stopping Sight Distance
30 mph	200 feet
35 mph	250 feet
40 mph	300 feet
45 mph	375 feet
50 mph	425 feet
55 mph	500 feet

Safe design of access points must take precedence over access spacing. Specific conditions, particularly above 40 mph, may require more separation between driveways than the minimums used as the basis for this pattern language. Other factors that influence the location of driveways are the presence or absence of medians, turn lanes, and accel/decel lanes and the amount of traffic on a roadway. Current practice tends to discourage driveways on roadways with speed limits above 40 mph to minimize the hazard potential on those roadways. This practice reemphasizes the need for interior circulation networks on properties adjacent to higher speed roads.

Design Element: Right of Way

The right of way is the overall setting in which people experience the character and use of a roadway. It is composed of the curb to curb roadway, pedestrian and adjacent land-use realms. The roadway and parallel pedestrian realms usually occupy the public street right of way. In place of the pedestrian realm of sidewalk and/or pathway, the right of way may include an open drainage swale and/or an open land buffer zone to the adjacent land uses. Getting the right of way sized properly to support automobile, transit, pedestrian movement systems and active mixed-use development is a critical issue as county roads evolve into multi-function suburban arterial streets.

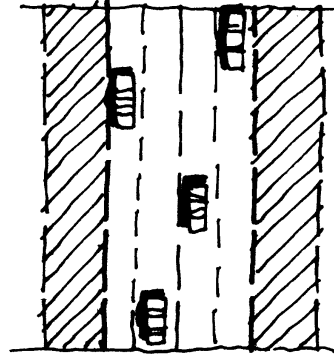

Activity

Having excessive right of way that is underdeveloped and minimally maintained raises detrimental urban design effects.

- It reduces the amount of land and quality of development options that the public and private sector has in “land locked” communities to accommodate changing economic demands and social demographic needs. These areas along arterial corridors are the only large places in fully-developed suburban communities that can be used for new development that meets changing needs.
- As a suburban community matures and socially diversifies, pedestrian activity increases. Wide rights of way and their companion sprawling intersections make for uninviting pedestrian crossings. They do not easily accommodate the development of transit stops and multi-modal interfaces.
- Excessive right of way produces a negative environmental image and place in the heart of a community, through a neighborhood of the community, or in the midst of an environmental habitat.

When road rights of way are excessive, neighboring development tends to move away from the arterial roadway often locating parking between the roadway and neighboring buildings. Reducing excess right of way where appropriate will reduce the need for frontage roads by encouraging development to move closer to the arterial roadway curb and rely upon collector streets to service the site.

Movement

The right of way has to be sufficiently wide to provide space for the following elements:

- Sidewalks or multi-use (pedestrian/bicycle) paths
- Roadway drainage
- Roadway shoulders
- Clear zones for vehicle recovery
- Mounting of signage for driveways
- Potential expansion of the roadway (adding lanes over time)

The amount of space dedicated to these elements will vary by roadway type. Clear zones can be as narrow as 18 inches in urban areas and as wide as eight feet in higher speed rural conditions. Similarly, shoulders/drainage can be as narrow as a curb and gutter in urban conditions and as wide as 20 or more feet when shoulders and drainage swales are used. The width of sidewalks and paths varies in relation to the demand for the facilities and their interaction with neighboring land uses. Space reserved for future travel lanes needs to be clearly delineated so that neighboring land uses address it appropriately.

Design Element: Curb to Curb

The curb to curb element is composed of the vehicle travel lanes, bicycle lanes, medians, intersections and other attributes devoted to vehicle movement and provides for a balanced transportation system that fully integrates automobile, public transportation, bicycle, pedestrian and freight needs.

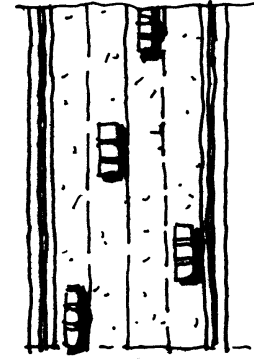

Activity

Like setting the boundary of any community place, establishing the curb to curb dimensions defines the basic spatial framework for these movement corridors and their ability to aggregate with neighboring activities and movement networks. The number of lanes and their lateral dimensions have a direct impact upon the environmental quality and spatial legibility of the roadway and neighboring property. Greater numbers of lanes tend to decrease the utility of at-grade pedestrian crossings at intersections, which limits the ability to attract mixed-use land use and pedestrian activity.

Selecting the proper lane width dimension for lower speed roads can decrease noise and reduce negative visual impact. Wider lanes condone drivers' tendencies to exceed the speed limit, which decreases the pedestrian's sense of security and safety. Increased speed also increases noise levels, which tends to eliminate housing and pedestrian intensive uses as suitable neighboring land uses.

In many fully-developed suburban communities, an arterial might be an older rural county road section—the edge is not a curb, but a roadway shoulder and a drainage swale. Some residents see this rural cross-section as symbolic of their rural lifestyle and view construction of curb and sidewalk as an urban invasion of their privacy. But as traffic increases on these segments, this perceived rural atmosphere diminishes. Adding a curb can increase a driver's sense of security and legibility of movement as well as provide a stronger indication of the line between public and private places. Drivers can see the roadway more clearly when moving at higher speeds and with increased congestion. This legibility provides the driver with a clearer set of anticipated expectations as to the proper speed and expected movement patterns. The edge can be developed into a full range of public and private spaces for a wide range of land use activities and environment. Examples include:

- Provide a curb to allow for a wide range of sidewalk corridor options and for more visible transit stops
- Widen the shoulder into a community pathway
- Enhance the drainage swale into a segment component of a larger community ecological water management and habitat open space system.

Movement

Design of the curb to curb roadway should minimize traffic hazards and emphasize safe travel for all modes. The following criteria address the number of lanes, as well as the width and use of the roadway:

- | | |
|---|---|
| <ul style="list-style-type: none"> • Number of Lanes | Operational requirement that is a function of the anticipated throughput or carrying capacity of the roadway; requirements for separate turning lanes will also be a function of traffic operations. Level of Service D is the general design criteria for establishing the number of lanes |
| <ul style="list-style-type: none"> • Lane widths • Intersection corner radii | A function of design speed; narrower lanes and shorter corner radii are generally used on lower speed roadways |
| <ul style="list-style-type: none"> • The type of median • The type of curb or road edge | A function of road type and design speed; faster roadways intended for longer distance movement will use medians and shoulders; curbs will be used in urban conditions with slower speeds; medians can also be used to create slower speed parkways |
| <ul style="list-style-type: none"> • Provisions for curb parking • Provisions for bicycle lanes • Provisions for transit stops (bus bulbs, bus bays) | Generally a function of mode and community character; higher design speeds will preclude curb parking and on-street transit stops and will require separation for on-street bicycle lanes |

Arterial Roadway Prototypes

Each roadway type was developed using the specified design standards as illustrated in cross section. Four-lane cross sections were developed for each prototype. Lane widths and edge treatments (parking, sidewalks, trails) were varied according to the design criteria and result in slightly different roadway characteristics among the three types. The roadways illustrate the differences in modal accommodation as bicycle and pedestrian activity moves further from the centerline as speed increases. Transit accommodation would similarly change, but is not readily visible in section. The numerical values used were held constant across the three prototypes to facilitate initial comparison of capacity and performance. In general, a range of lane widths and other dimensions are available within the prototypes. The Town Center Avenue would likely have narrower lane widths to facilitate pedestrian activity and the Subregional Expressway would likely have wider lane widths to facilitate higher speed travel.

Roadway Prototype: 35 mph, Town Center Avenue



Figure 15. Local example: Hennepin Avenue, Minneapolis, Minnesota.

Section Layout

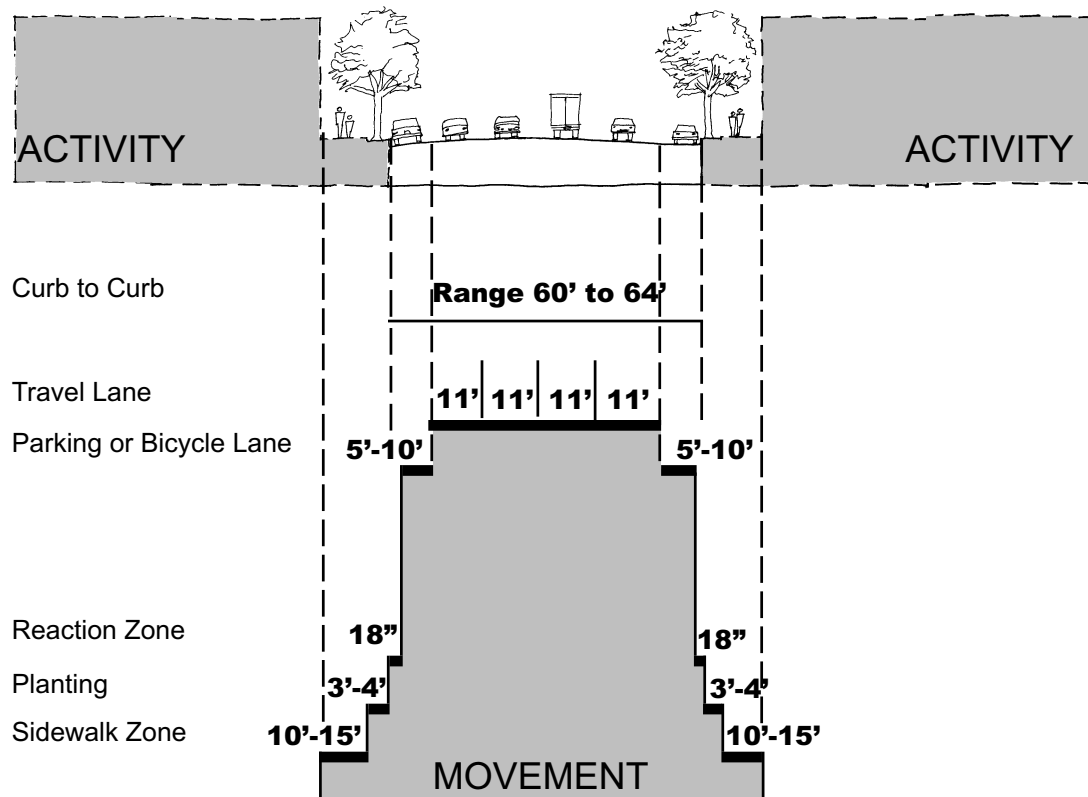

Figure 16. Town Center Avenue Section Layout.

Roadway Prototype: 45 mph, Community Boulevard



Figure 17. Local example: Excelsior Boulevard, St. Louis Park, Minnesota.

Section Layout

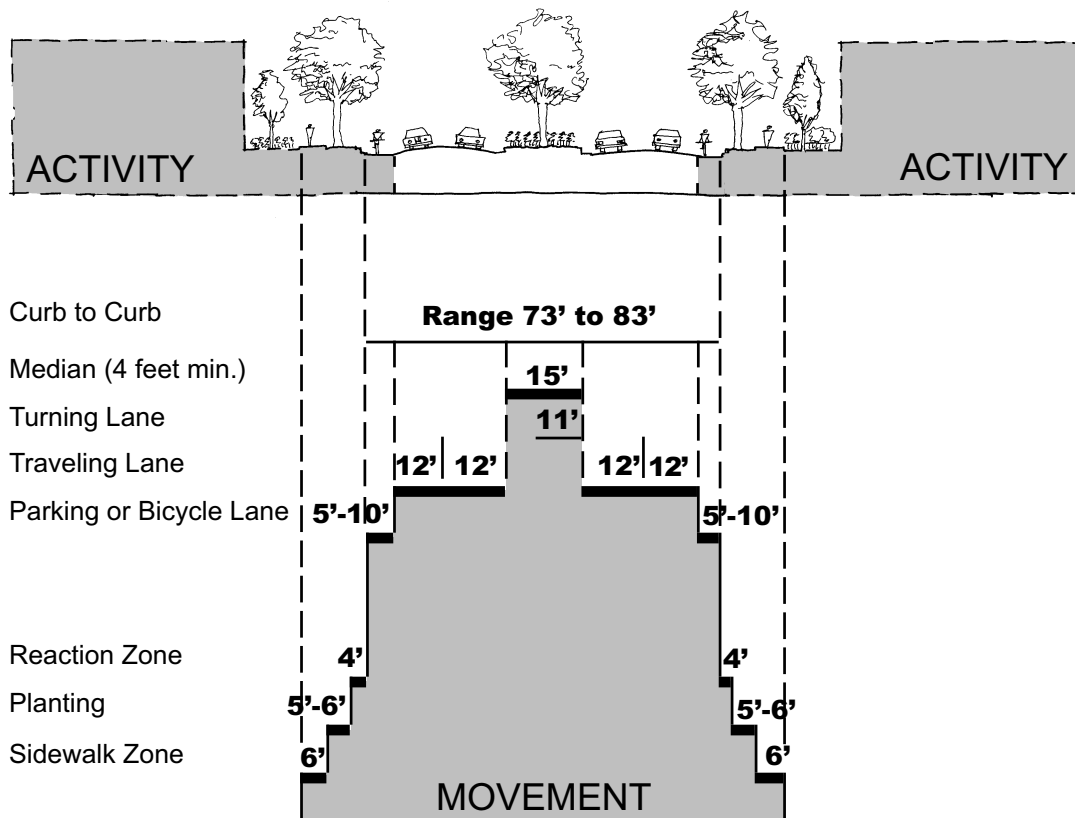

Figure 18. Community Boulevard Section Layout.

Roadway Prototype: 55 mph, Subregional Expressway



Figure 19. Local example: Ramsey County Highway 96, Shoreview, Minnesota.

Section Layout

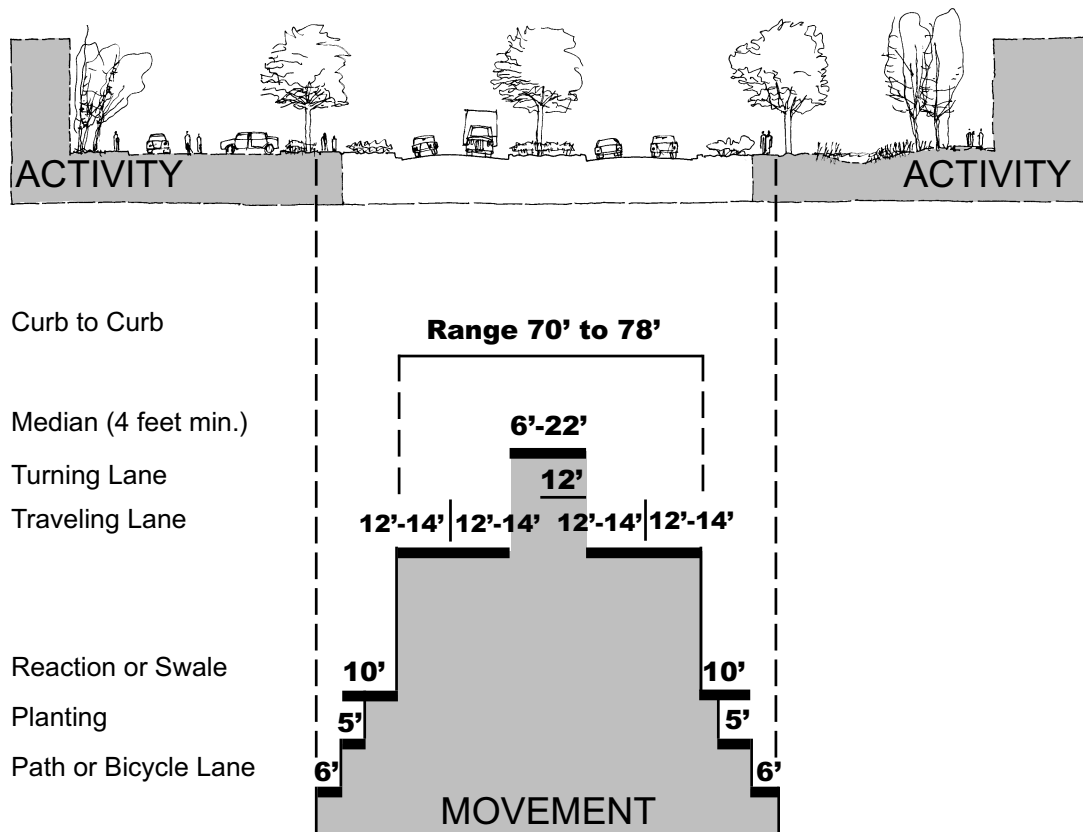

Figure 20. Subregional Expressway Section Layout.

Connection Spacing

Minimum connection spacing has been developed on the basis of signal progression and stopping sight distance to provide for a pattern of 1/4, 1/2 and 1-mile spacing of signalized intersections. Unsignalized intersections occur on one-half the spacing of signalized intersections. Driveway spacing is controlled by stopping sight distance and translates to 250 feet at 35 m.p.h., 350 feet at 45 m.p.h., and 500 feet at 55 m.p.h. This establishes a pattern of access that provides for a doubling of values between each of the three roadway types and sets up an armature of block sizes that frame the urban design elements.

Operating Characteristics of Connection Spacing

Evaluation of the characteristics of the three roadway prototypes has been conducted using highway capacity methods and simulation modeling. Networks were set up with turning movements at each of the intersections and driveways. Signal timings were prepared and optimized for each of the three travel speeds and used to test the effectiveness of the roadway prototype. Traffic volumes were held constant among the three conditions to determine the relative effect of traffic throughput and congestion in relation to speed. The following table shows the results of the analyses. The network is arranged such that the east-west direction represents the arterial and the north and south directions are cross streets.

In operational terms, each of the designs is shown to be able to accommodate the same amount of traffic at essentially the same Level of Service. Variations in delay for various movements at individual intersections are present among the prototypes and are generally a function of changes in signal timing and left turn treatments. These changes are required by changes in operating philosophy that are speed linked (permissive turns are allowable at lower speeds, but not at higher speeds) and change the amount of green time available for through movements. Overall, the striking difference between the prototypes is the speed of through vehicles in the network. There is roughly a ten mph difference in speed between each type of roadway, which says that the more closely spaced the signals are in the system, the lower the likely speed of through vehicles. However, even with the lower through speeds, the Town Center Avenues have equivalent throughput and operational capacity as the other prototypes, which means that mixing the prototypes along a roadway, given sufficient length of each segment, will not necessarily result in a reduced capacity or bottleneck condition. The differences in through travel speeds suggest that adequate treatment of the transition zones between segments will be extremely important.

Intersection	Approach	Sub-Regional Expressway				Community Boulevard				Town Center Avenue			
		Signals 1/2 mile; Posted 55mph		Signals 1/4 mile; Posted 45 mph		Signals 1/4th mile; Posted 35mph		Signals 1/4th mile; Posted 35mph		Signals 1/4th mile; Posted 35mph		Signals 1/4th mile; Posted 35mph	
		Approach	Intersection	Approach	Intersection	Approach	Intersection	Approach	Intersection	Approach	Intersection	Approach	Intersection
		Delay	LOS	Delay	LOS	Delay	LOS	Delay	LOS	Delay	LOS	Delay	LOS
1	N	41.3	E	13.9	B	45.3	E	12.5	B	29.5	D	14.4	B
	E	8.9	B			9.0	B			16.4	C		
	S	37.0	D			38.5	D			25.8	D		
	W	12.9	B			9.5	B			10.2	B		
2	N	36.8	D	22.7	C	39.6	D	21.0	C	29.6	D	16.1	C
	E	19.3	C			12.5	B			15.2	C		
	S	37.0	D			38.1	D			30.9	D		
	W	17.2	C			17.4	C			8.7	B		
3	N	37.4	D	22.0	C	34.3	D	22.5	C	28.5	D	15.9	C
	E	14.2	B			16.1	C			6.6	B		
	S	35.1	D			31.6	D			32.6	D		
	W	20.1	C			21.6	C			14.6	B		
4	N	31.6	D	19.6	C	28.2	D	21.1	C	21.0	C	14.5	B
	E	20.0	C			23.0	C			17.0	C		
	S	38.3	D			47.4	E			19.8	C		
	W	14.8	B			16.2	C			10.6	B		

Through Vehicle Speed										
	EB		42	mph		33	mph		24	mph
	WB		42	mph		32	mph		24	mph

Table1. Operating Characteristics of Roadway Prototypes.

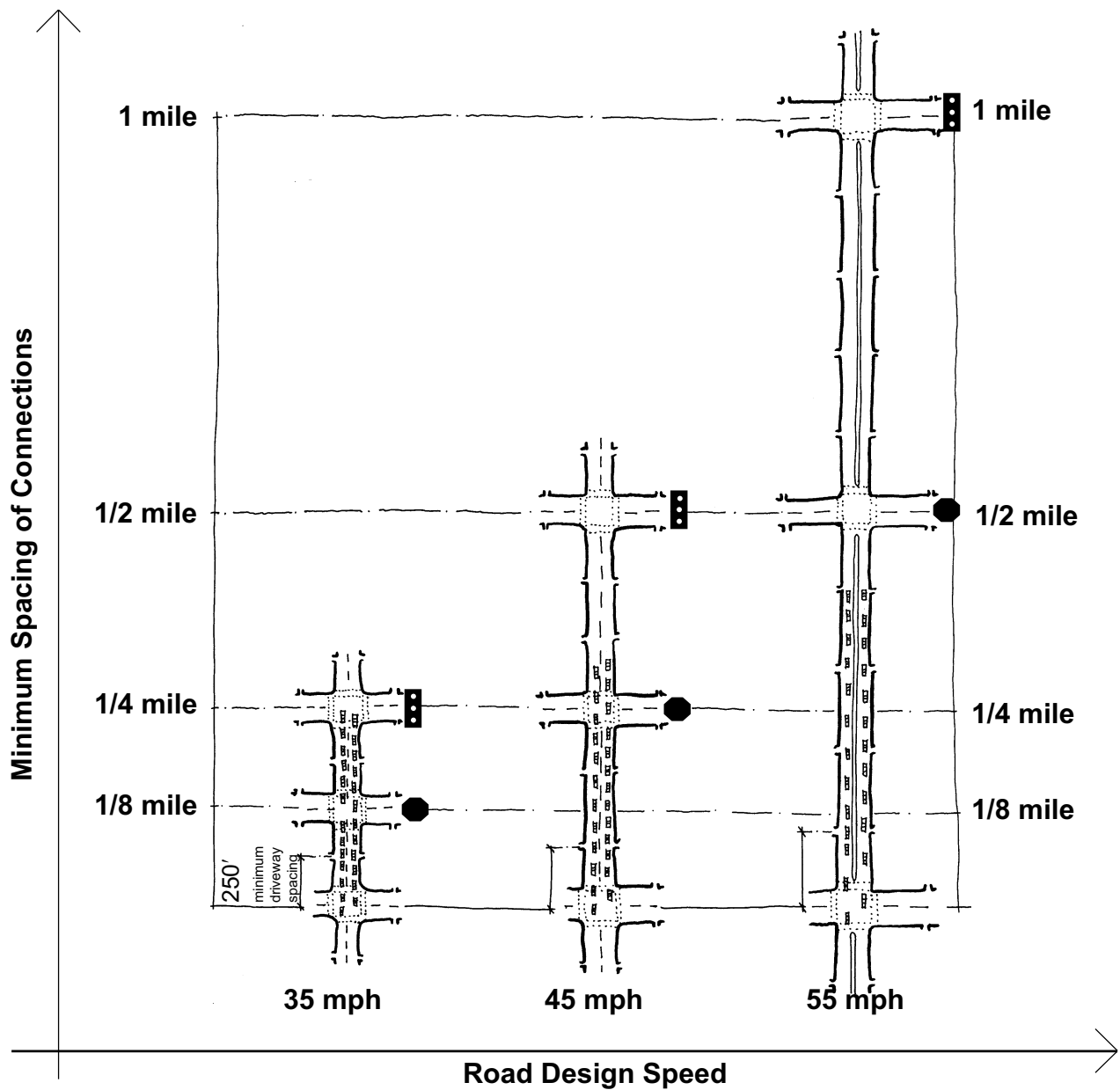

Figure 21. Road Design Speed and Access Management Chart.

Urban Design Templates

While the roadway prototypes can be classed into three, the urban design prototypes have more dimensions to be considered thus requiring more than three templates. The activity patterns illustrate that the criteria for the urban design needs to consider the relationship to the street or streets, the arrangement and/or need for internal circulation, and the general placement of the building on the site. Not all building types are suitable for all land uses. Hence, different building/site patterns will result for different land uses (i.e., employment vs. residential and mixed-use vs. single use).

Template Description

The minimum connection spacing defines block dimensions, both along the arterial and at intersections. Where arterials cross, the connection spacing establishes a development armature that fits into one of nine possible block grids with the maximum dimensions being drawn from the connection spacing (see opposite page). As these basic block grids are evaluated for movement patterns that reflect minimum driveway spacing, activity patterns become apparent and suggest the underlying criteria for urban design with regard to building orientation, street access, and internal circulation.

From Templates to Livable Community Places

Each template yields a “livable community place” when it is overlaid on an intersection. When these places work in concert across a subregion or reach, they function as a movement and activity network.

The movement and activity of these places can be detailed further using the design elements as the organizing structure. On the following pages, appropriate land uses, activity levels, and design dimensions are assigned to each type of place created by the template. The urban design qualities of each place, and how each place can serve as a network building block are described for each template.

Templates are drawn to the same scale and organized from the slowest road design speed to the highest. Six templates, rather than nine, are described because there are six variations on two basic patterns: an intersection of two roads of the same design speed (i.e., 35/35 m.p.h., 45/45 m.p.h., and 55/55 m.p.h.) which creates square planning areas; and an intersection of two roads with unequal road design speeds (i.e., 35/45 m.p.h., 35/55 m.p.h., and 45/55 m.p.h.) which creates rectangular planning areas.

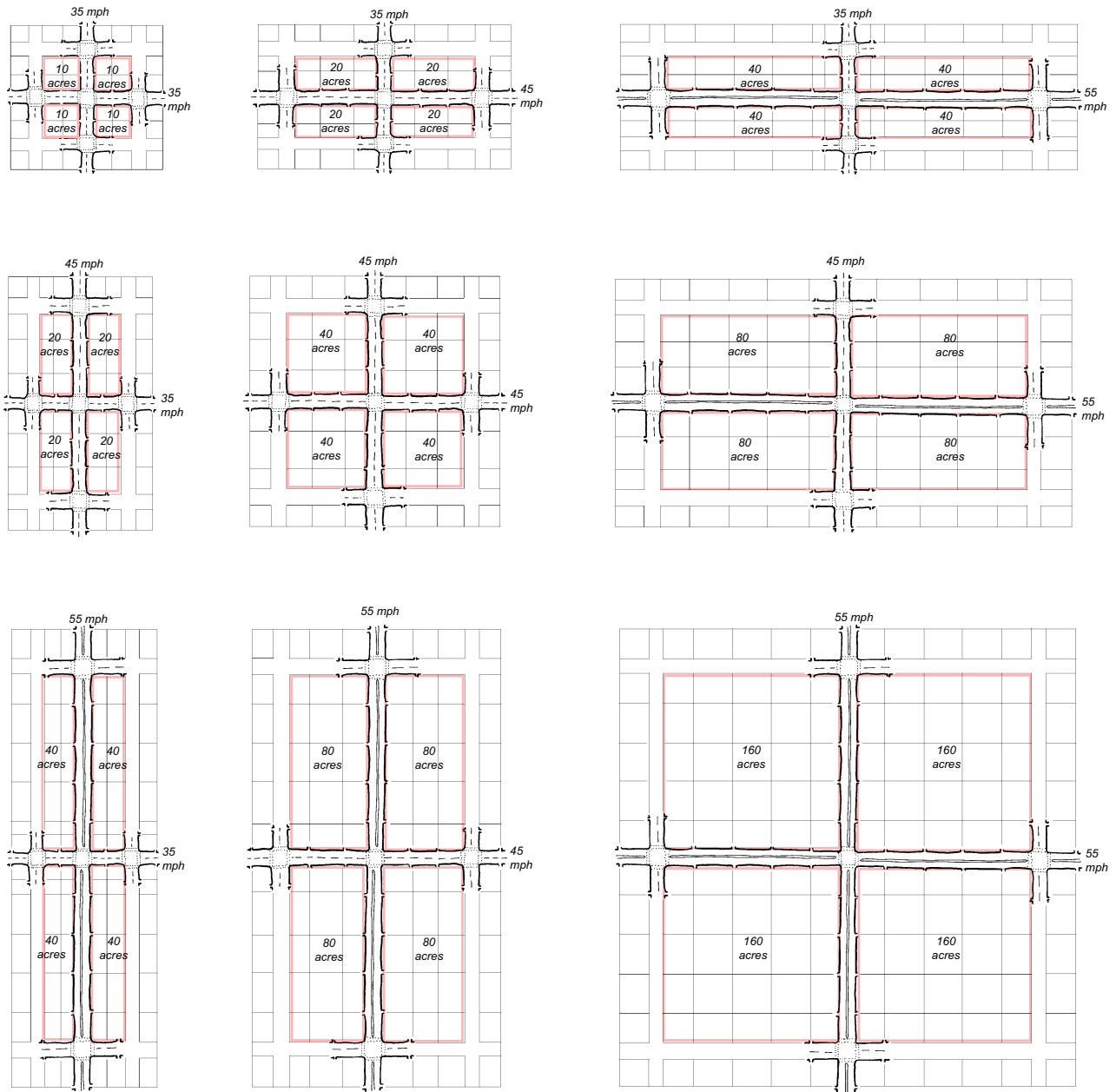
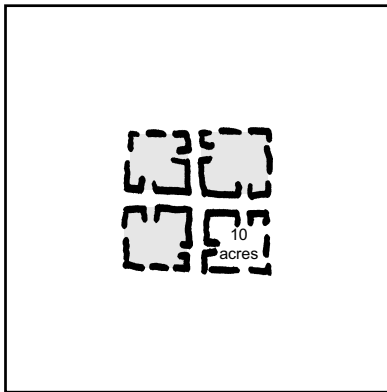

Figure 22. Urban Design Templates for Suburban Arterial Intersections.

Urban Design Template for 35/35 mph Intersection



Planning Area

Square development areas of approximately 10 acres; minimum access spacing between access points is 250'; active corner and mid-block pedestrian crossings; location best for transit stops.

Curb to Curb

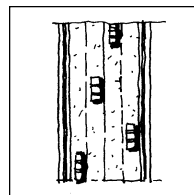
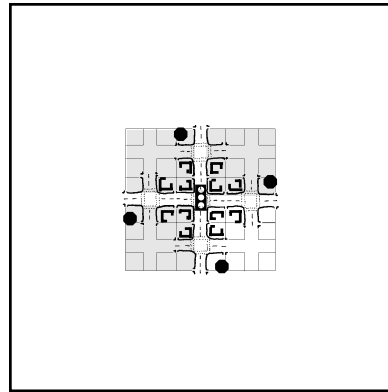

Right of Way

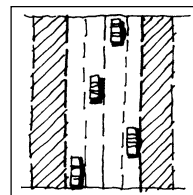
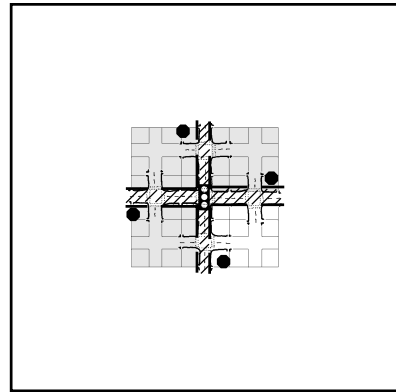

Livable Community Place

This place is best for a neighborhood or town center with activity and movement patterns suitable for transit oriented development—serving bus or light rail transit stops. The full site is within a 1/4 mile or 5 minute walking distance of a central transit stop. This is a heavy pedestrian district with mixed-use commercial, office and housing buildings fronting sidewalks. It is an active 12-hour place of business and services during the day and neighborhood entertainment in the evening.

35
mph

CSAH/MSA Design Standards

Urban cross-section (curb/gutter)
Travel lanes: 11 feet
Turn lanes: 10 feet
Parking lanes: 8-10 feet

Median width: 4 feet (min.)

Transit: frequent stops; local routes; may extend into the parking lane with curb extensions

Pedestrian: sidewalks adjacent to road; crossings at intersections

Bicycle: part of traffic stream

Parking: on-street, parallel to curb; may consider use of tandem stalls with curb extensions for planting or walk

Pedestrian: walks adjacent to road; crossings at intersections

Sidewalks: 10-15 feet

Planting strip: 3-4 feet (nominally in sidewalk or parking)

Reaction distance: 18 inches (min.); 2 feet preferred (nominally in parking)

Streetscape: curb/sidewalk

Lighting: pedestrian scale

Buildings: build to site edge (code)

Transit stops: integrate into streetscape/sidewalk/planting if at curb; integrate into building if back from curb (arcade/canopy, seating and lighting)

Network Building Block

The neighborhood center is typically no larger than the four blocks surrounding the one intersection. The location of the neighborhood center should serve as a transit connection, a place for new in-fill housing and commercial and social services.

The town center is the larger version of this place. The town center should be at least two intersections in length serving at least eight blocks. The town center can be a mix of civic center, park, retail, or small office activities with mixed-income housing town homes.

Access Management

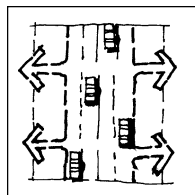
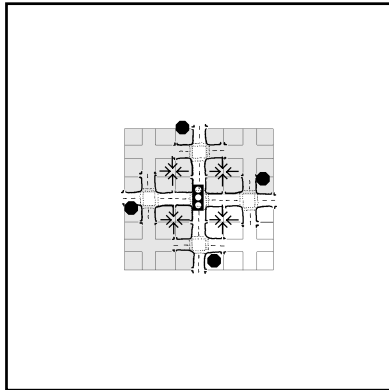

View Shed

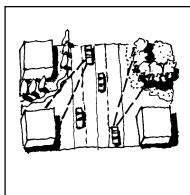
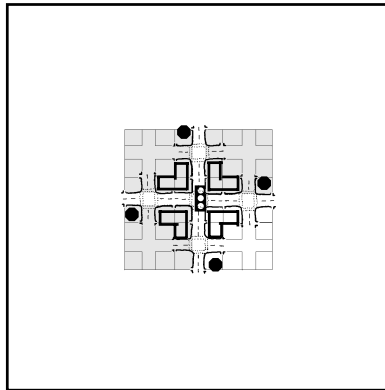

Community Connections

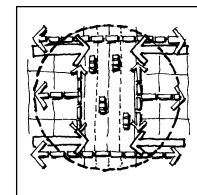
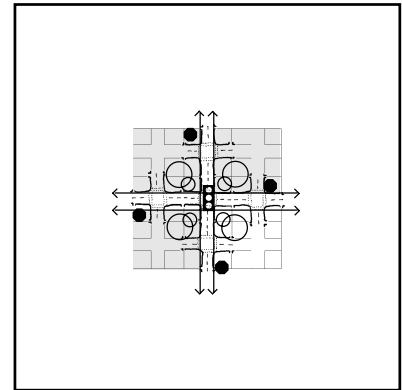

Median type: may be undivided

Some direct access

Driveways 250 feet apart

Mid-block access to parking

Mixed use buildings to support shared parking/ access

Consolidate on-site/off-street circulation on individual parcels if lot dimensions are narrower than access spacing (use cross-easements, shared drives, shared parking)

From the road, signage and placement of building should be visible at 30-40 mph speeds

Organize uses into mixed use places to support view from the buildings up to the street (integrated activity with multiple focus points)

Signage: on building fronts/awnings, pedestrian scale "sandwich board" signs on walks

Messages on buildings and scale of buildings oriented to slower speed traffic

Building orientation: main entrance oriented to arterial

Building transparency: high degree to contribute to pedestrian street life and communicate activity to motorist

Connectors between town centers and neighborhood centers

Circulation at town centers

Signalized intersections—1/4 mile

Unsignalized intersections—1/8 mile

Direct extension of pedestrian and transit focus for civic, cultural, religious and parks activity within 1/4 to 1/2 mile distance from center

Street function is to provide arterial movement, but to balance with pedestrian scale of the mixed use center

Urban Design Template for 45/45 mph Intersection

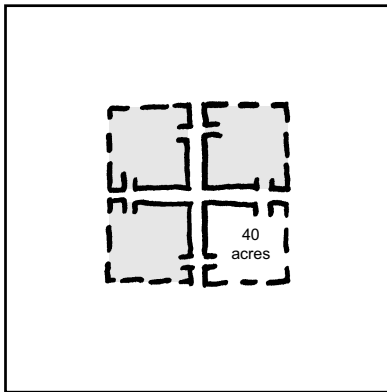

Planning Area

Square planning areas of approximately 40 acres; minimum access spacing at 350'; internal pedestrian circulation preferred with marked crossings; location best for timed-transfer transit center.

Curb to Curb

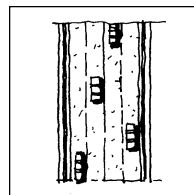
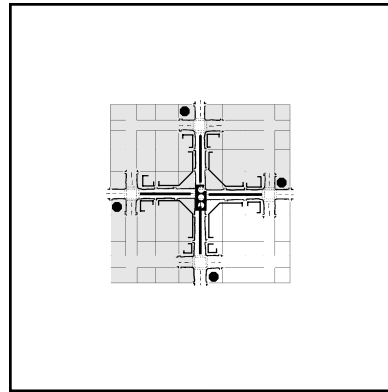

Right of Way

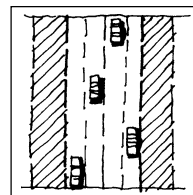
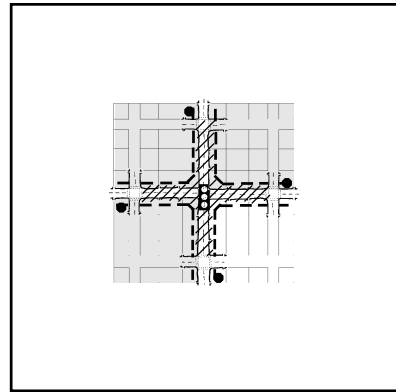

Livable Community Place

This place is best for a community center which might include a large civic center, community recreation center, restaurants, service retail, high tech office campus, new in-fill medium density town homes and a community open space. These centers depend heavily upon a network of pedestrian circulation and mixed-use buildings for easy access between uses and vital 12-hour activity. Also, this place is best for adding new office retail campus centers into and adjacent with existing residential neighborhoods.

Network Building Block

This place is best located adjacent to a regional highway or sub-regional expressway. Subregional and regional transit stops are best situated at the heart of these centers. Pedestrian connections between the center transit stop and surrounding neighborhoods is critical.

45
mph

CSAH/MSA Design Standards

Urban cross-section (curb/gutter) but may be rural cross-section (shoulders, drainage swale)
Travel lanes: 12 feet
Turn lanes: 11 feet

Median width: 4 feet (min.)

Transit: limited stops and express routes; some local routes

Pedestrian: detached paths/sidewalks adjacent to road; crossings at intersections

Bicycle: marked lanes, 4 feet (min.)

Parking: moves off-street and into the land use realm

Pedestrian: walks adjacent to road or detached paths; crossings at intersections

Sidewalks: 6 feet

Planting strip: 5-6 feet; between sidewalk/path and curb to buffer pedestrian from vehicle movement

Reaction distance: 4 feet

Transit stops: pulled back from intersection (to accommodate larger corner radii/right turn lanes); orient stops and enlarge waiting areas to accommodate transfers

Parking: off-street only

Streetscape: linear corridor configuration

Transit stops: freestanding elements that integrate into streetscape

Access Management

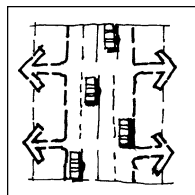
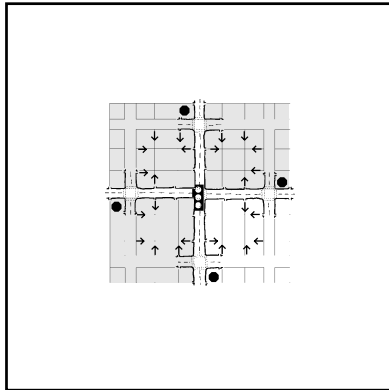

Median type: may be undivided; turn lanes necessary at most intersections

Limited direct access

Focus access at mid-block or onto lower speed cross street

Consolidate on-site/off-street circulation on individual parcels if lot dimensions are narrower than access spacing (use cross-easements, shared drives, shared parking)

View Shed

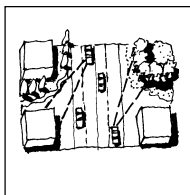
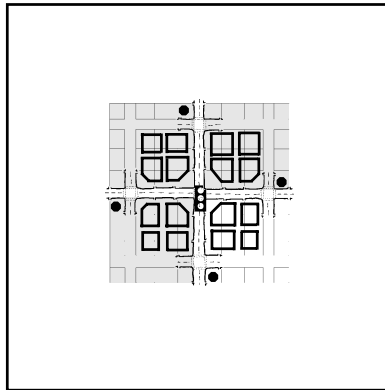

From the road, signage and placement of buildings should be visible at 40-45 mph speeds

Building orientation: main entrances at front and back to accommodate pedestrians and transit riders as well as drivers

Building transparency: high degree on arterial side to connect activities among planning areas and calm traffic

Community Connections

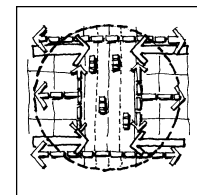
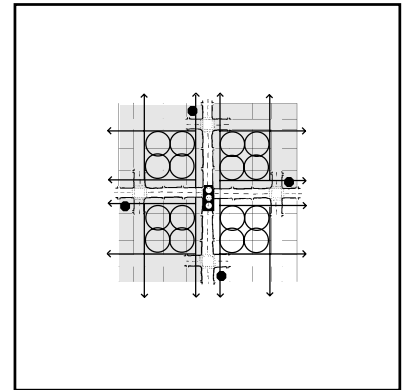

Commercial corridors at and between town centers

Signalized intersections—1/2 mile

Unsignalized intersections—1/4 mile

Street function is to provide arterial movement, but to balance with transit and linear corridor concepts

Urban Design Template for 55/55 mph Intersection

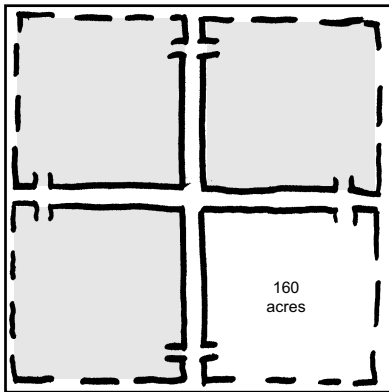

Planning Area

Square planning areas approximately 160 acres; minimum access spacing at 500'; internal pedestrian and vehicular circulation required; location best for park and ride or off-street transit hub.

Curb to Curb

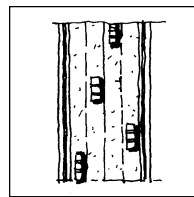
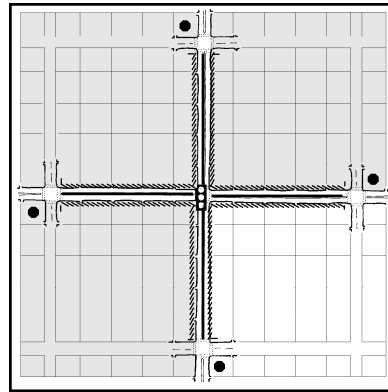

Right of Way

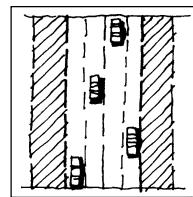
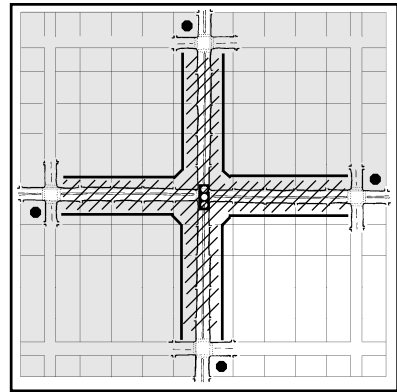

Livable Community Place

The intersection is designed to handle large volumes of high-speed auto and regional transit movement serving large internal development areas. These areas are similar to town and community centers in land use, function, and circulation network. They might include a regional mall, big box retail, light industrial and/or heavy high-tech uses. These places are best for regional transit hubs which are integrated into quadrant pedestrian networks and mixed-use buildings.

Expansive road rights of way and building landscapes should be designed as water management systems directing run-off to non-structural, natural wetland treatments and connecting to the community's open space system.

Network Building Block

Pedestrian connection between the development quadrants should be by pedestrian bridges. Pedestrian bridges make excellent landmarks, identify adjacent land use activity for the drivers on the expressway and provide safe passage for pedestrians.

55
mph

TH/CSAH Design Standards

Generally rural cross-section (shoulders and drainage swale)

Travel lanes: 12-14 feet

Turn lanes: 12 feet

Median width: 6-22 feet

Transit: express routes; hub to hub movement

Pedestrian: detached paths; minimal crossings

Bicycle: detached paths

Parking: off-street only

Pedestrian/Bicycle: detached paths; crossings at intersections or grade-separated

Sidewalks: 6 feet

Planting strip: 5 feet (nominally in reaction area)

Reaction Distance: 10 feet; may include drainage swale

Transit stops: move off-street into hubs or very widely spaces; bus bays (pullouts) may be appropriate at such stops

Parking: off-street only

Linear open space for water management

Access Management

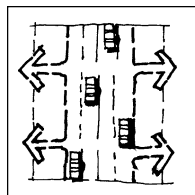
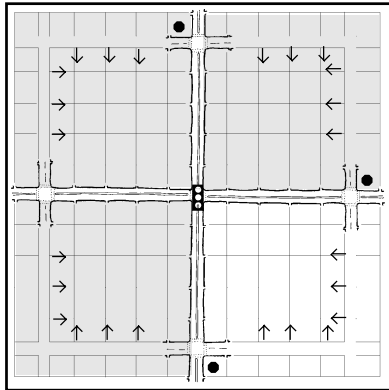

Median type: barrier (raised or depressed, planted); turn lanes necessary at intersections
Minimal direct access

Frontage roads may be used

Required well-developed internal circulation systems

View Shed

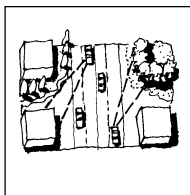
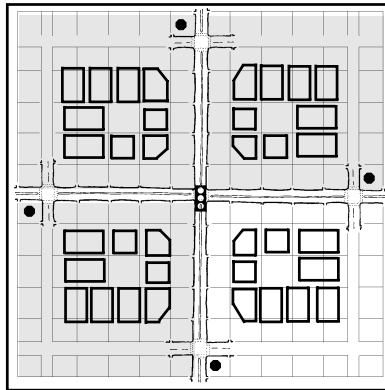

From the road, signage and placement of buildings should be visible at 50-55 mph speeds

Building orientation: may rotate off the arterial to encourage internal circulation; an internal main street could provide focal point for main facades of buildings

Building transparency: lower priority for sides facing arterials

Community Connections

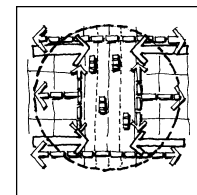
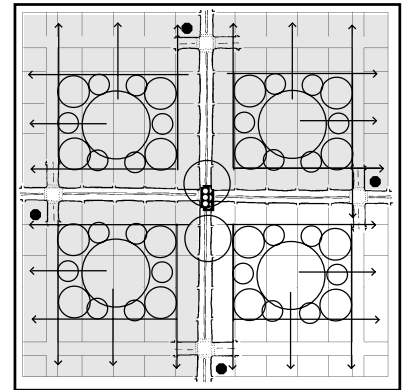

Connectors between centers

Signalized intersections—1 mile

Unsignalized intersections—1/2 mile

Street function prioritizes movement over access

At least one axis should connect directly into a regional highway; the other should decrease in section width as it enters into adjacent neighborhoods

Urban Design Template for 35/45 mph Intersection

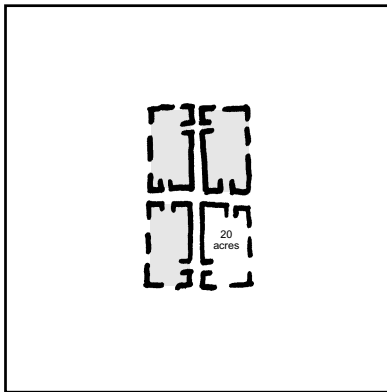

Planning Area

Rectangular planning areas of approximately 20 acres; minimum access spacing at 250' or 350'; pedestrian crossing at intersection; location best for transit stop/route transfer.

Curb to Curb

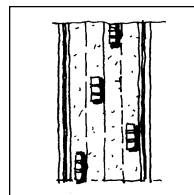
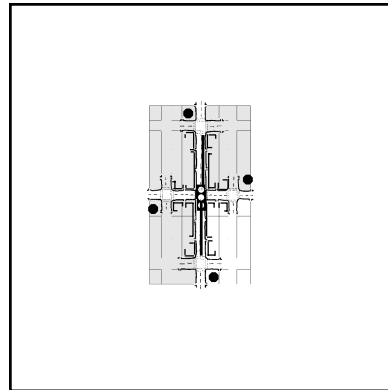

Right of Way

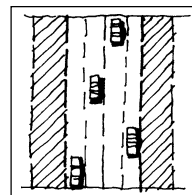
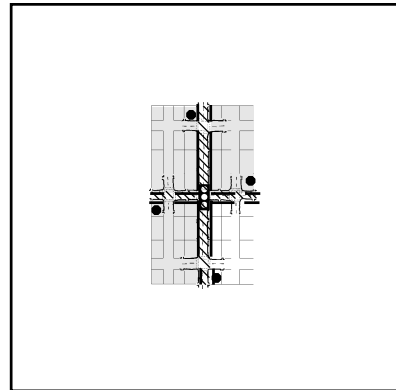

Livable Community Place

This place brings together the activity and movement assets of neighborhood and community centers. This is best used for a town center which includes a large amount of office and housing, such as high-tech office woven together with mixed income town homes, live-work housing and community natural systems.

Network Building Block

The 35 mph axis of the development area is best for transit, in-fill town homes, pedestrian sidewalks and land use connection to neighboring residential areas and/or community and sub-regional open space.

The 45 mph axis is best for the location of a office high-tech campus development and medium-density housing connected to surrounding residential areas.

The 45 mph axis can be designed as a landscaped parkway instead of a work and commerce area. The parkway might include renovated homes mixed with new in-fill townhomes.

35 mph

CSAH/MSA Design Standards

Urban cross-section (curb/gutter)
 Travel lanes: 11 feet
 Turn lanes: 10 feet
 Parking lanes: 8-10 feet
 Median width: 4 feet (min.)

Transit: frequent stops; local routes; may extend into the parking lane with curb extensions

Pedestrian: sidewalks adjacent to road; crossings at intersections

Bicycle: part of traffic stream

Parking: on-street, parallel to curb; may consider use of tandem stalls with curb extensions for planting or walk

Pedestrian: walks adjacent to road; crossings at intersections

Sidewalks: 10-15 feet

Planting strip: 3-4 feet (nominally in sidewalk or parking)

Reaction distance: 18 inches (min.); 2 feet preferred (nominally in parking)

Streetscape: curb/sidewalk

Lighting: pedestrian scale

Buildings: build to site edge (code)

Transit stops: integrate into streetscape/sidewalk/planting if at curb; integrate into building if back from curb (arcade/canopy, seating and lighting)

45 mph

CSAH/MSA Design Standards

Urban cross-section (curb/gutter) but may be rural cross-section (shoulders, drainage swale)
 Travel lanes: 12 feet
 Turn lanes: 11 feet
 Median width: 4 feet (min.)

Transit: limited stops and express routes; some local routes

Pedestrian: detached paths/sidewalks adjacent to road; crossings at intersections

Bicycle: marked lanes, 4 feet

Parking: moves off-street and into the land use realm

Pedestrian: walks adjacent to road or detached paths; crossings at intersections

Sidewalks: 6 feet

Planting strip: 5-6 feet; between sidewalk/path and curb to buffer pedestrian from vehicles

Reaction distance: 4 feet

Transit stops: pull back from intersection to accommodate larger corner radii/right turn lanes; orient stops/enlarge waiting areas to accommodate transfers

Parking: off-street only

Streetscape: linear configuration

Transit stops: freestanding, integrated into streetscape

Access Management

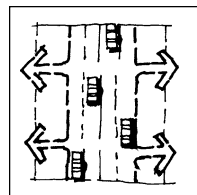
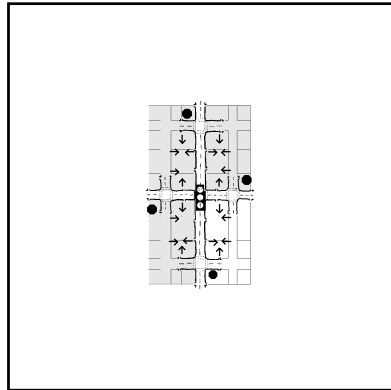

Median type: may be undivided

Some direct access

Driveways 250 feet apart
Mid-block access to parking

Mixed use buildings to support shared parking/
access

Consolidate on-site/off-street circulation on individual parcels if lot dimensions are narrower than access spacing (use cross-easements, shared drives, shared parking)

View Shed

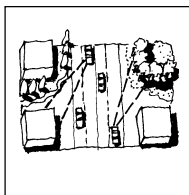
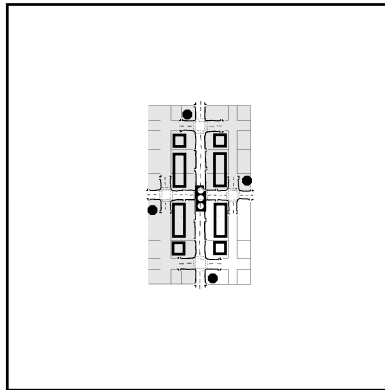

From the road, signage and placement of buildings should be visible at 30-40 mph speeds

Organize uses into mixed use places to support view from the buildings up to the street (integrated activity with multiple focus points)

Signage: on building fronts/awnings, pedestrian scale "sandwich board" signs on walks

Messages on buildings and scale of buildings oriented to slower speed traffic

Building orientation: 25 mph arterial best location for front door or toward local streets parallel to 45 mph arterial

Building transparency: high percentage desired along 35 mph arterial

Community Connections

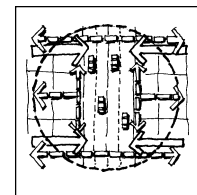
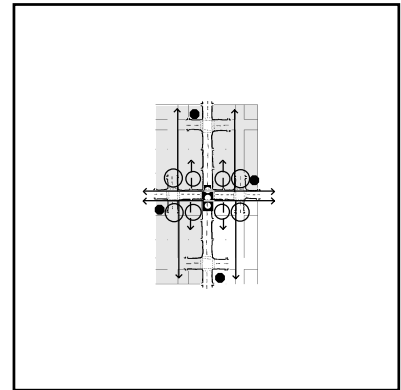

Connectors between town centers and neighborhood centers

Circulation at town centers

Signalized intersections—1/4 mile

Unsignalized intersections—1/8 mile

Direct extension of pedestrian and transit focus for civic, cultural, religious and parks activity within 1/4 to 1/2 mile distance from center

Street function is to provide arterial movement, but to balance with pedestrian scale of the mixed use center

Median type: may be undivided; turn lanes necessary at most intersections

Limited direct access

Focus access at mid-block or onto lower speed cross street

Consolidate on-site/off-street circulation on individual parcels if lot dimensions are narrower than access spacing (use cross-easements, shared drives, shared parking)

From the road, signage and placement of buildings should be visible at 40-45 mph speeds

Building orientation: main entrance away from 45 mph arterial; clearly marked pedestrian entrance needed

Building transparency: windows on side facing 45 mph arterial contribute to street life and calm traffic

Commercial corridors at and between town centers

Signalized intersections-1/2 mile

Unsignalized intersections-1/4 mile

Street function is to provide arterial movement, but to balance with transit and linear corridor concepts

Urban Design Template for 35/55 mph Intersection

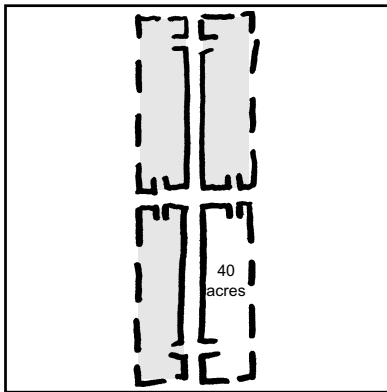

Planning Area

Rectangular planning areas of approximately 40 acres; minimum access spacing at 250' or 500'; pedestrian crossing minimal; internal pedestrian circulation required and internal vehicular circulation preferred; location best for transit park & ride

Curb to Curb

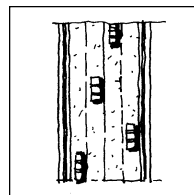
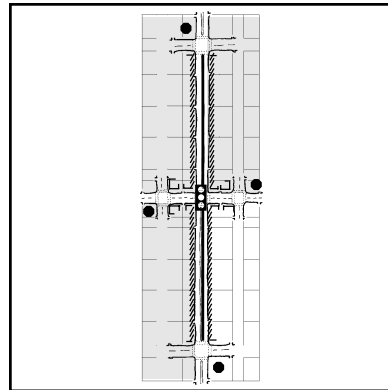

Right of Way

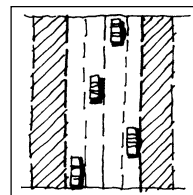
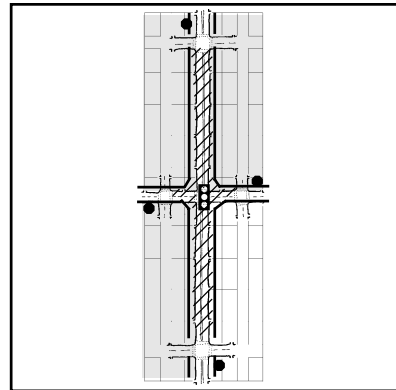

Livable Community Place

This intersection mixes the neighborhood center with a sub-regional expressway. This type of place is best designed as a combination subregional environmental parkway and neighborhood center and transit stop.

This place is best for replacing narrow obsolete commercial strips centers. The commercial activities can be consolidated into neighborhood centers. The older commercial land uses can be replaced with new in-fill town home neighborhood and natural systems, and parks integrated into surrounding residential areas.

35 mph

CSAH/MSA Design Standards

Urban cross-section (curb/gutter)
 Travel lanes: 11 feet
 Turn lanes: 10 feet
 Parking lanes: 8-10 feet

Median width: 4 feet (min.)

Transit: frequent stops; local routes; may extend into the parking lane with curb extensions

Pedestrian: sidewalks adjacent to road; crossings at intersections

Bicycle: part of traffic stream

Parking: on-street, parallel to curb; may consider use of tandem stalls with curb extensions for planting or walk

Pedestrian: walks adjacent to road; crossings at intersections

Sidewalks: 10-15 feet

Planting strip: 3-4 feet (nominally in sidewalk or parking)

Reaction distance: 18 inches (min.); 2 feet preferred (nominally in parking)

Streetscape: curb/sidewalk

Lighting: pedestrian scale

Buildings: build to site edge (code)

Transit stops: integrate into streetscape/sidewalk/planting if at curb; integrate into building if back from curb (arcade/canopy, seating and lighting)

Network Building Block

The 35 mph axis is best as a transit stop and connection to surrounding residential neighborhoods.

The 55 mph axis can be designed as a environmental natural system—a linear open space—integrating adjacent residential neighborhoods with the roadway.

55 mph

TH/CSAH Design Standards

Generally rural cross-section (shoulders and drainage swale)
 Travel lanes: 12-14 feet
 Turn lanes: 12 feet
 Median width: 6-22 feet

Transit: express routes; hub to hub movement

Pedestrian: detached paths; minimal crossings

Bicycle: detached paths

Parking: off-street only

Pedestrian/Bicycle: detached paths; crossings at intersections or grade-separated

Sidewalks: 6 feet

Planting strip: 5 feet (nominally in reaction area)

Reaction Distance: 10 feet; may include drainage swale

Transit stops: move off-street into hubs or very widely spaces; bus bays (pullouts) may be appropriate at such stops

Parking: off-street only

Linear open space for water management

Access Management

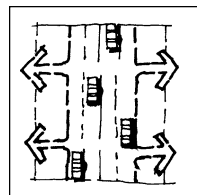
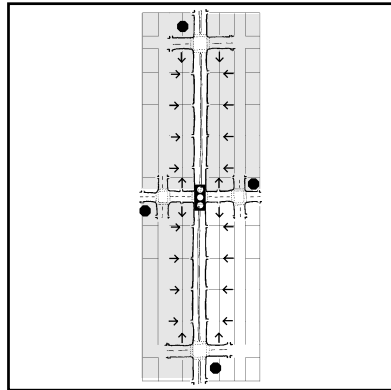

Median type: may be undivided

Some direct access

Driveways 250 feet apart

Mid-block access to parking

Mixed use buildings to support shared parking/ access

Consolidate on-site/off-street circulation on individual parcels if lot dimensions are narrower than access spacing (use cross-easements, shared drives, shared parking)

View Shed

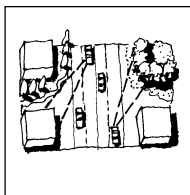
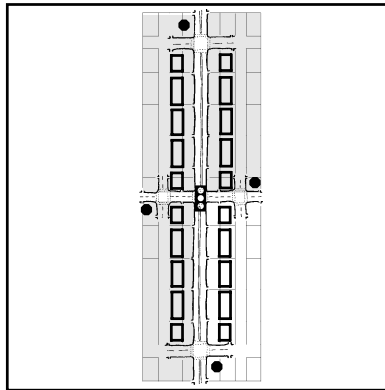

From the road, signage and placement of building should be visible at 30-40 mph speeds

Organize uses into mixed use places to support view from the buildings up to the street (integrated activity with multiple focus points)

Signage: on building fronts/awnings, pedestrian scale "sandwich board" signs on walks

Messages on buildings and scale of buildings oriented to slower speed traffic

Building orientation: main entrances should orient to local street parallel to 55 mph

Building transparency: higher transparency to alert drivers to change in environment

Community Connections

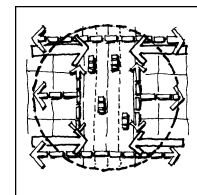
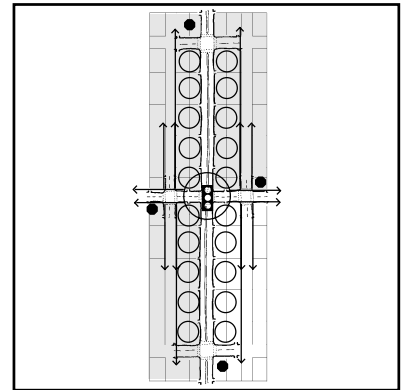

Connectors between town centers and neighborhood centers

Circulation at town centers

Signalized intersections—1/4 mile

Unsignalized intersections—1/8 mile

Direct extension of pedestrian and transit focus for civic, cultural, religious and parks activity within 1/4 to 1/2 mile distance from center

Street function is to provide arterial movement, but to balance with pedestrian scale of the mixed use center

Median type: barrier (raised or depressed, planted); turn lanes necessary at intersections
Minimal direct access

Frontage roads may be used

Required well-developed internal circulation systems

From the road, signage and placement of buildings should be visible at 50-55 mph speeds

Building orientation: may rotate off the 55 mph arterial and intersecting 35 mph arterial to accommodate circulation

Building transparency: greatest transparency should be toward local street parallel to 55 mph arterial

Connectors between centers

Signalized intersections—1 mile

Unsignalized intersections—1/2 mile

Street function prioritizes movement over access

At least one axis should connect directly into a regional highway; the other should decrease in section width as it enters into adjacent neighborhoods

Urban Design Template for 45/55 mph Intersection

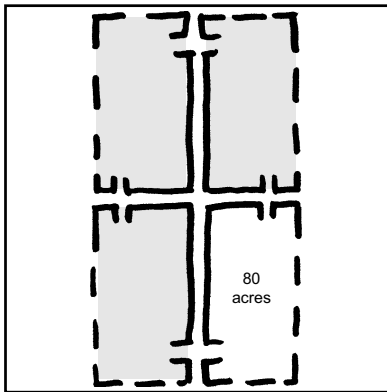

Planning Area

Rectangular planning areas of approximately 80 acres; minimum access spacing at 350' or 500'; internal pedestrian and vehicular circulation with marked/signalized crossings; location best for park and ride or timed-transfer center.

Curb to Curb

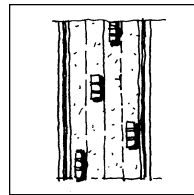
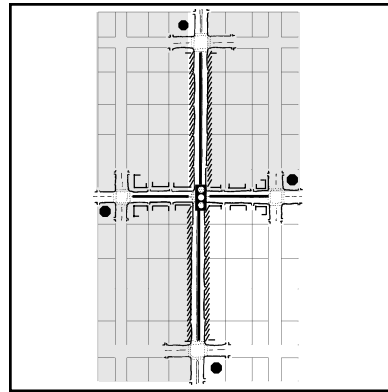

Right of Way

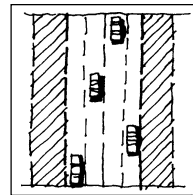
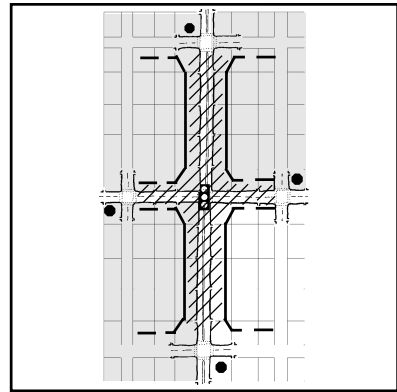

Livable Community Place

This place is a mixed-use activity and movement intersection bringing together the place assets of community and subregional centers.

A proposal by the City of Shoreview to redevelop the north-east corner of Lexington Avenue and County Highway 96 is such an example. The place will include expanded civic center, industrial sites upgraded to high-tech office buildings, compact commercial activity that is pedestrian friendly, and a range of lifecycle housing choices.

45
mph

CSAH/MSA Design Standards

Urban cross-section (curb/gutter) but may be rural cross-section (shoulders, drainage swale)

Travel lanes: 12 feet

Turn lanes: 11 feet

Median width: 4 feet (min.)

Transit: limited stops and express routes; some local routes

Pedestrian: detached paths/sidewalks adjacent to road; crossings at intersections

Bicycle: marked lanes, 4 feet (min.)

Parking: moves off-street and into the land use realm

Pedestrian: walks adjacent to road or detached paths; crossings at intersections

Sidewalks: 6 feet

Planting strip: 5-6 feet; between sidewalk/path and curb to buffer pedestrian from vehicles
Reaction distance: 4 feet

Transit stops: pulled back from intersection (to accommodate larger corner radii/right turn lanes); orient stops and enlarge waiting areas to accommodate transfers

Parking: off-street only

Streetscape: linear corridor configuration

Transit stops: freestanding; integrated into streetscape

Network Building Block

The 45 mph axis is best as access to a town center whose buildings address the road, but whose activity focuses in the center of the planning area. Such places are better suited for higher housing densities for owners seeking immediate access to many amenities.

The 55 mph axis is suitable for extending the natural systems. Transit would use this axis for limited-stop connections between timed-transfer centers. These facilities might be located on this axis and designed as a high amenity pedestrian connection to the town center.

55
mph

TH/CSAH Design Standards

Generally rural cross-section (shoulders and drainage swale)

Travel lanes: 12-14 feet

Turn lanes: 12 feet

Median width: 6-22 feet

Transit: express routes; hub to hub movement

Pedestrian: detached paths; minimal crossings

Bicycle: detached paths

Parking: off-street only

Pedestrian/Bicycle: detached paths; crossings at intersections or grade-separated

Sidewalks: 6 feet

Planting strip: 5 feet (nominally in reaction area)

Reaction Distance: 10 feet; may include drainage swale

Transit stops: move off-street into hubs or very widely spaces; bus bays (pullouts) may be appropriate at such stops

Parking: off-street only

Linear open space for water management

Access Management

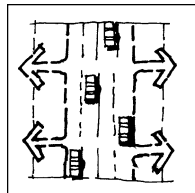
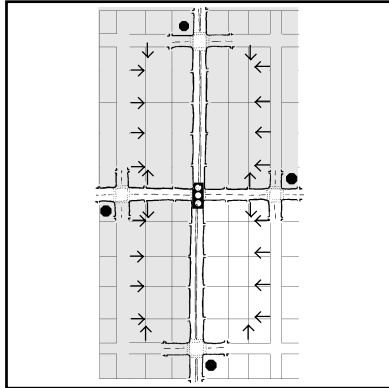

Median type: may be undivided; turn lanes necessary at most intersections

Limited direct access

Focus access at mid-block or onto lower speed cross street

Consolidate on-site/off-street circulation on individual parcels if lot dimensions are narrower than access spacing (use cross-easements, shared drives, shared parking)

View Shed

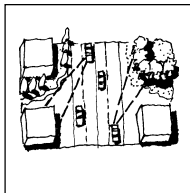
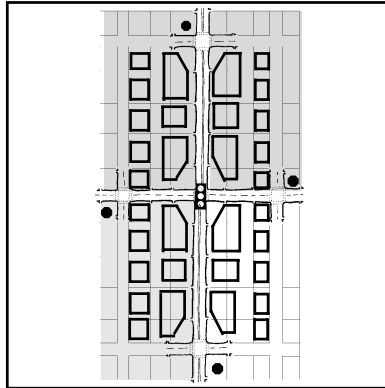

From the road, signage and placement of buildings should be visible at 40-45 mph speeds

Building orientation: local street parallel to 55 mph arterial becomes interior main street; larger buildings should be adjacent to 55 mph arterial; 45 mph arterial provides gateway to site

Building transparency: greatest transparency should be internal to site

Community Connections

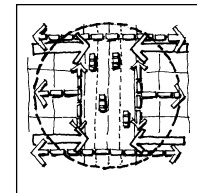
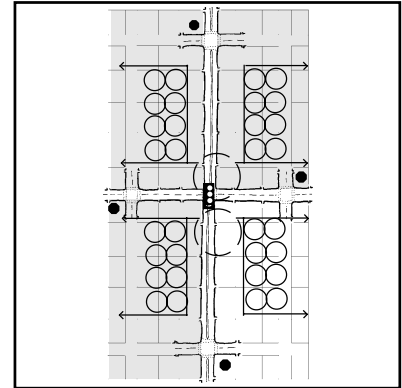

Commercial corridors at and between town centers

Signalized intersections—1/2 mile

Unsignalized intersections—1/4 mile

Street function is to provide arterial movement, but to balance with transit and linear corridor concepts

Median type: barrier (raised or depressed, planted); turn lanes necessary at intersections

Minimal direct access

Frontage roads may be used

Required well-developed internal circulation systems

From the road, signage and placement of buildings should be visible at 50-55 mph speeds

Building orientation: may rotate off the arterial to address circulation

Connectors between centers

Signalized intersections—1 mile

Unsignalized intersections—1/2 mile

Street function prioritizes movement over access

At least one axis should connect directly into a regional highway; the other should decrease in section width as it enters into adjacent neighborhoods

CASE STUDY APPLICATION

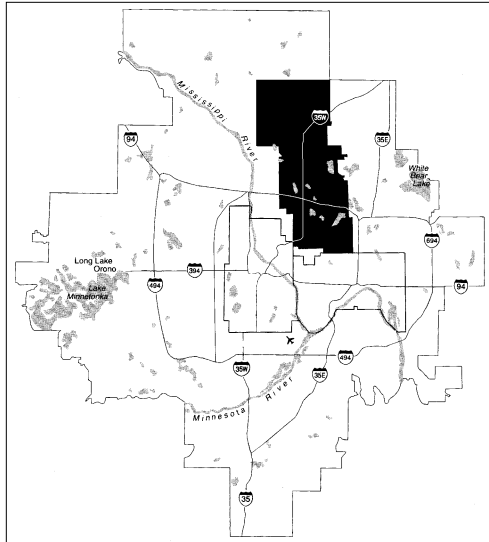

Figure 23. Case Study Subregion: I-35W Coalition.

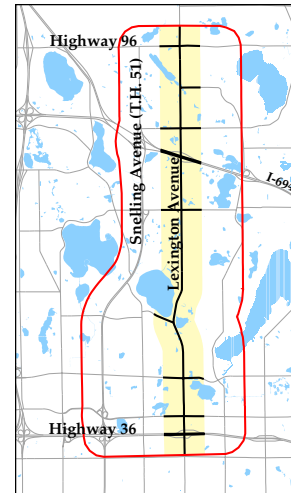

Figure 24. Case Study Arterial Segment: Lexington Avenue from Hwy 36 to Hwy 96.

Background

The broad goal of this case study is to test the proposed road prototypes and urban design templates in the existing suburban landscape and to explore their utility as a means for reorganizing existing sites and roadways for better performance. The case study also explores the subregional implications when using the prototypes and templates to build an activity and movement network.

Methodology

The case study uses an urban design analytical framework and process. The current “fabric” of the subregion and segment is inventoried and then assessed for livable community potential. The prototypes and templates are then employed to bring clarity and to define “what might be” if livable community principals are applied. This case study stops short of the final step, which would investigate the financial and political implications for implementation. The framework and process that was followed can be summarized in these statements:

- Recognize and reinforce the fundamental strengths, functions, and assets of an area.
- Aggregate more intense retail, commercial, and residential uses into clusters.
- Utilize “in-between” areas of residential uses by reorganizing arterial-edge parcels.

The case study investigates two scales of application: the subregional network and sites along an arterial segment. Rather than presenting each scale separately, they are described in tandem, which is how they function on a daily basis. By working across scales in an iterative fashion, the dynamics of the scale relationship become more apparent along with the adjustments that must be made to improve functions within the respective scales (e.g., the road straight away) and at points where the scales intersect (e.g., the road intersection).

Study Areas: Subregion and Arterial Segment

The case study focuses on the subregion created by the North Metro I-35W Coalition. The subregion borders the central city of St. Paul, extends north to the edge of the metropolitan region, and includes the cities of Arden Hills, Blaine, Circle Pines, Mounds View, New Brighton, Roseville, and Shoreview.

This area was selected because it encompasses first, second, and third ring suburban development and experiences the full-range of transportation and land use issues confronting the metropolitan region. The suburban arterial network that serves this subregion is characteristic of the arterial network throughout the region in terms of facility type, average daily trips, and adjacent land use patterns.

Several principal arterials serve travelers within and through the subregion. Interstate Highways 35W North and 694 intersect in the central part of the subregion; Highway 36 carries east-west traffic through the south-

ern part of Roseville; Highway 65 carries north-south traffic through the western portion of Blaine; and Highway 610 is a newly opened bypass north of I-694 that carries traffic across the Mississippi River. Several major arterial segments also lie within the subregion: Highway 51/Snelling Avenue links St. Paul with Roseville and ends at the intersection with I-694; Highway 10 is a former State Trunk Highway that was recently turned back to Ramsey County; and Lake Drive through Circle Pines is a residual connection to Duluth.

Congestion patterns on the principal and major arterials appear to be worsening over time. Unlike some segments in other parts of the region, however, they are directional and span a shorter time frame. For example, portions of I-35W South are congested in both directions for a larger portion of the business day, while portions of I-35W North experience southerly congestion in the morning and northerly congestion in the evening. Principal arterial congestion encourages use of the minor arterials as relievers to freeway congestion especially at key bottlenecks such as the interchange between I-35W North and I-694.

A 5.5 mile segment of Lexington Avenue is analyzed in greater depth. The northern boundary is County Highway 96 and the southern boundary is State Highway 36. This segment was selected because, like the subregion, it is typical of many arterials in how it functions, in its carrying capacity, and in the range of adjacent development patterns and environmental situations beyond its right of way.

Lexington Avenue is an extension of Lexington Parkway in St. Paul. It follows a U.S. Land Survey section line bending to the west as it leaves Ramsey County and enters Anoka County—evidence of the survey grid shift. Development patterns along the segment in this case study can be divided into two types with County Road E serving as the transition zone. The types are characterized by highly connected grid system south of County Road E and by cul-de-sacs and minimum access collectors north of County Road E.

The study segment operates in tandem with Snelling Avenue (Highway 51) from Highway 36 to I-694. Snelling Avenue, once it leaves the Rosedale Mall area, is a four-lane divided facility with minimal access. It connects with I-694 and Highway 10 and offers access to the Lexington/I-694 activity center. According to the Ramsey County Public Works Department, the southern portion of Lexington Avenue functions remarkably well. It is striped for three-lanes and on some segments carries up to 15,000 vehicles a day without significant congestion (1997 A.D.T. data). The northern end of Lexington is problematic. Although there are four lanes, congestion is considerable during rush hours. The interchange with I-694, the high concentration of workers with similar schedules, the presence of apartment complexes and townhomes—all of which feed directly on to Lexington—contribute to the congestion.

In addition to this subregion being representative of suburban areas in the metropolitan region, the I-35W Coalition's ongoing work in the area of subregional planning also makes it a desirable area to study. Currently, the Coalition is engaged in a 2020 Subregional Growth Study (funded in part through a grant from the Metropolitan Council's Livable Community Demonstration Account). One purpose of the study is to consider different growth options for the next twenty years and to assess impacts on local and regional infrastructure and resources. Two basic options are being considered: growth according to conventional suburban standards and growth using livable community principles and standards. The Coalition has completed the first phase of this study, which generated background research on: (1) current activity and movement; (2) areas that are likely to experience development or redevelopment in the next 20 years; and (3) a range of options for managing anticipated growth in jobs and households for the next 20 years. Since communities have been involved in all aspects of the growth study, there is a high degree of confidence that the information used in this study is well grounded and a fair representation of issues and opportunities for change.

An added benefit of working with the Coalition is access to their Geographic Information System (GIS) compatible data that has been amassed at the subregional level. The Coalition has compiled a broad range of planning data and standardized it across municipal and county boundaries. The Coalition has data sharing agreements with a variety of providers, such as Anoka and Ramsey Counties and the Metropolitan Council. It also has created current sets of socio-demographic data that are available for fine-grained analysis. Because this research is a collaboration with the Coalition, these data were made available for the purposes of the case study. These data enable an accurate comparison between micro analysis along the segment and macro analysis of the subregion.

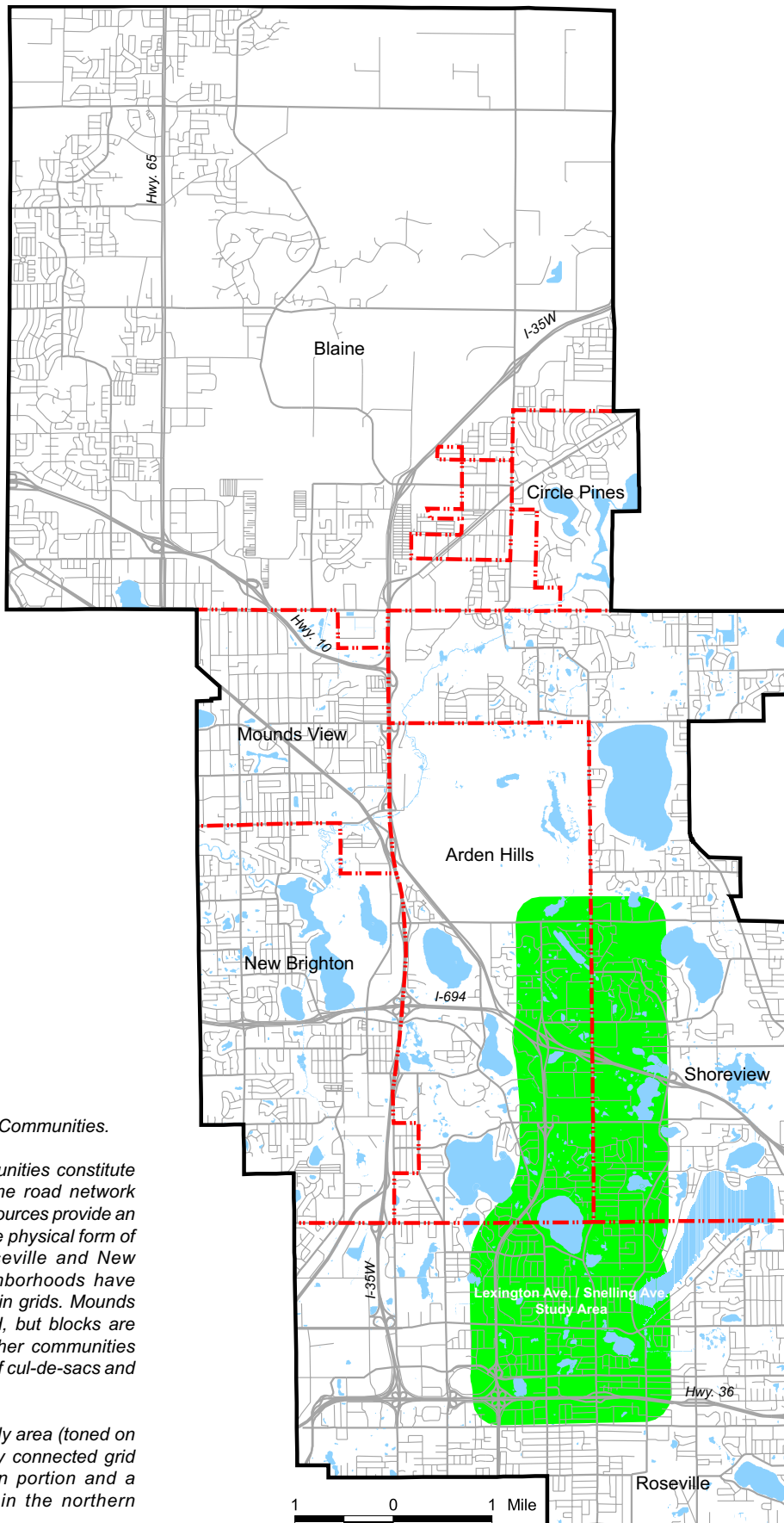

Map 1. I-35W Coalition Communities.

Seven suburban communities constitute the I-35W Coalition. The road network combined with water resources provide an excellent overview of the physical form of the subregion. In Roseville and New Brighton several neighborhoods have small blocks organized in grids. Mounds View maintains the grid, but blocks are considerably larger. Other communities are notable for the use of cul-de-sacs and truncated local streets.

The Lexington Ave. study area (toned on the map) has the highly connected grid pattern in the southern portion and a disconnected pattern in the northern portion.

Data Sources: Coalition cities, Anoka County, Ramsey County, The Lawrence Group., PlanSight, LLC.

Livable Community Context

The first part of the case study establishes urban design and livable community context and opportunities for applying the roadway prototypes and urban design templates. The study focuses on five key themes of livable community: (1) activity centers, (2) parks and open space, (3) homes and neighborhood, (4) economy and workforce and (5) transportation. The context establishes the design “advantage” that leverages local resources into distinctive places. Under each theme, livable community opportunities are listed for the Lexington Avenue segment. Opportunities suggest how design advantages can be converted into specific changes in road design and development patterns.

The second part of the case study synthesizes opportunities into a comprehensive land use and transportation concept for the Lexington Avenue segment. Templates and prototypes are used to refine the concept and identify specific site changes that could be made to achieve livable community goals. Lessons learned from this exercise are then applied across the subregion to develop a conceptual plan for the network.

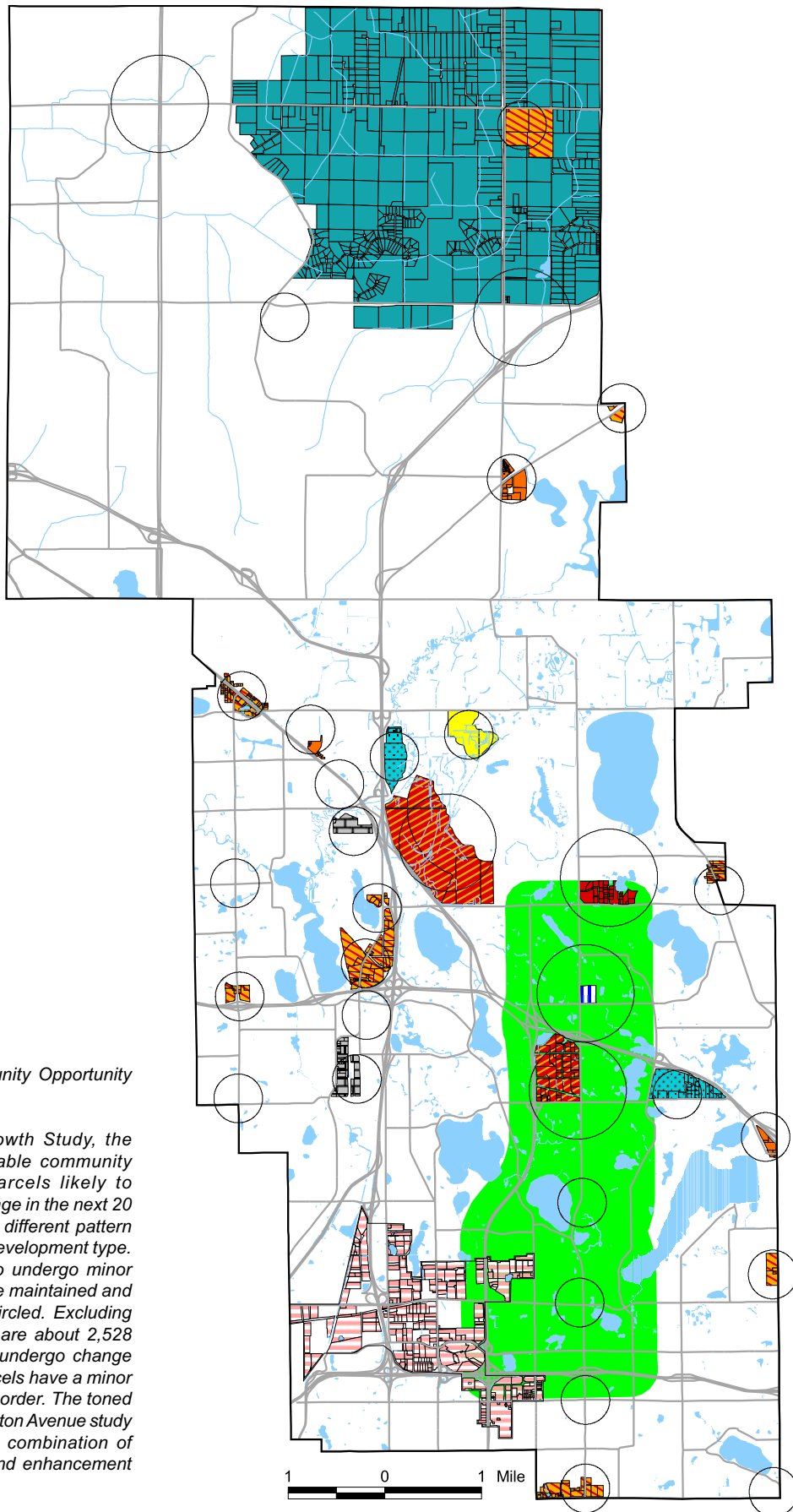

Map 2. Livable Community Opportunity Areas.

In its Subregional Growth Study, the Coalition identified livable community opportunity areas. Parcels likely to undergo significant change in the next 20 years are shown with a different pattern to indicate a preferred development type. Activity centers likely to undergo minor change or that should be maintained and enhanced have been circled. Excluding northeast Blaine, there are about 2,528 acres of land about to undergo change and nearly all of the parcels have a minor arterial for at least one border. The toned area indicates the Lexington Avenue study segment. It contains a combination of major redevelopment and enhancement opportunities.

Data Sources: Coalition cities, Anoka County, Ramsey County, The Lawrence Group., PlanSight, LLC.

Activity Centers

Places in suburban communities generally fit into three levels of activity: regional/subregional, community/town, and neighborhood. (Household activity represents a fourth. It, however, is dispersed across the landscape between clusters of activity just described.) Assigning a place to an activity level is as much a qualitative judgement as it is a quantitative analysis, so for case study purposes the following definitions were used to distinguish between levels:

- regional/subregional – 1 mile radius, job or event magnet, suitable for 12 units/res. acre, transit hub and or LRT station, large scale single or mixed use
- community/town – 1/2 mile radius, mixed use development (vertical and horizontal), time-transfer station, high frequency service for 18 hours, medium scale development, suitable for 7-10 units/res. acre, civic activities, parks
- neighborhood – 1/4 mile radius, small scale pedestrian oriented development, neighborhood gathering spots
- household – areas characterized by single family detached or attached housing

The I-35W Coalition subregional build-out study identified three tiers of activity centers and/or clusters. The dotted circles are subregional centers, the black lines are town centers and the areas in gray hatching are neighborhood centers.

There are several observations to make about the relationship between these centers and the arterial network.

- 1) The arterial network links these centers together, providing a location for the activity as well as a connection to and between activities.
- 2) The distribution of centers along the arterials breaks into patterns:
 - neighborhood center only
 - continuous neighborhood center activity (series of nodes)
 - neighborhood nested inside either town or subregion
 - neighborhood, town, and region in sequence, not overlapping or continuous
- 3) The Lexington Avenue segment has all three types of activity centers with portions that intersect with household activity or dedicated open space.

Lexington Avenue Opportunities

As these centers continue to evolve because of new development, infill and redevelopment, there is potential to add to the existing land use activity. In each center, the land will be developed more intensely, with a focus on compact transit and pedestrian oriented mixed-use development. More housing will be added at densities of 7-12 units per acre to the northern center, which presently contains commercial and industrial land uses.

Though each is a central focus to Lexington Avenue, the centers have adjacent and network relationships as well. At the southern end, the centers are focused on civic facilities and neighborhood functions. At the northern end, at the intersection of I-694, the centers function as community, subregional and metropolitan centers of commerce and commercial activity, as well as for new housing development. In each center, new housing will be integrated with adjacent neighborhoods through connections and upgrade renovations of existing homes.

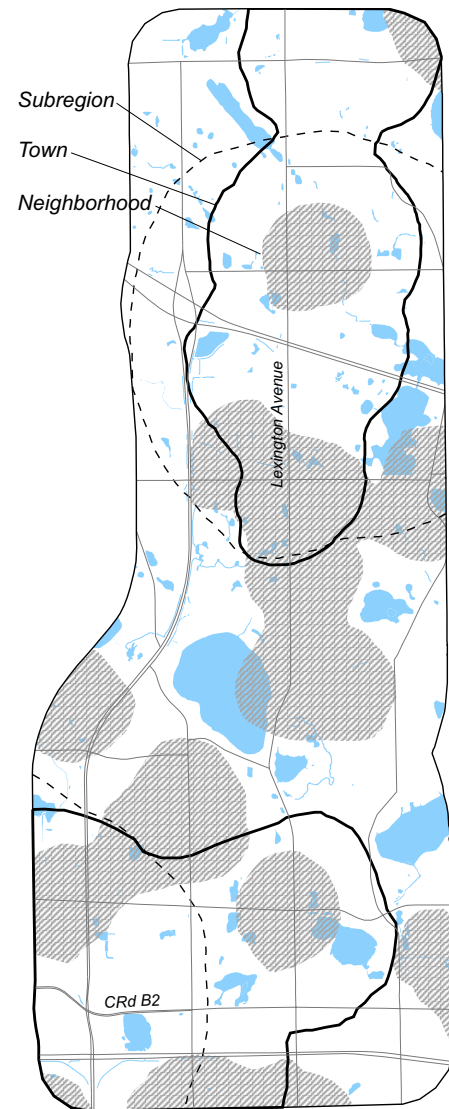
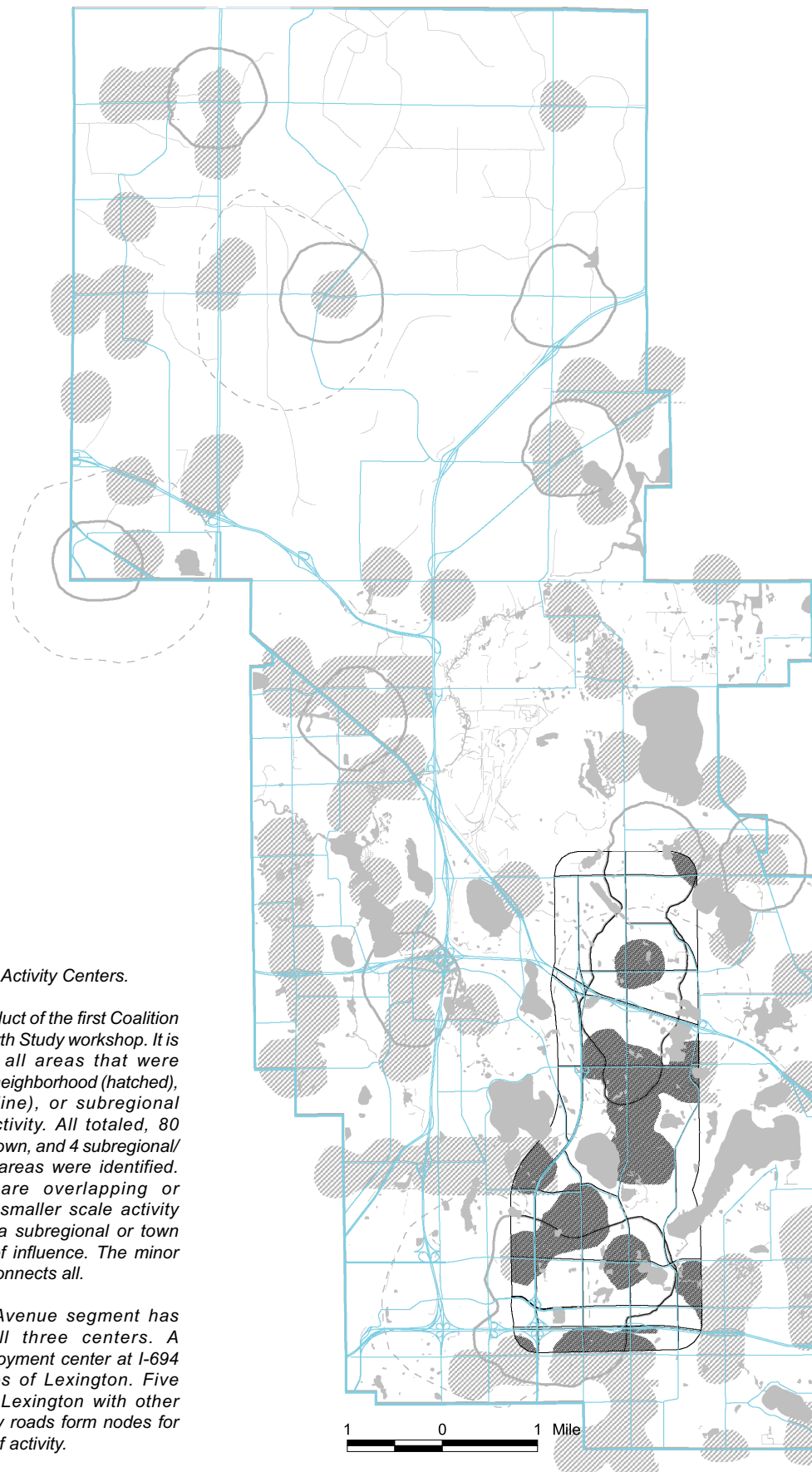

Figure 25. Activity Centers.



Map 3. Suburban Activity Centers.

This map is a product of the first Coalition Subregional Growth Study workshop. It is a composite of all areas that were identified to have neighborhood (hatched), town (solid outline), or subregional (dashed line) activity. All totaled, 80 neighborhood, 9 town, and 4 subregional/regional activity areas were identified. Many centers are overlapping or contiguous with smaller scale activity occurring inside a subregional or town center's sphere of influence. The minor arterial network connects all.

The Lexington Avenue segment has examples of all three centers. A subregional employment center at I-694 spans both sides of Lexington. Five intersections of Lexington with other arterials or county roads form nodes for the other scales of activity.

Data Sources: Coalition cities, Anoka County, Ramsey County, The Lawrence Group., PlanSight, LLC.

Parks and Open Space

To many suburban residents, the image of their home and community is a place wrapped by open space and natural systems of woods, wetlands and lakes. This image is created in two ways: first, through the aggregated domestic landscape of yards and gardens, and second, by traveling along the roadways that pass through or along natural open spaces and recreational amenities. The beauty and vitality of a suburban community’s natural environment—the experience of the topography, lakes, trees, grassland and wetland—all contribute to its quality of life.

Visual access is a key design concern in maintaining human connection with this environment. A roadway’s view shed and right of way should be part of the community’s natural environment, especially in residential areas. The size and structure of the road plays a primary role as both a physical and visual component to the natural system in three ways: (1) it is a defining edge that helps delineate the visual boundaries of an “outdoor room”; (2) it provides visual and physical access via views and trails; and (3) it can be designed to connect with and augment the eco-structure that contributes to water and air quality.

As more compact mixed-use development is built in the subregion, the environmental image and quality of the natural landmarks that are a community’s quality of life symbol must be maintained and enhanced in the redesign of the arterial network. The roadway carries not only people, but flows of water, plants and animals. The roadway section’s landscape system and plant forms should be designed as part of the community’s larger natural systems, contributing to water and air quality management and habitat enhancement.

Lexington Avenue Opportunities

The Lexington Segment begins in a wetland complex and rises to a small hill near the Roseville civic center. From here, it continues north, bends, and drops in elevation as it follows the contour of Lake Josephine’s shoreline. At this point the road divides Lake Josephine, a dominant cultural feature, from its adjacent wetland. Further north, a finger of open space connects Lexington to Island Lake. North of the study segment, Lexington creates an edge to the natural areas that are part of the Twin Cities Army Ammunitions Plant site.

Central Park: Lexington is the western entrance to this substantial community amenity. Opportunities exist to calm traffic to ease and encourage pedestrian and bicycle traffic. A substantial residential population lies to the west and north of the park; enhanced pedestrian crossings would increase accessibility. North of County Road C, environmental strategies that capitalize on stabilizing and enhancing the vegetation and water movement of the upland ecosystem would benefit the environment and become a complementary amenity to the wetlands of the park system.

Lake Josephine Swimming Beach and Wetland: The urban design opportunity here is for the road to accentuate its parkway qualities—in other words to provide views into the environmental rooms of the wetlands and to make it easy for people to move safely on foot or bicycle to access the swimming beach and adjacent amenities.

Island Lake and Karth Lake: Visual access will enhance the public presence of these hidden resources. Roadways and sites consciously designed to make the cognitive connection between resource and public more explicit would create that enhancement. There also is an excellent opportunity to use the roadway to restore portions of the ecosystem that were disturbed during earlier construction.

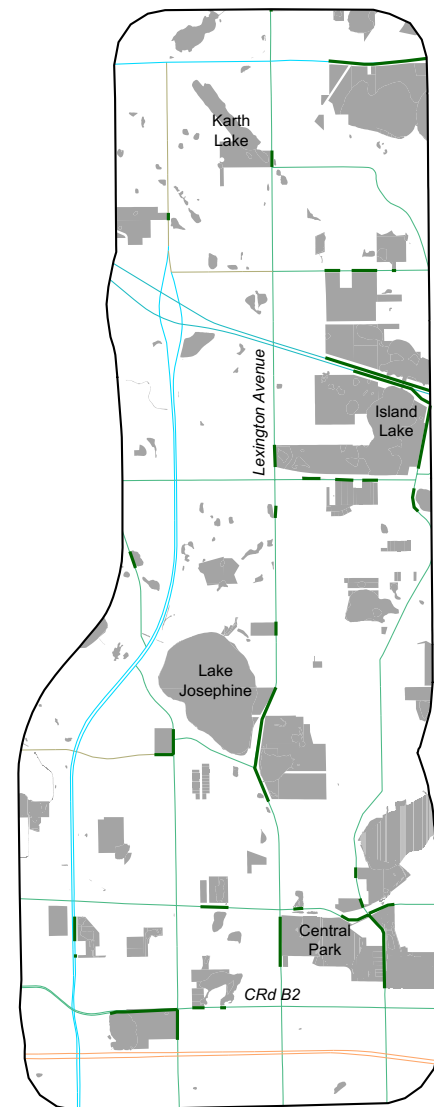
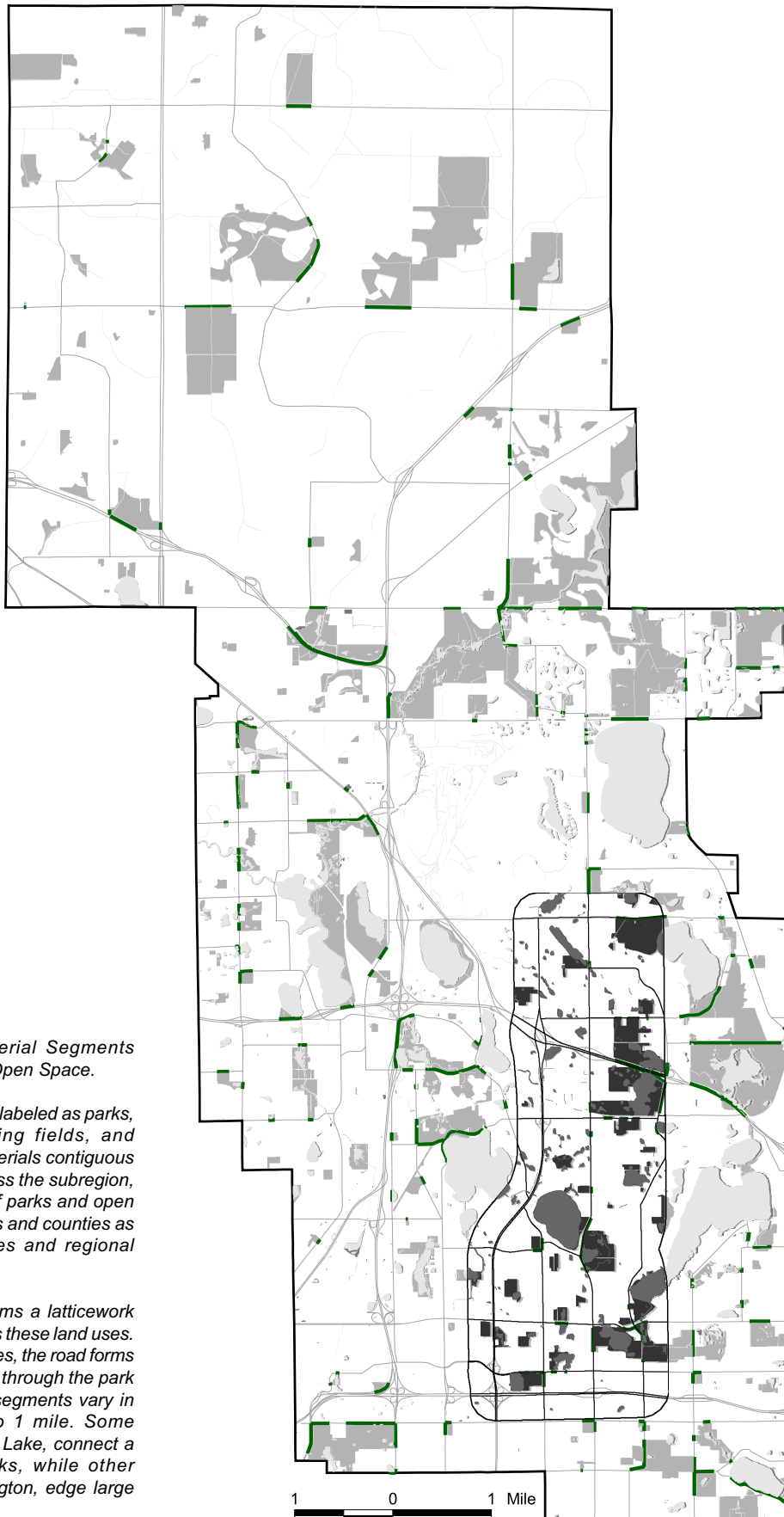

Figure 26. Arterial Segments Adjacent to Open Space.



Map 4. Suburban Arterial Segments Adjacent to Parks and Open Space.

This map shows parcels labeled as parks, open space, or playing fields, and highlights portions of arterials contiguous with these parcels. Across the subregion, there are 5,620 acres of parks and open space managed by cities and counties as neighborhood amenities and regional resources.

The arterial network forms a latticework that frames and connects these land uses. In over 109 different places, the road forms an edge or goes directly through the park or open space. These segments vary in length from 40 feet to 1 mile. Some arterials, such as Silver Lake, connect a series of smaller parks, while other arterials, such as Lexington, edge large parcels of open space.

Data Sources: Coalition cities, Anoka County, Ramsey County, The Lawrence Group., PlanSight, LLC.

Homes and Neighborhoods

Another, equally powerful, image of the suburb is the single family home on a large lot with easy access to a “good” road. In the this subregion, state and county roads were that good road. They operated like country roads, being an attractive foreground to the homestead, yet provided direct and quick access to jobs, schools, and shopping.

Over time, the nature of the relationship between the road and the home has changed. The good road is now a community corridor with multiple uses carrying significantly more traffic, and the single family home has been joined by apartment buildings, condominiums, and townhomes. The image of the suburb being predominantly residential, however, remains its primary selling point to new residents.

A sense of privacy, quietness, and safety plays a primary role in maintaining and enhancing this image. As suburban arterials and housing continue to evolve, residential land uses and access should be re-evaluated in four ways:

- reduce driveway access to the arterial;
- consolidate lots to create transit-supportive residential developments;
- revitalize and reorganize existing apartment and condominium complexes to improve access to transit and open space; and
- clarify and consolidate local intersections with arterials by reworking the local street network.

Lexington Avenue Opportunities

The majority of housing units directly connecting to Lexington Avenue are clustered in three locations: (1) at and around County Road C; (2) on either side of County Road E; and (3) between County Road F and County Highway 96.

County Road C: There are a number of homes with driveways onto Lexington. There is an opportunity to create a long-range implementation strategy to reduce the number of driveways, complete missing connections in the street grid, and improve access to transit. The strategy might include purchase of homes from willing sellers, re-orientation of residential sites, and augmenting regular street maintenance programs to include amenities for pedestrians and transit riders.

County Road E: The single-family residences near this intersection are prime for redevelopment into transit-supportive residential developments. Again, this would need to be approached on a willing seller basis and trail connections to mixed-use center should be planned as part of the site design and built in the first phase. A second residential opportunity is the construction of live-work housing to the town center. This housing type would provide more lifecycle options, create more evening activity that would enhance safety, and contribute to the mixed economy of the center.

County Road F to Highway 96: Currently, there are a number of existing apartments and townhomes, which approach densities that support transit use. Programs to renovate and reorganize existing apartment complex sites to be more transit and pedestrian friendly would maximize the higher intensity of residential use. They also would increase access to neighboring commercial, retail, and entertainment uses. Intensifying the local street grid is a second broad strategy for this area. Like the area around County Road C, more internal connections provide an alternative to using Lexington for short trips thus relieving access management pressures.

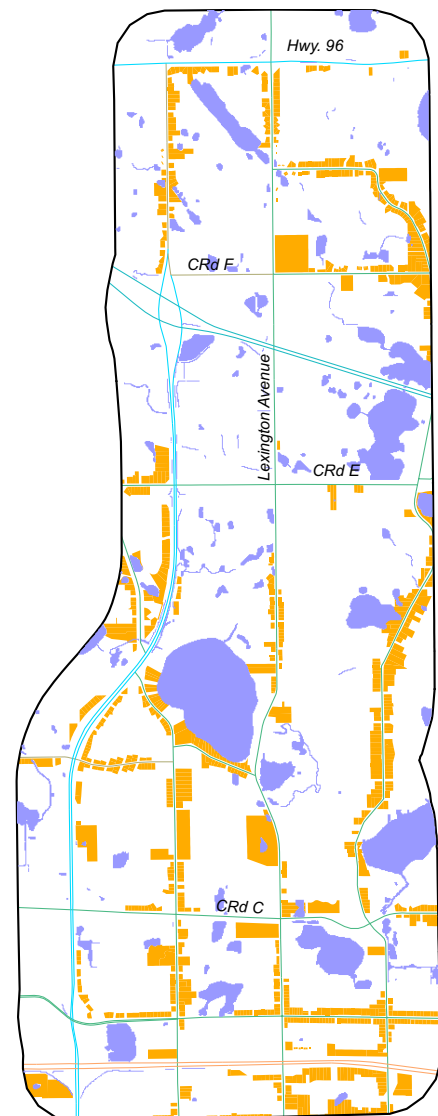
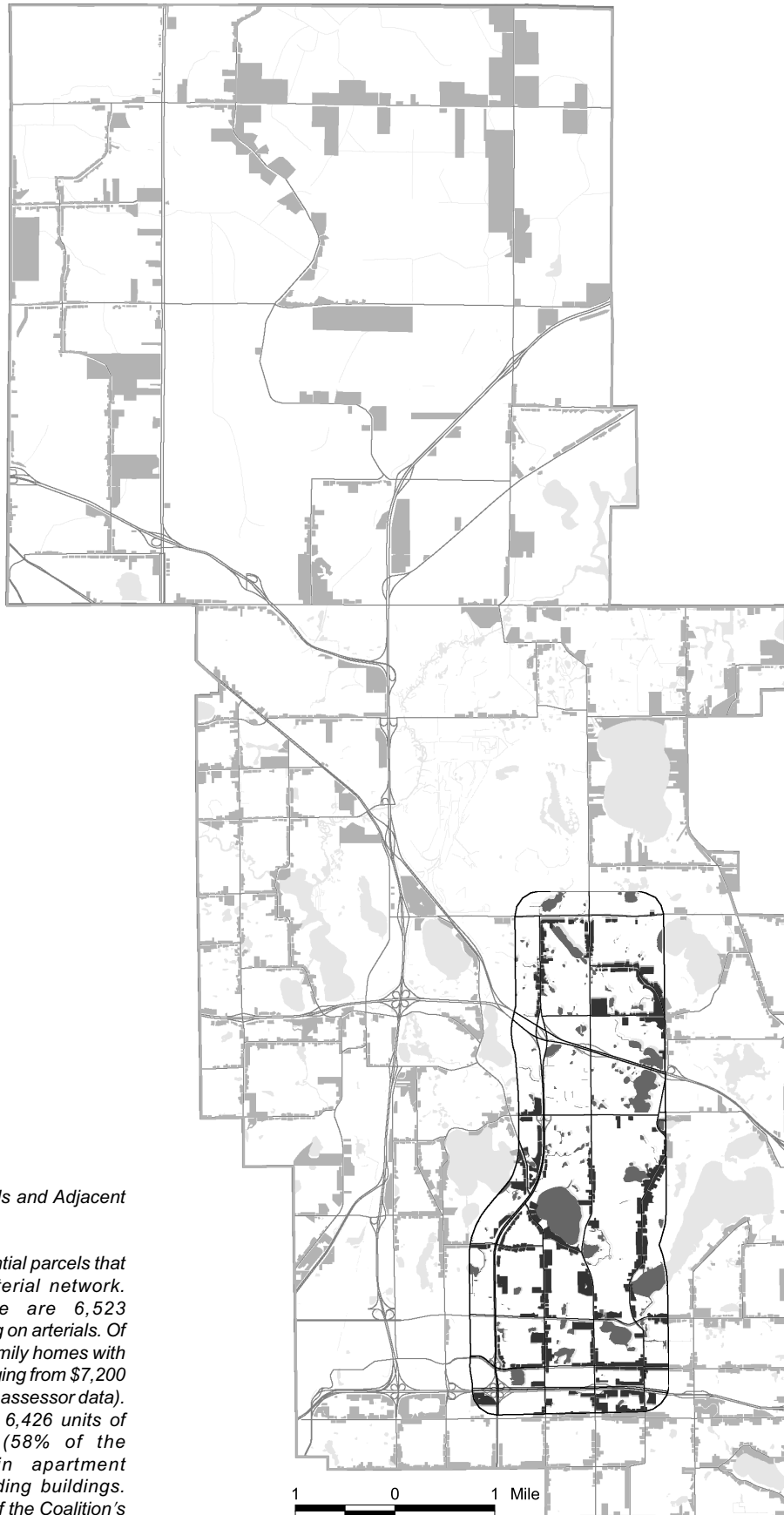

Figure 27. Arterial Segments Adjacent to Residential Parcels.



Map 5. Suburban Arterials and Adjacent Residential Parcels.

This map displays residential parcels that are adjacent to the arterial network. Subregion-wide, there are 6,523 residential parcels fronting on arterials. Of these, 6,243 are single family homes with total assessed values ranging from \$7,200 to \$676,180 (1999 county assessor data). There are an additional 6,426 units of multi-family housing (58% of the subregion) located in apartment complexes or freestanding buildings. Thirteen of the fourteen of the Coalition's manufactured home parks are located on arterials.

Data Sources: Coalition cities, Anoka County, Ramsey County, The Lawrence Group., PlanSight, LLC.

Economy and Workforce

Single-use zoning and freeway alignment and access were the land use and transportation decisions that gave form to commercial and industrial development in post-war suburbs. Shopping malls and strips, industrial parks, corporate headquarters, back office operations, and trucking terminals became the types of development that characterized the suburban tax base.

A hierarchical transportation system evolved to serve this sector of the economy. The county road slipped into a supporting role, providing commercial vehicles and automobiles with a way to bridge the span between individual sites and the freeway system. Where development did line the arterials, it was set back behind the parking lots that were adjacent to the road.

Macro changes in the economy are triggering micro changes in local economic development patterns. The land use language is moving conventional large-scale development into a more diversified mixed land use. Development on new or grayfield/brownfield sites is more compact. Housing and work weave together along open space networks, in a pedestrian friendly landscape that is transit oriented.

These changes in development patterns present an opportunity to introduce modifications to the circulation plan for the site design. New development or large-scale redevelopment presents the possibility of breaking a site into blocks with pedestrian networks internal to the site. This strategy reduces the need to move a car when going from business to business, increases controlled access to arterials, and encourages transit use. Incremental strategies, such as restriping parking lots with driving lanes, reconfiguring parking areas, and adding high-quality pedestrian pathways can become a blueprint for small scale development or redevelopment.

Lexington Avenue Opportunities

Roseville's Centre Pointe is an example of how shifts in the larger economy are affecting local redevelopment. Eco-friendly businesses with employees who work flexible hours are moving to this subregion and creating a demand for attractively designed, high-tech commercial buildings on amenity-rich sites. The area on Lexington between County Road E and Victoria Street is prime for conversion to this type of mixed-use redevelopment.

Commercial/industrial sites are mostly on the western side of Lexington. I-694 bisects the area and provides connections to the regional freeway network. Sites and blocks in this area are large in scale and have few internal connections. There is an opportunity to improve the functioning of Lexington by developing a long-range plan that would subdivide oversized blocks and build several internal circulation systems for vehicles and pedestrians. As in residential sites in this same area, the concept is to reduce use of Lexington for access to individual sites. This allows the design of Lexington to focus on its primary function in this location, which is access to I-694. It also creates an opportunity for more intensive transit service, because the job density would be higher, transit riders would be better connected to multiple sites, and the circulation design would be oriented for bus movement in and out of the sites.

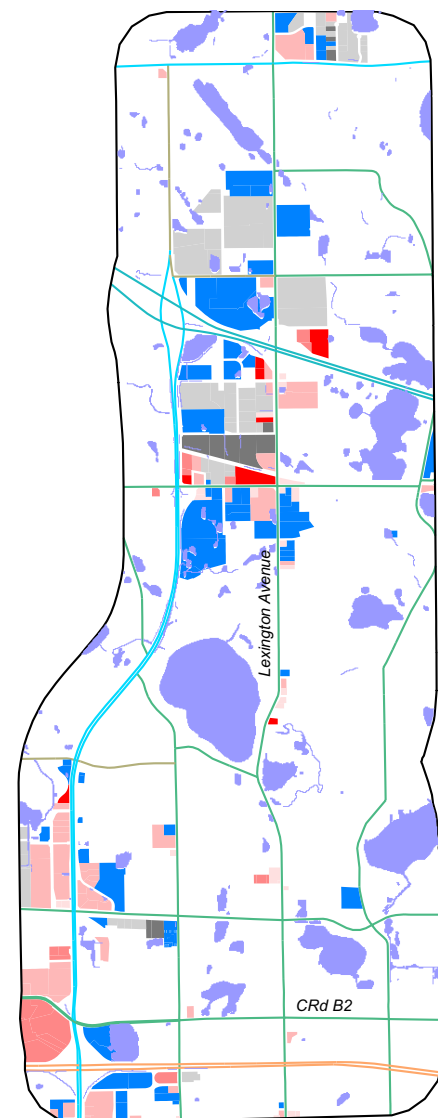
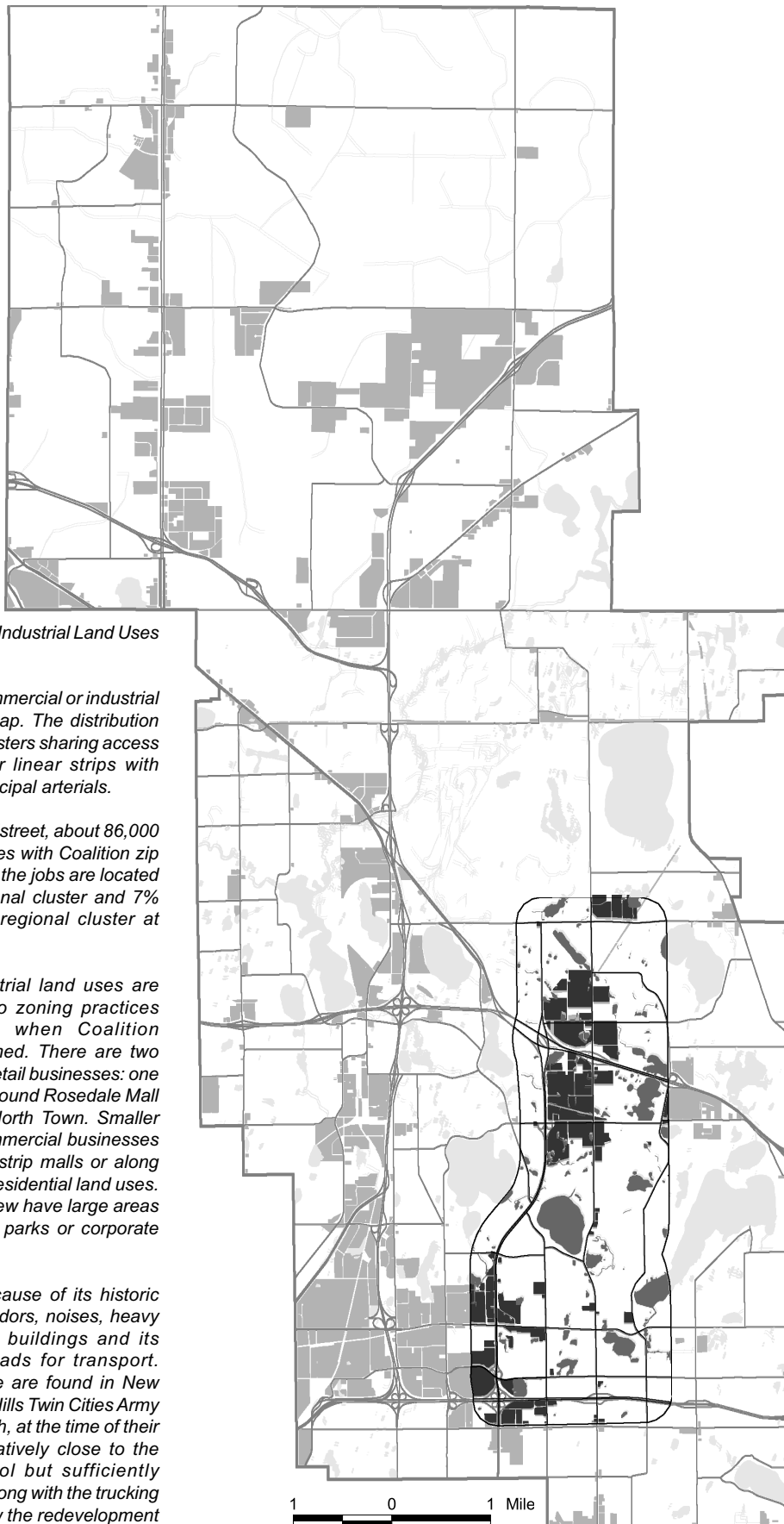

Figure 28. Commercial and Industrial Land Uses Adjacent to Arterials.



Map 6. Commercial and Industrial Land Uses and Adjacent Arterials.

Parcels identified as commercial or industrial are displayed on this map. The distribution pattern shows parcel clusters sharing access to principal arterials or linear strips with individual access to principal arterials.

According to Dun & Bradstreet, about 86,000 employees work in places with Coalition zip codes. Of these, 30% of the jobs are located in the 35W/36 subregional cluster and 7% are located in the subregional cluster at Lexington and I-694.

Commercial and industrial land uses are separated according to zoning practices common to the era when Coalition communities were formed. There are two subregional clusters of retail businesses: one in the immediate area around Rosedale Mall and the other around North Town. Smaller groups of retail and commercial businesses are typically located in strip malls or along arterials as a buffer for residential land uses. Arden Hills and Shoreview have large areas developed as business parks or corporate campuses.

Industry is isolated because of its historic reputation for noxious odors, noises, heavy equipment, and large buildings and its dependence on railroads for transport. Industries of this nature are found in New Brighton and the Arden Hills Twin Cities Army Ammunitions Plant which, at the time of their development, were relatively close to the Minneapolis labor pool but sufficiently removed from the city. Along with the trucking terminals, these are now the redevelopment sites of the future.

Data Sources: Coalition cities, Anoka County, Ramsey County, The Lawrence Group., PlanSight, LLC.

Transportation

The suburban movement image that underpins living in the suburbs is one of unobstructed motion—that is, the ability to travel from home to work, school, or shopping unimpeded by congestion or lengthy delays at signalized intersections. Until recently, this image was created by building a seamless network of principal and minor arterial roads that enabled use of the automobile as the primary transportation mode.

Recent empirical evidence shows, however, that adding more lane miles is not a feasible solution for the future. Induced traffic demand and high maintenance costs have reached the point of diminishing returns on the investment of public dollars. The alternative approach is to provide a transportation network that promotes efficient use of the automobile and a range of mode choices that is integrated and convenient.

Livable community urban design principles offer a starting point for creating a new hierarchy and order for activity and movement in suburban communities. Building type, location, and orientation; shifts in densities and use mixes; location of paths; and location and design of pedestrian amenities are key to successfully enhancing the suburban transportation mode palette.

Lexington Avenue Opportunities

Lexington Avenue has a continuous posted speed of 40 m.p.h. even though it passes through a variety of land uses and scales of activity. As land use and activity become more intense, mixed in use and transit dependent, the design and posted speeds will also need to vary. Ultimately, the movement goal is to manage traffic at an average trip speed of 40 m.p.h. Achieving this goal will require proper transitions between different design speeds so channel flow is smooth and continuous from one speed segment to another.

Alternative transportation modes on Lexington are more of an opportunity of the future than a reality of the present. Buses currently serve the portion of Lexington north of County Road E at less than frequent intervals. Service periods are oriented to the workforce reverse commuting from the central cities or journeying into the central city for day jobs. To bring service to the entire length of Lexington and increase services in activity centers would require increased residential and job densities. A second requirement is the improvement of site design and amenities to make walking to bus stops and waiting for the bus pleasant experiences.

The prospect of converting the rail right of way that crosses Lexington near County Road C to a transit way of some type holds another set of alternatives. It would be logical to have a stop at this intersection—especially given its civic character. Intensified land uses on Lexington would contribute to the financial and operational feasibility of a stop at this location.

Extension and intensification of the existing trail network is another opportunity. Currently, recreation use is the main focus of trail planning. But as job sites scale down in size and distances between job and home shorten, there is real potential for bike commuters to use the trail network as an alternative to the car. Proposed improvements to site circulation and access will make it easier and safer for bike commuters when they get off the trail and into multi-modal traffic situations.

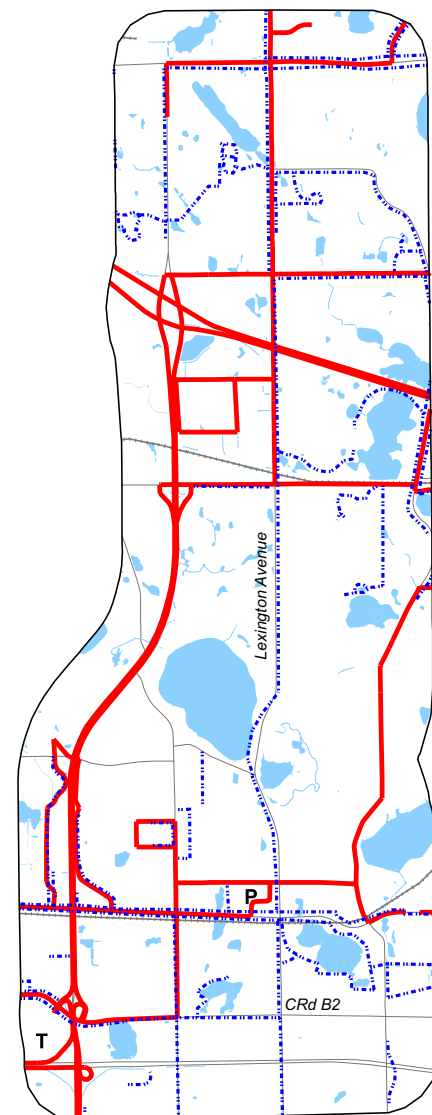
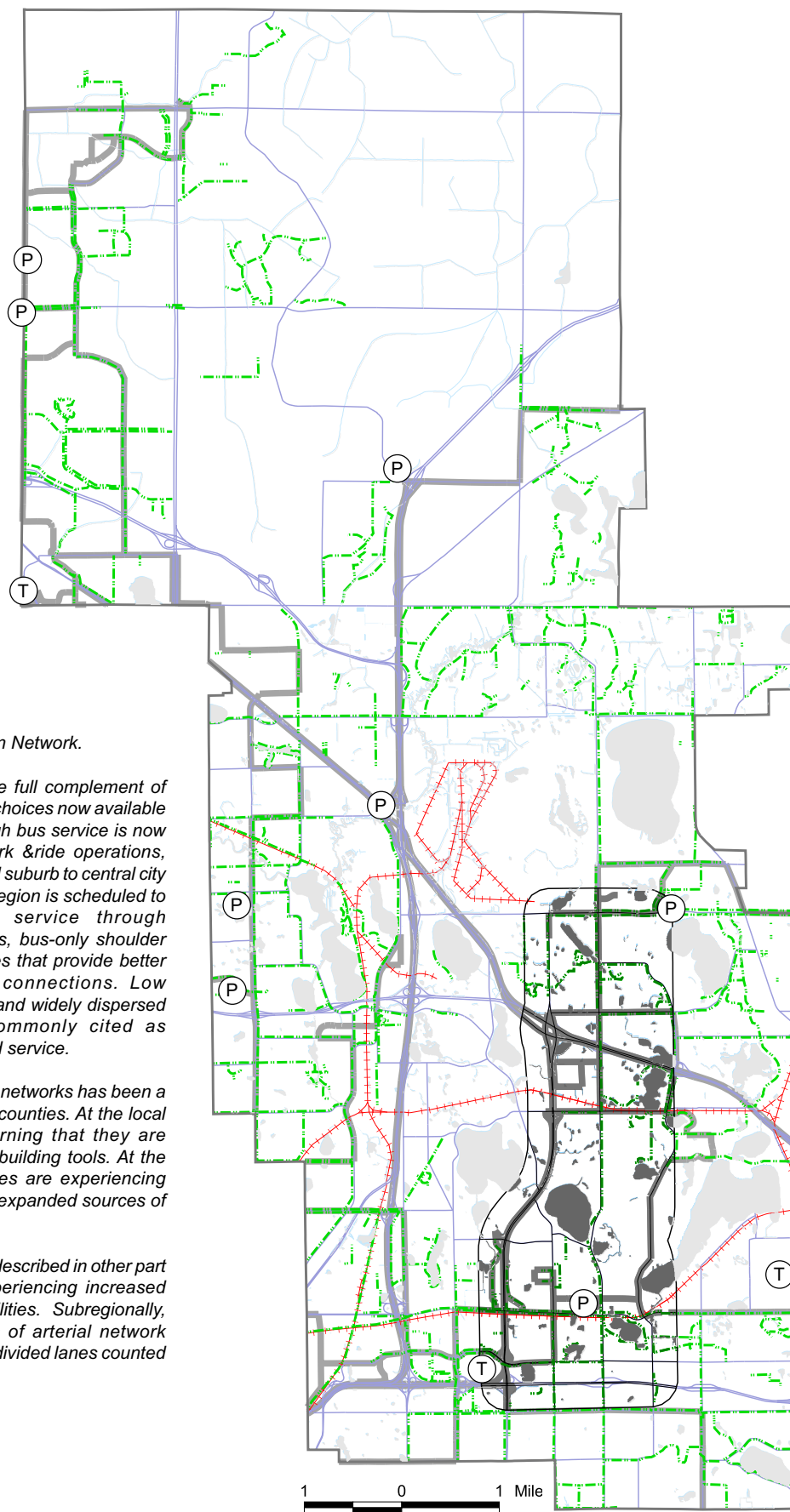

Figure 29. Transportation Network.



Map 7. Transportation Network.

The Coalition has the full complement of transportation mode choices now available in the region. Although bus service is now largely limited to park & ride operations, commuter routes, and suburb to central city local routes, the subregion is scheduled to receive improved service through expansion of facilities, bus-only shoulder lanes, and new routes that provide better suburb to suburb connections. Low residential densities and widely dispersed workplaces are commonly cited as justification for limited service.

Expansion of the trail networks has been a priority for cities and counties. At the local level, cities are learning that they are powerful community building tools. At the county level, agencies are experiencing greater demand and expanded sources of funding for trails.

The arterial network, described in other part of this report, is experiencing increased congestion on all facilities. Subregionally, there are 292 miles of arterial network (principal and minor, divided lanes counted in both directions).

- P Park and Ride
- T Transit Hub
- Bus Route
- - - Trail

1 0 1 Mile

Data Sources: Coalition cities, Anoka County, Ramsey County, The Lawrence Group., MetroTransit, PlanSight, LLC.

Lexington Avenue Analysis: Activity and Movement Composite

Several livable community opportunities have been identified for the Lexington Avenue segment. To narrow and define the field of opportunities presented in the contextual analysis, existing roadway conditions are paired with livable community goals. This step begins the process of “adding up” the opportunities into a network of interrelated places—a working whole. It has been done in two parts: one, a table that lays out basic transportation information about the Lexington segment, and two, an urban design movement schematic. In both cases, opportunities add up to minor changes in the framework structure of the activity and movement network, but major changes at the site and intersection scale. Similarly, adding up the opportunities defines the segments of roadway that should have a uniform speed, particularly areas between major intersections and identifies the locations where transitions between different speed conditions must be incorporated into the overall design.

	Existing Conditions	Livable Community Goals
Land Use	<ul style="list-style-type: none"> • Transition Zone: CRd E • South – residential uses are spread across a grid block pattern with small lots; multi-family housing is located on Lexington; commercial uses are clustered at arterial intersections • North – residential uses developed as subdivisions with cul-de-sacs; townhomes and apartment complexes provide higher densities; commercial and industrial uses are centered on large parcels and clustered around the I-694 intersection to create a subregional jobs center 	<ul style="list-style-type: none"> • Transition Zone: CRd E • General patterns would remain with further intensification of activity at nodes; residential uses would be introduced to nodes and gradually removed from areas where direct access disrupts the road function
Traffic Flow and LOS	<ul style="list-style-type: none"> • Transition Zone: I-694 • South – heavy at times, but seldom congested • North – heavy at times with frequent congestion during rush hours or bad weather 	<ul style="list-style-type: none"> • Based on the general simulation modeling described earlier, traffic flow and Level of Service should not suffer under the new scenario; in fact, some cross roads may experience slightly improved service
Number of Lanes	<ul style="list-style-type: none"> • Transition Zone: I-694 • South – 3 lanes, 2 directional lanes and a center turning lane • North – 4 lanes with two lanes in each direction 	<ul style="list-style-type: none"> • No reduction in the number of lanes; prototypes used are based on 2 travel lanes in each direction with turning lanes at appropriate intersections
Speed Limits	<ul style="list-style-type: none"> • 40 mph posted for the entire length 	<ul style="list-style-type: none"> • Limits would alternate between 35 mph and 45 mph with varying intensities of activity
Automobile Access	<ul style="list-style-type: none"> • Extensive and varied • Ramps – on and off Hwy 36 and I-694 • Intersections – 8 arterials, 25 collectors/others • Parcels with direct access – 112 	<ul style="list-style-type: none"> • Less extensive and varied • Reduce the number of entrances for businesses and residences
Transit Access	<ul style="list-style-type: none"> • No continuous route serves this segment; east-west routes cross near CRd B2, CRd F, and Hwy 36; north of CRd E, Lexington has bus service to and from the Shoreview Community Center; Snelling Avenue serves as a route link, but stops are limited 	<ul style="list-style-type: none"> • Mixed-use nodes would be developed at densities to support north-south transit service • Transit potential: hub or timed-transfer center at I-694; transit way near CRd C intersection
Pedestrian Access	<ul style="list-style-type: none"> • Pedestrian path/trail length of Lexington extends north and south • 8 intersecting trails and sidewalks connect to open space and recreational areas 	<ul style="list-style-type: none"> • Intensive pedestrian network in mixed-use nodes • Intensify trail networks and increase connections to create interior loops

Table 2. Lexington Avenue Activity.

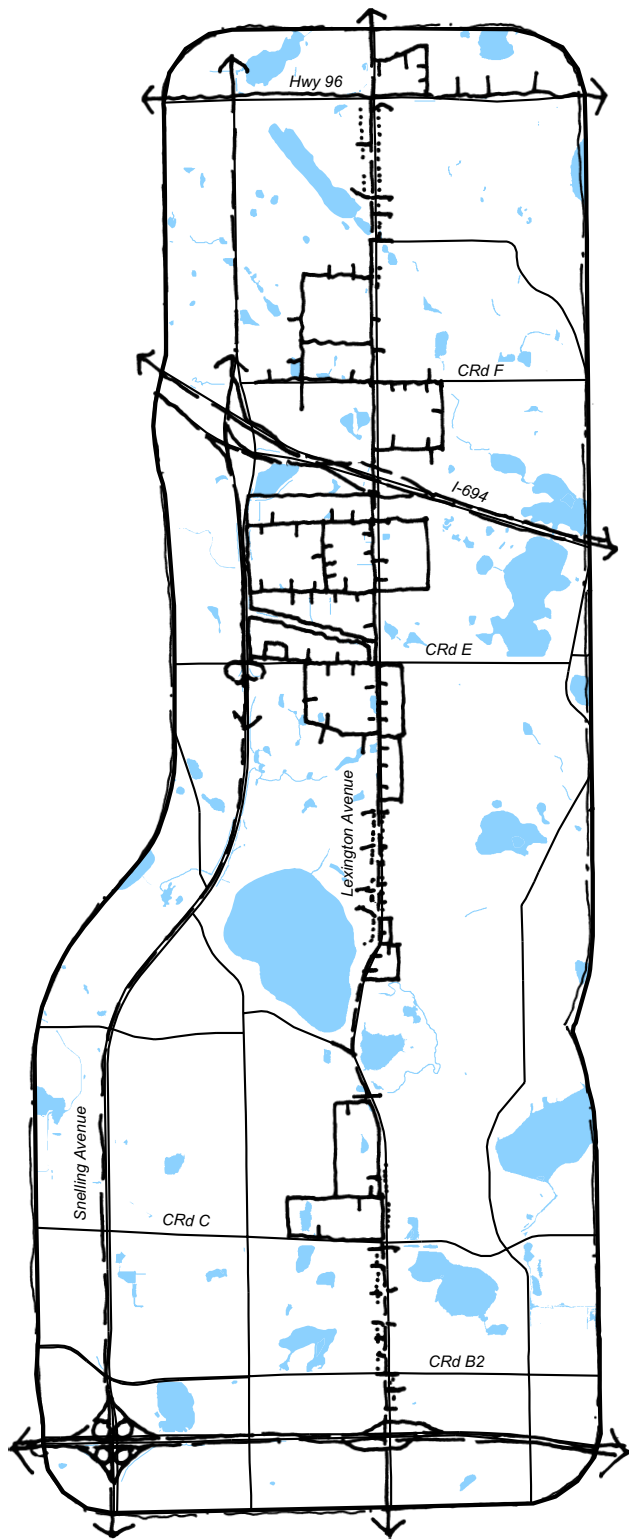

Figure 30. Existing Conditions.

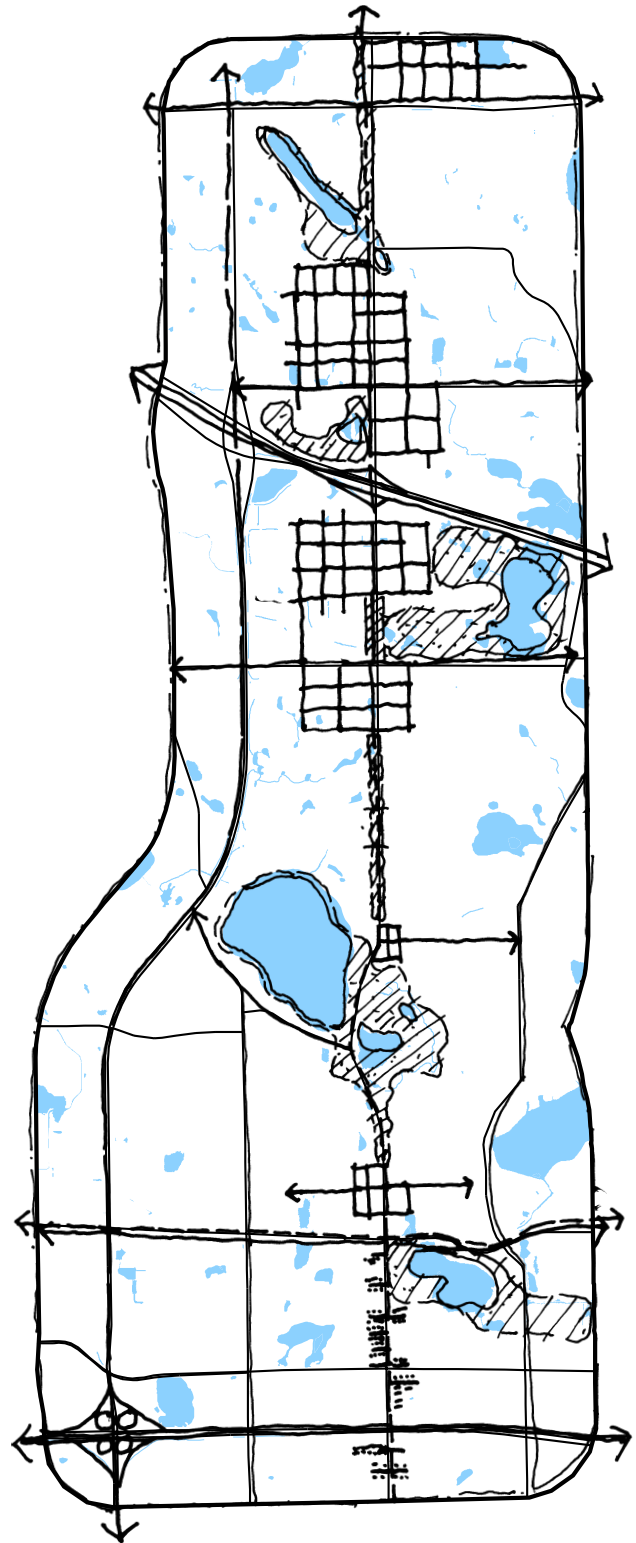

Figure 31. Livable Community Option.

Spacing and Community Connections

Concepts and opportunities are further refined by applying the templates to the Lexington Segment. Three templates are appropriate for the dominant movement and activity patterns found on Lexington: the 35/35 m.p.h. intersection; 45/45 m.p.h. intersection; and the 45/55 m.p.h. intersection. Using the templates and underlying land use and environmental conditions, it is possible to abstract a movement and activity framework for the segment. The framework identifies appropriate roadway prototypes for sub-sections and planning areas for further analysis and detailing.

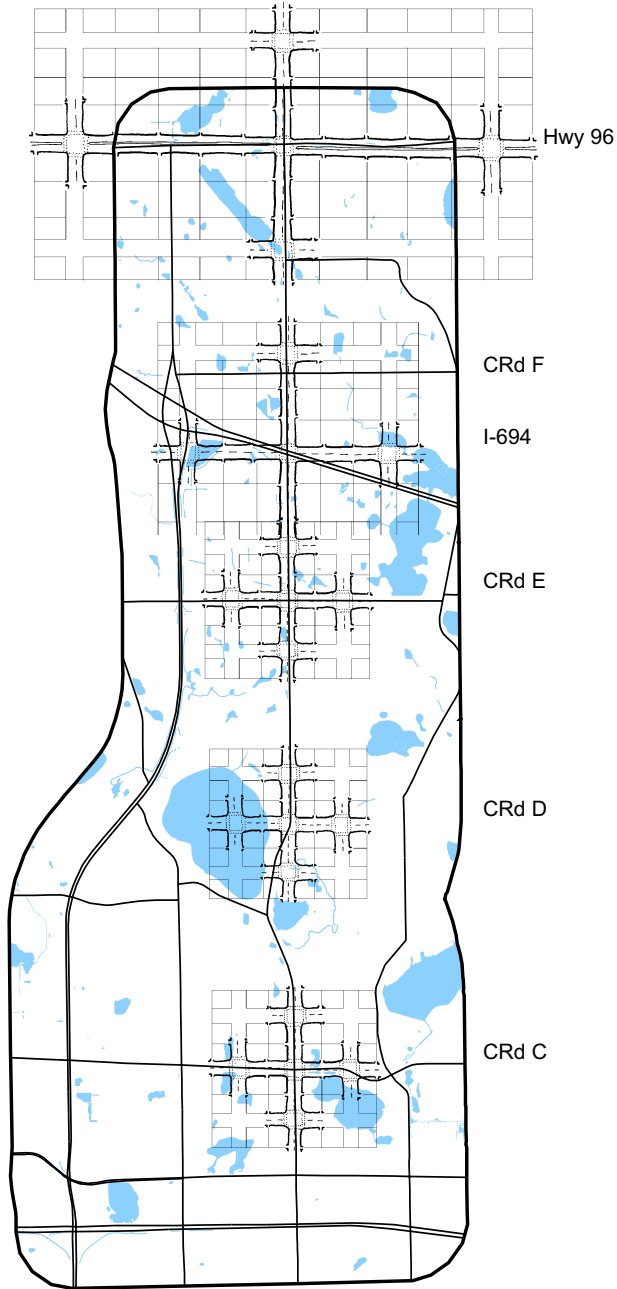

Figure 32. Template Application.

Activity intensity and mix and natural features were used to identify arterial intersections that are key to network building. The current and potential activity type and movement pattern determined which template was used. The outcome was a visual and geometric analysis of intersections where change might occur.

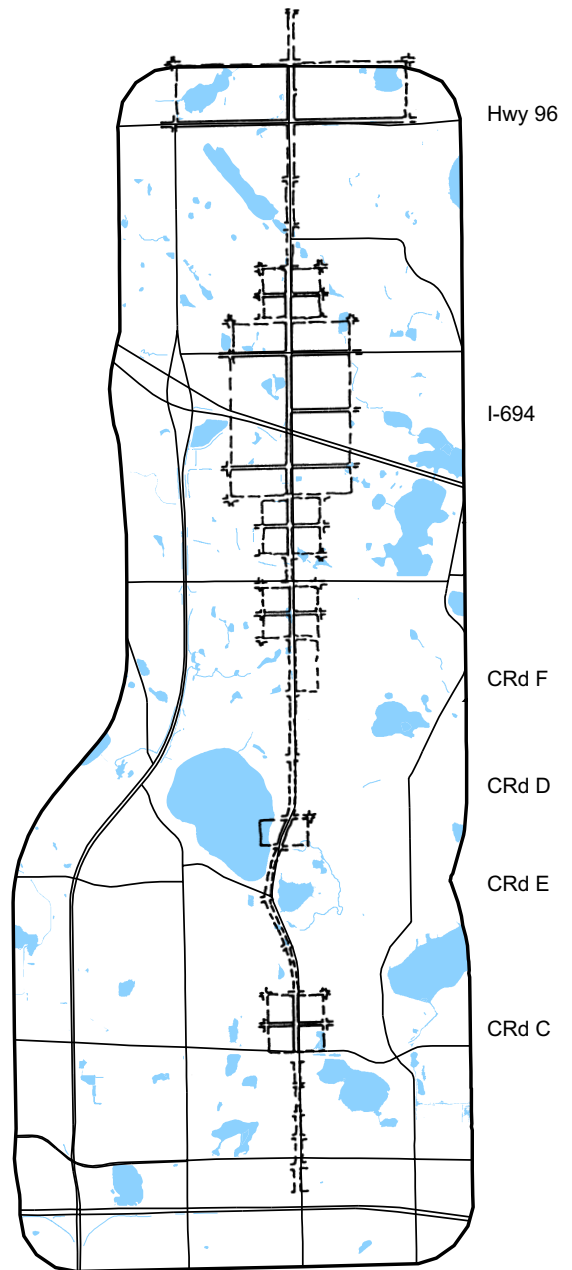
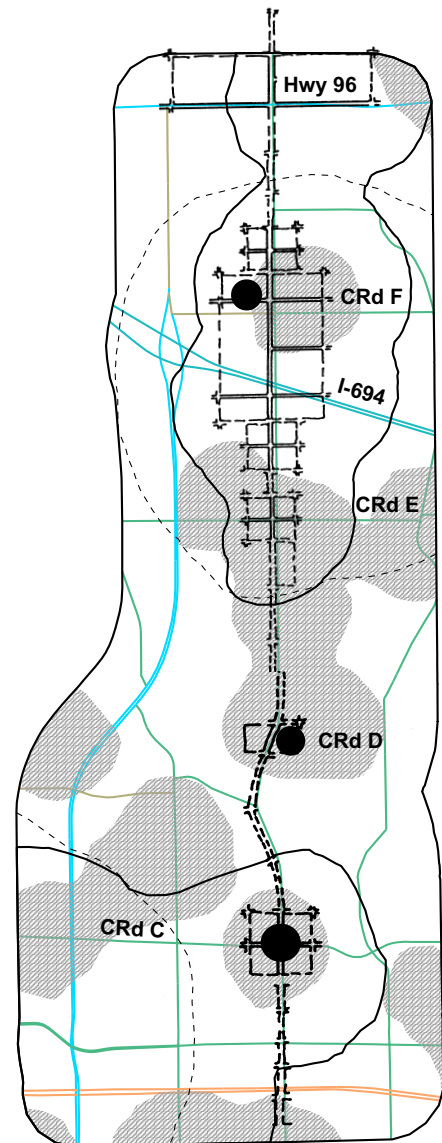

Figure 33. Road Network Redesign.

In this phase, arterial segments connecting key intersections were analyzed for land use compatibility and potential for enhancing natural systems and mobility. Information generated here was paired with information gained from applying the templates. The outcome was a network schematic that links livable places and livable arterials.

Placemaking

To illustrate how planning areas and prototypes can be reorganized into places, three intersections are studied at the street, block, and building scale. These intersections include Lexington and County Road F, a jobs and housing mix; Lexington and County Road D, a neighborhood corner; and Lexington and County Road C, a civic center linked to neighborhoods. In each case, specific livable community goals establish the program for the site, one site design option is drawn and the observations from that exercise are reported. By going through this one planning and designing iteration, it is possible to identify issues not anticipated previously, clarify feasibility questions and envision other options. These focus studies are described on the following three pages.



This diagram overlays the proposed road network redesign over activity areas. This overlay illustrates how and where redesign of activity and movement could improve operations on-the-ground. The three focus studies are at the intersections of Lexington and County Roads F, D, and C and shown with a blackdot.

Figure 34. Placemaking Case Study.

Lexington Avenue and County Road F: A Jobs and Housing Mix



Figure 35. Lexington Avenue and County Road F looking north.

Located near I-694 along a busy segment of Lexington (20,000 ADT), this is a major employment district. A variety of housing types lie northeast of the intersection and on the perimeter. Pockets of wooded areas and water bodies lay throughout the area. Land uses are segregated and access tends to be directly from the arterials.

Livable Community Goals:

- Add new jobs and homes.
- Increase connections between jobs and homes in this area.
- Create retail to leverage workers' and residents' presence.

Movement Network Strategies:

- Lexington becomes a "community boulevard" road section to create a pedestrian-oriented zone with on-street parking.
- Additional roads and designated pedestrian routes are added to increase connection to surrounding areas.
- Most commercial properties remain, with new business and retail added to fill.
- Open spaces are linked through walking routes, driving routes and new parks.

Lessons—By choosing a specific suburban character (jobs and housing), it was possible to:

- Connect the east and west halves of this area together by lowering the road speed where needed to define a walkable—and crossable—"center" area.
- Consolidate the most intense employment activities near the freeway.
- Transition from commercial areas to single-family neighborhoods while increasing connections.
- Increase residential amenities while adding significant numbers of units.

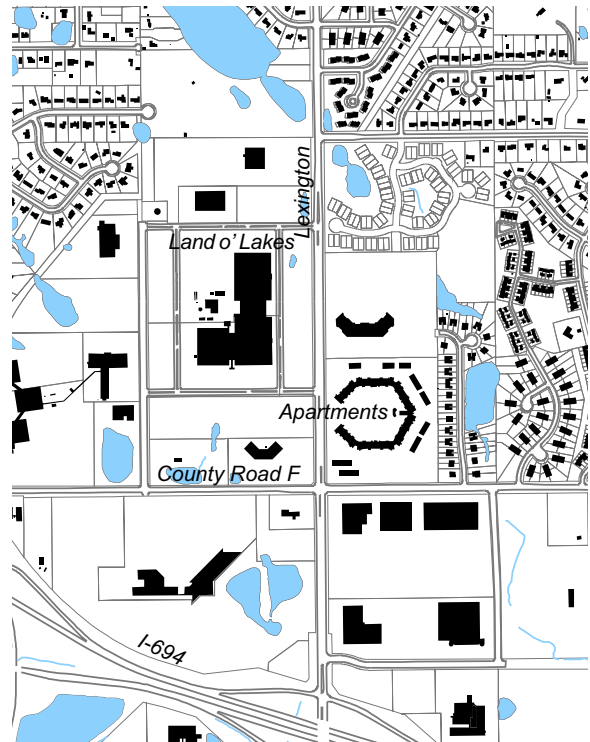

Figure 36. Existing roads, parcels, buildings, and water features (2000). Data Sources: Coalition cities, Ramsey County, PlanSight, LLC.



Figure 37. Community Boulevard Prototype.

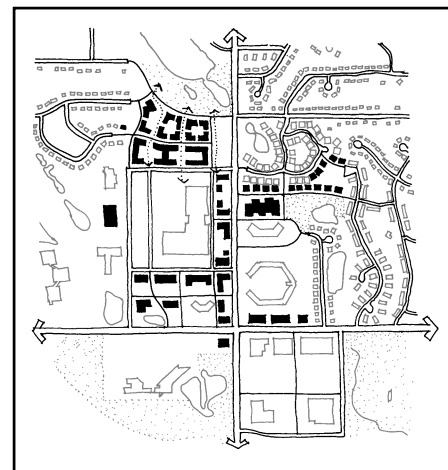

Figure 38. Schematic urban design showing proposed changes.

Lexington and County Road D: A Neighborhood Corner



Figure 39. Lexington Avenue and County Road D looking north.

Overlooking Lake Josephine and the adjacent wetland complex, this area contains a auto-oriented, mix of small-scale uses (an oil change business, small apartment buildings, and a Dairy Queen). The immediately surrounding area is mostly single family homes.

Livable Community Goals:

- Consolidate uses into a walkable neighborhood niche.
- Add new residential types and a small amount of retail.
- Improve pedestrian routes to surrounding homes and parks.

Movement Network Strategies:

- Lexington transitions from a “community boulevard” on the north to a “town center avenue” near D, to a park “community boulevard” on the south.
- Additional roads and designated pedestrian routes are added to increase connection to surrounding areas.
- Existing auto-oriented properties are replaced with a fine-grained, pedestrian-oriented mix of residential, retail and commercial.
- The wetland complex to the south is given a strong vertical edge of housing.

Lessons—In this small neighborhood corner:

- Varying the roadway design and the site layout to reflect the unique features of this place allows change to occur without losing the best qualities of the area.
- A new neighborhood image can be created by starting with a small, critical area.
- Detailed design relationships are crucial in this fine-grained intervention.



Figure 40. Existing roads, parcels, buildings, and water features (2000). Data Sources: Coalition cities, Ramsey County, PlanSight, LLC.

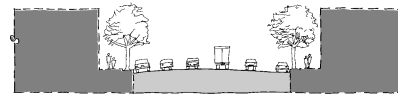

Figure 41. Town Center Avenue Prototype.

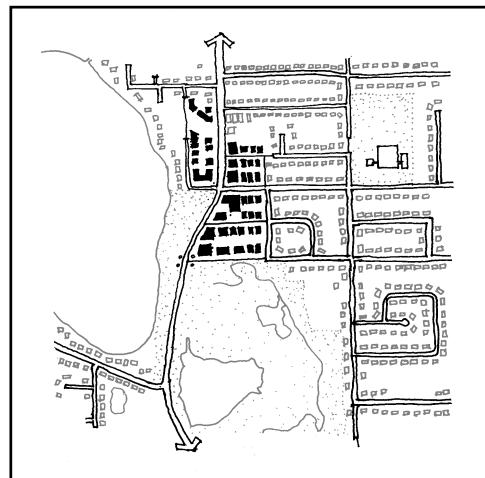

Figure 42. Schematic urban design showing proposed changes.

Lexington and County Road C: A Civic Center Linked to Neighborhoods



Figure 43. Lexington Avenue and County Road C looking north.

On a small hill, Roseville’s city hall, public offices and John Rose Ice Oval create a prominent civic image for this area. To the southeast, Central Park is a major recreation area for the city. With the other local parks and water bodies, this area’s elements can be woven together with key road and land activity changes.

Livable Community Goals:

- Add housing to leverage the significant public areas in place.
- Increase connections with local streets.
- Further define the public spaces with strong residential edges.

Movement Network Strategies:

- “Town center avenue” road section is extended north to the existing bike shop, easing access across “C”.
- New blocks are inserted northeast of the intersection, weaving into existing blocks and apartment entries.
- North of city hall, new housing bridges between existing neighborhoods and city hall.
- The wetland complex to the south is given a strong vertical edge of housing.

Lessons—In this civic intersection:

- Varying the roadway design and the site layout to reflect the unique features of this place allows change to occur without losing the best qualities of the area.
- A civic image can be strengthened by dealing with a small, critical connections.
- Quality pedestrian crossing of an arterial intersection can provide important access to amenities for residents.



Figure 44. Existing roads, parcels, buildings, and water features (2000). Data Sources: Coalition cities, Ramsey County, PlanSight, LLC.

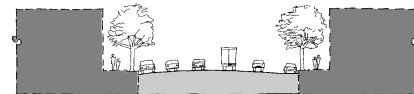

Figure 45. Town Center Avenue Prototype.

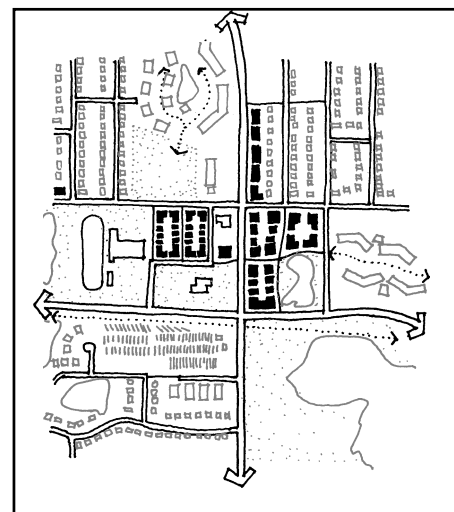

Figure 46. Schematic urban design showing proposed changes.

Subregional Network Building

Results from applying the templates and prototypes to the Lexington segment suggest there is potential to explore the feasibility of using them to build a movement and activity network across a larger geographic area. In network building, the starting point for movement is the intersection and for activity it is the planning area. There are 156 arterial intersections in the subregion, many of which have intersecting arterials of two different design speeds. Not surprisingly, there is a greater density of these intersections in the southwestern area where the arterial grid is most intense.

Laying down the template at the intersection of two arterials establishes the means for an orderly analysis of existing land uses and design speeds and the underlying contextual information. Intersections can be sorted using a matrix based on the taxonomy of templates. From this exercise, it is apparent that the greatest number of arterial intersections fall into the 45/45 m.p.h. category. Also, there is a high percentage of these intersections where land use and design speed are inconsistent. (See map on page 71.)

As these intersections are mapped, they suggest the starting point for a planning process that ultimately leads to a District Network. The planning process has several possible outcomes, each of which is dependent upon which set of criteria are optimized.

If the transportation function of the roadways and intersections is optimized, as would be the case in a conventional transportation needs analysis, then the result would be an expanded arterial system. If, instead, templates and prototypes are applied, then the result would be different. Using lessons learned from applying templates and prototypes at the segment level, the result would be an arterial system with varied design sections and compatible land uses and site designs.

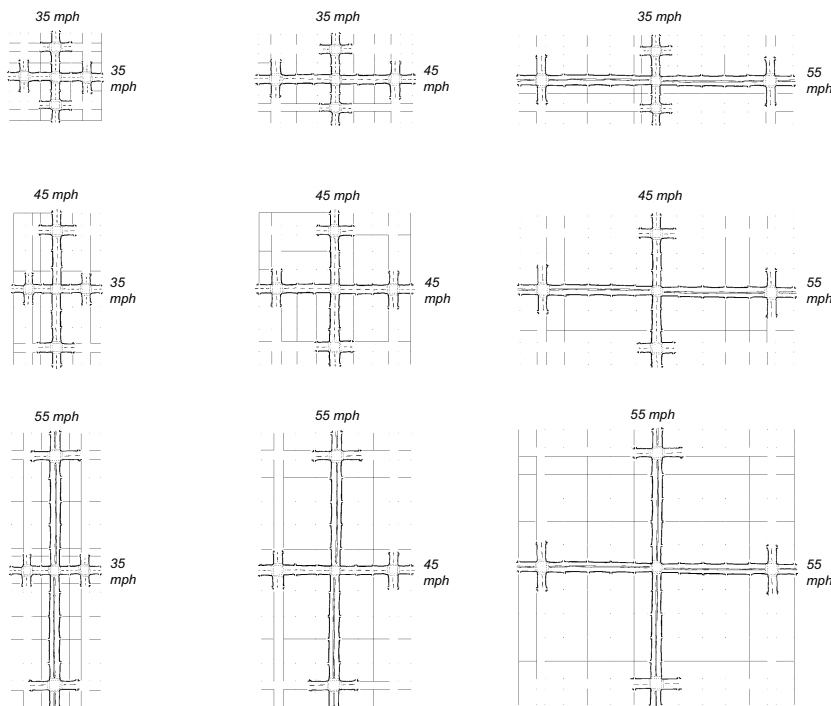
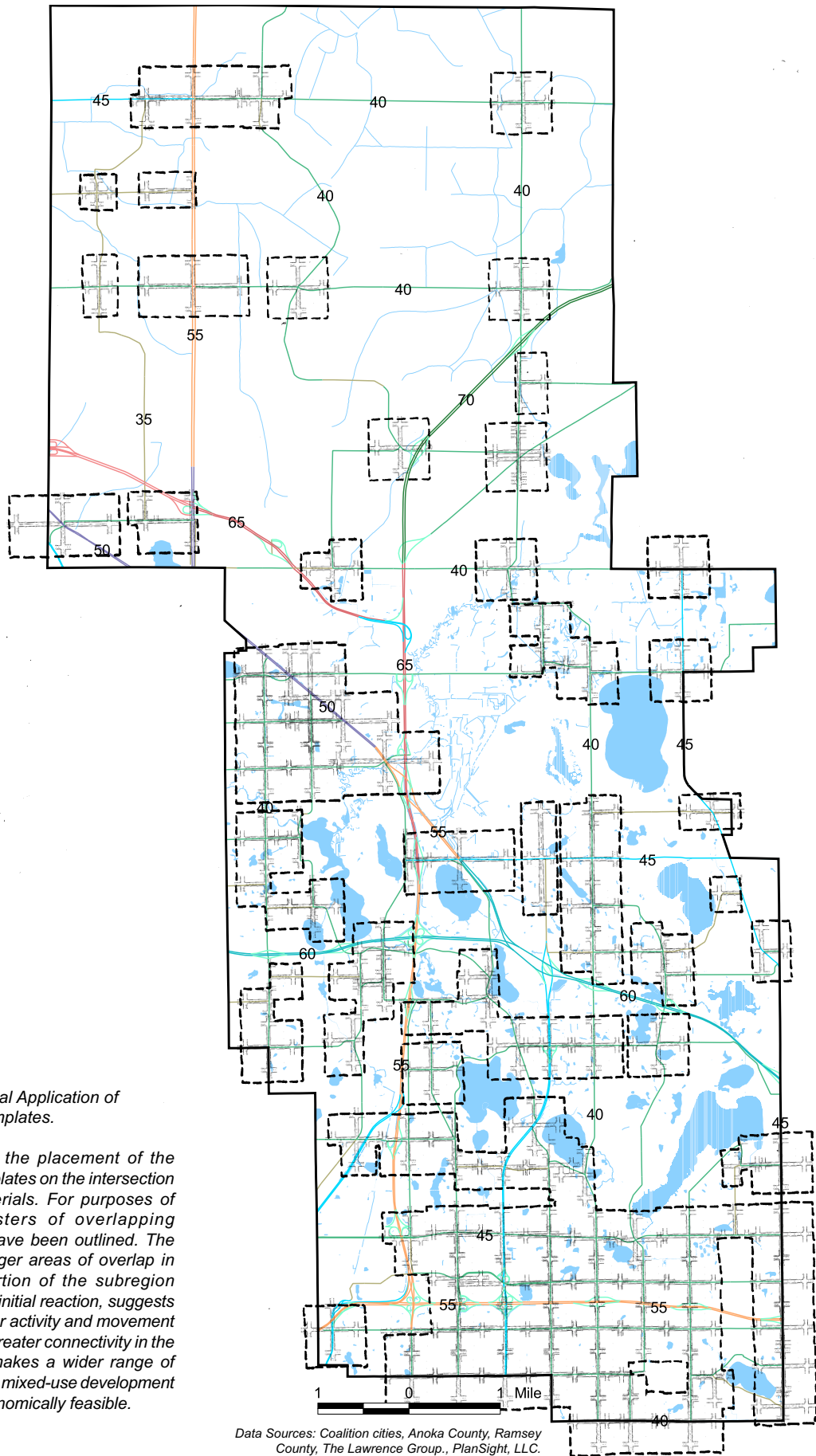

Figure 47. Urban Design Templates for Suburban Arterial Intersections.



Map 8. Subregional Application of Urban Design Templates.

This map shows the placement of the urban design templates on the intersection of two minor arterials. For purposes of readability, clusters of overlapping influence areas have been outlined. The pattern shows larger areas of overlap in the southern portion of the subregion which, contrary to initial reaction, suggests greater capacity for activity and movement because there is greater connectivity in the networks which makes a wider range of modal choices and mixed-use development projects more economically feasible.

Data Sources: Coalition cities, Anoka County, Ramsey County, The Lawrence Group., PlanSight, LLC.

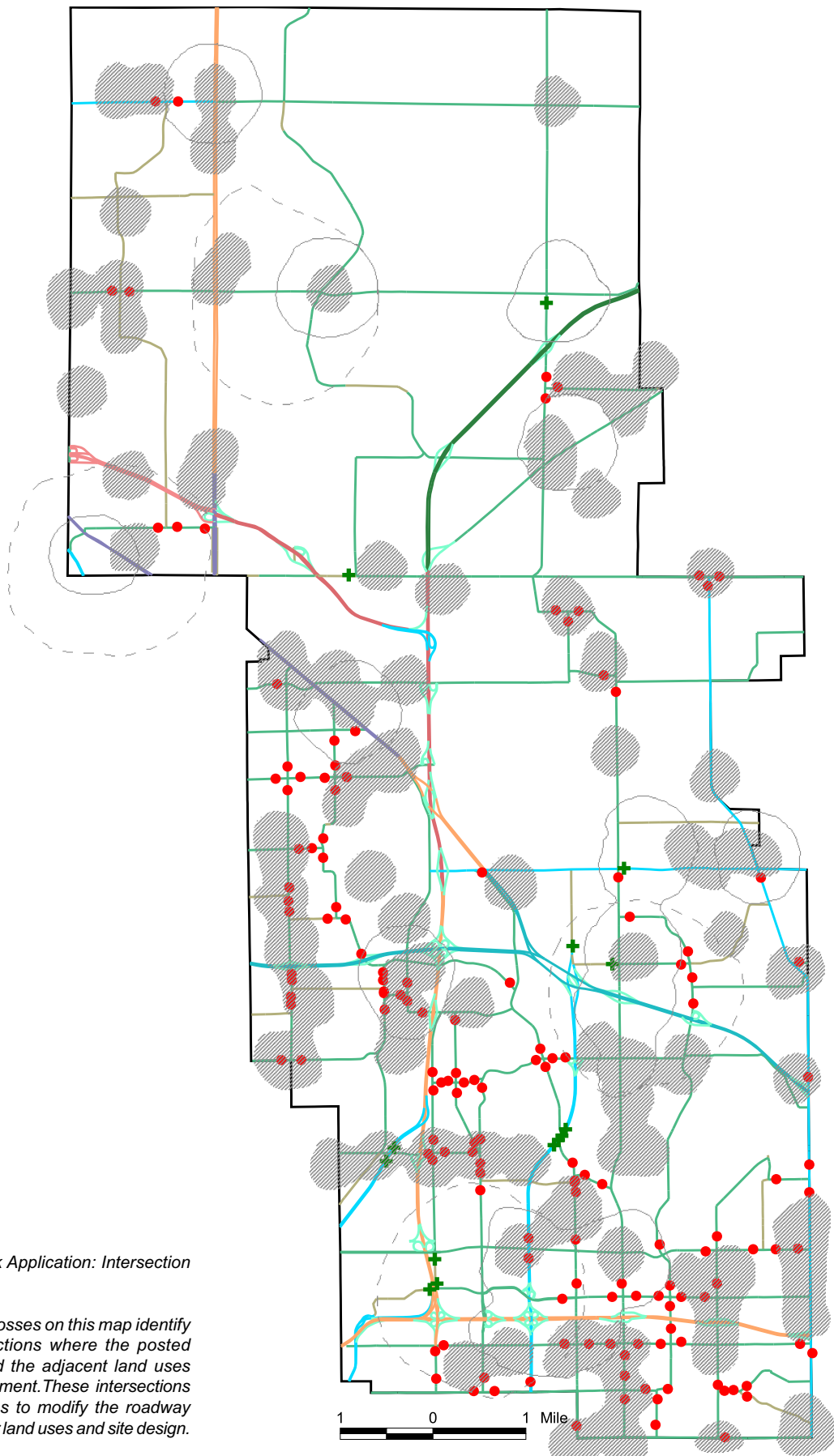

Map 9. Network Application: Intersection Analysis.

The dots and crosses on this map identify arterial intersections where the posted road speed and the adjacent land uses are not in alignment. These intersections are opportunities to modify the roadway prototype and/or land uses and site design.

Data Sources: Coalition cities, Anoka County, Ramsey County, The Lawrence Group., PlanSight, LLC.

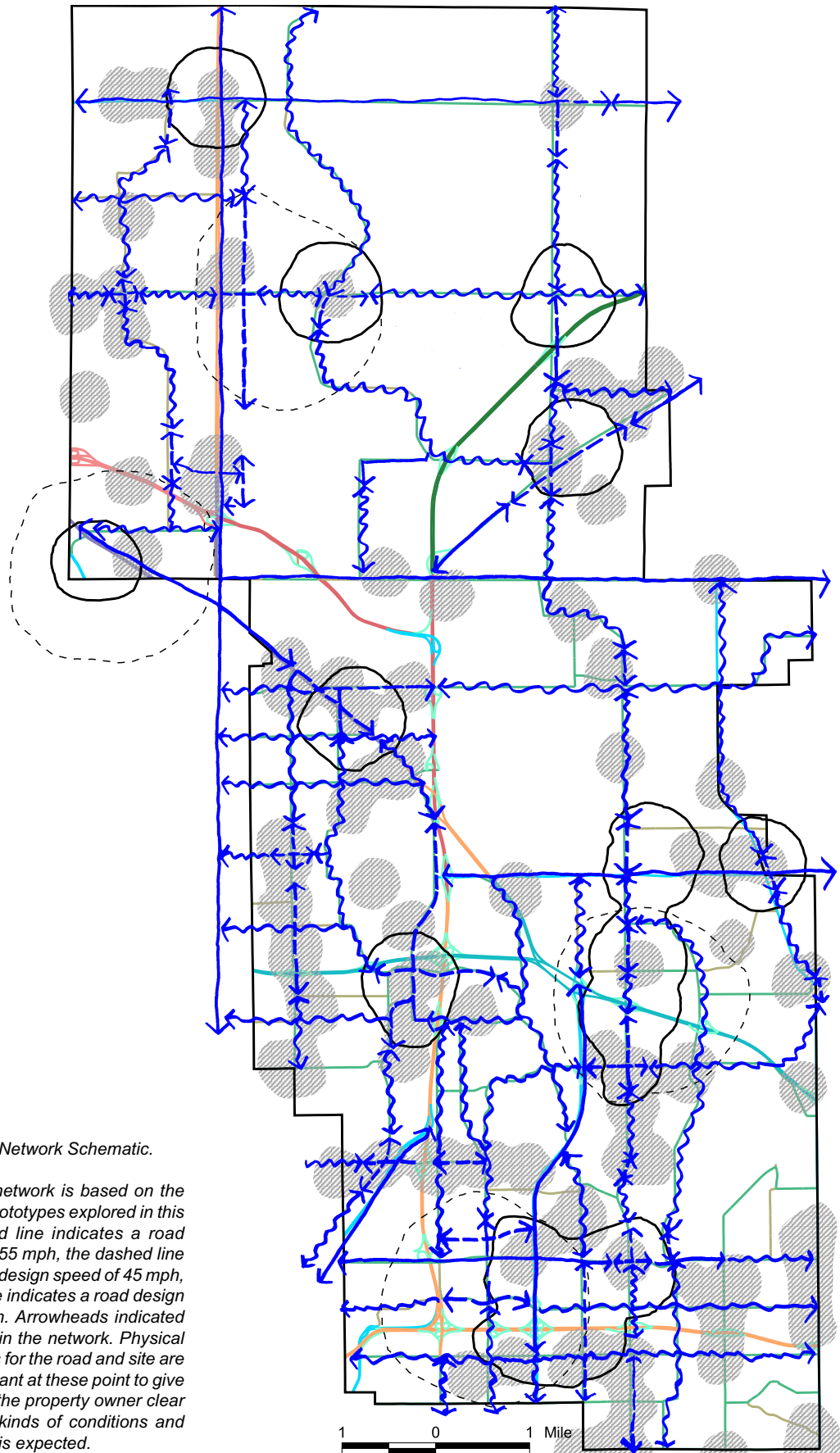

Map 10. Arterial Network Schematic.

The suggested network is based on the three roadway prototypes explored in this study. The solid line indicates a road design speed of 55 mph, the dashed line indicates a road design speed of 45 mph, and the wavy line indicates a road design speed of 35 mph. Arrowheads indicated transition points in the network. Physical design strategies for the road and site are especially important at these point to give the traveler and the property owner clear signals of what kinds of conditions and driving behavior is expected.

Data Sources: Coalition cities, Anoka County, Ramsey County, The Lawrence Group., PlanSight, LLC.

CONCLUSION



Figure 48. Silver Lake Road, New Brighton.



Figure 49. I-35W and County Road C, Roseville.

The livable suburban arterials research project set out to investigate the interaction between road section design and adjacent site design and to develop a set of design criteria that would guide alignment of land use and transportation. The research hypothesized that:

- a minimum of three arterial roadway prototypes is needed to serve travel demands and that there are three types of activity levels in suburban communities;
- district planning capabilities are desirable rather than planning roadways and sites in isolation; and
- an integrated planning approach, that is, one that gives equal consideration to land use and transportation throughout the planning process, is preferable to independent planning.

Livable community principles and urban design analytical methods provided the means to frame research questions and integrate land use and transportation.

The first component of the study generated a design framework that synthesized land use and road design into five elements that address both sides of the right-of-way. Out of these elements, three roadway prototypes and six urban design templates were developed as tools for applying the principles embedded in the design elements. The second component of the study applied the tools in a case study. The study looked at two geographic areas, a subregion composed of seven communities and a 5.5 mile arterial segment. It concluded with a proposed strategy for using the templates and prototypes to build a movement and activity network in suburban areas of a metropolitan region.

Research Findings

1. *In a District Network approach, arterials are a composite of segments designed at different speeds.*

Conventional wisdom would point toward designations of lengthy arterial segments as one roadway prototype. Research, however, revealed that frequent shifts in the type of activity centers and land uses require segments to be shorter than might be expected, especially when natural resources are taken into consideration.

2. *Spacing of controlled intersections is the critical variable that establishes the skeletal configuration of a planning area.* Once spacing requirements for different design speeds are established, access, location and basic block and building orientations are readily established. Research also demonstrates that spacing of controlled intersections is the operative linkage between the network and the site. **In other words, the spacing of these intersections is the governor that manages flow within the network and encourages activity at different points along the network.**

3. *Urban design performance criteria, when used at the beginning of the planning process, establish a qualitative standard to guide use of quantitative information.*

This finding repositions urban design from a means for mitigating the negative impacts of a road to a means for maximizing environmental and economic opportunities before a project is solidified through pre-design decisions.

4. *In the established suburban community, existing context is the mediating factor for balancing activity and movement and for phasing change in the built environment.*

This finding stems from case study work. Roadway prototypes and urban design templates, although useful as a starting point, are not the final determinants of viable opportunities. **It is the existing structures, site organization, and environmental assets that proved most insightful and informative when formulating alternative designs and consolidating network segments.**

Future Research

1. *Use a subregional transportation model to test proposed district network.*

This research project was limited to creating roadway prototypes and urban design templates for further testing. The preliminary application of prototypes and templates to Lexington Avenue demonstrated their potential, but further data is needed to probe how they might impact traffic flow and distribution and mode choice.

2. *Conduct a first phase analysis of the minor arterial network region-wide.*

The subregion selected for the case study is only three percent of the seven-county metropolitan region. The prototypes and templates would benefit from testing across a larger area that includes more variations of the basic movement and activity patterns identified in the research.

3. *Conduct segment analysis of minor arterial network region-wide.*

Once prototypes and templates have been applied regionally, the next step is to develop a regional network by identifying and combining arterial segments. A larger study area would put the concept to a more rigorous test. The research would serve as a preliminary screen before investing in a regional run of the subregional model.

4. *Conduct implementation research with focus groups.*

Converting the current arterial system to the type of network described in this research would involve the full-spectrum of agencies, governments and property owners. Staging a series of focus groups to ferret out the many implementation issues associated with the conversion. Information gathered would give a preliminary sense for the feasibility of implementing this network and would help shape strategies for change.

BIBLIOGRAPHY

- Appleyard, D. (1981). *Livable Streets*. University of California Press, Berkeley, California.
- BRW, Inc. (1999). *NM I-35W Corridor Coalition Transportation and Transit Study*. Final report prepared for the North Metro I-35W Corridor Coalition. Minneapolis, Minnesota.
- Beimborn, E. and H. Rabinowitz. (1991). *Guidelines for Transit Sensitive Suburban Land Use Design*. U.S. Department of Transportation, Washington, D.C.
- Bishop, K.R. (1989). *Designing Urban Corridors*. Planning Advisory Service Report 418. American Planning Association, Chicago, Illinois.
- Calthorpe, P. (1993). *The Next American Metropolis: Ecology, Community and the American Dream*. Princeton Architectural Press, New York, New York.
- Calthorpe, P. et al. (March 1997). *Design for Efficient Suburban Activity Centers*. U.S. Department of Transportation and Federal Transit Administration.
- Cervero, R. (1986). *America's Suburban Centers: The Land-Use Transportation Link*. Unwin-Hyman, Boston, Massachusetts.
- City of Seattle. (May 1996). *Making Streets that Work*. Seattle, Washington.
- Colorado, State of. (August 1998). *State Highway Access Code, Volume 2, Code of Colorado Regulations 601-1*.
- Deakin, E. (1988). "Issues and Opportunities for Transit: An Exploration of Changes in the External Environment and Land Use and Development Trends." A background paper prepared for APTA Transit 2000 Task Force.
- Deakin, E. (1991). Jobs, Housing and Transportation: Theory and Evidence on Interactions Between Land Use and Transportation. *Transportation, Urban Form and the Environment*. Special Report 231. Transportation Research Board National Research Council, Washington, D.C.
- Design Center for American Urban Landscape. (April 2000). *Engaging Local Communities for Regional Change*. Final report prepared for the North Metro I-35W Corridor Coalition. College of Architecture and Landscape Architecture, University of Minnesota, Minneapolis, Minnesota.
- Design Center for American Urban Landscape. (May 1998). *I-35W Corridor Coalition Comprehensive Livable Community Urban Design and Transportation Study*. Final report prepared for the North Metro I-35W Corridor Coalition. College of Architecture and Landscape Architecture, University of Minnesota, Minneapolis, Minnesota.
- Design Center for American Urban Landscape. (2000). *Subregional Growth Study 2000 - 2020, Build-out Workshop Reports 1 & 2*. Prepared for the North Metro I-35W Corridor Coalition. College of Architecture and Landscape Architecture, University of Minnesota, Minneapolis, Minnesota.
- Dotterrer, Steve. (1987). "Portland's Arterial Streets Classification Policy." In *Public Streets for Public Use*, Anne Vernez Moudon, ed. Columbia University Press, New York.
- Douglas, G.B., III, and J.E. Evans. (1997). *Urban Design, Urban Form, and Employee Travel Behavior*. Presented at the 1997 Sixth TRB Conference on the Application of Transportation Planning Methods, Dearborn, Michigan.
- Dyett, M. (1991). Site Design and Its Relation to Urban Form. *Transportation, Urban Form and the Environment*. Transportation Research Board Special Report 231. Transportation Research Board National Research Council: Washington, D.C.
- Eager, W. R. (1993). *Accommodating Land Use and Transportation Planning. Land Use in Transition*. Urban Land Institute.

- Ewing, R. (1997). *Transportation and Land Use Innovations When you Can't Pave your Way out of Congestion*. American Planning Association, Planners Press, Chicago, IL.
- Ewing, R., P. Haliyur, and G. W. Page (1994). Getting Around a Traditional City, a Suburban Planned Unit Development, and Everything in Between. *Transportation Research Record* 1466.
- Federal Transit Administration. (1999). *Building Livable Communities with Transit: Planning, Development, and Implementing Community-sensitive Transit*. Washington, D.C.
- Frank, L.D. and G. Pivo. (1994). Impacts of Mixed Use and Density on Utilization of Three Modes of Travel: Single-Occupant Vehicle, Transit, and Walking. *Transportation Research Record* 1466.
- Friedman, B., S. Gordon and J. Peers. (1994). *Effect of Neotraditional Design on Travel Characteristics*. Transportation Research Record 1466.
- Handy, S. (1993). Regional Versus Local Accessibility: Implications for Nonwork Travel. *Transportation Research Record* 1400.
- Handy, S. (1996). Urban Form and Pedestrian Choices: Study of Austin Neighborhoods. *Transportation Research Record* 1552.
- Hess, P., A.V. Moudon, M. C. Snyder, and K. Stanilov. (1999). *Site Design and Pedestrian Travel*. Presented at the 1999 Transportation Research Board Conference, Washington, D.C. (Paper#990424).
- Hennepin County Department of Public Works, Transportation Division. (April 1995). *Recommended Urban Landscape/Streetscape Guidelines*. Minneapolis, Minnesota.
- Kelbaugh, D. et al. (1989). *The Pedestrian pocket Book: A New Suburban Design Strategy*. Princeton Architectural Press, New York.
- King, M., T. Williams, R. Ewing. (January 2001). State Flexing Main Street Design: a report on efforts by various states to 'flex' their highway standards toward better main street design. Transportation Research Board Annual Meeting Pre-prints.
- Kulash, W. (1990). Neotraditional Town Planning, "Will Traffic Work." Session Notes, Planners Training Service, Chicago, Illinois.
- McLeod, D. S. (1996). Integrating Transportation and Environmental Planning: Extending Applicability of Corridor and Subarea Studies and Decisions on Design Concept and Scope. *Transportation Research Record* 1552.
- McNally, M. and A. Kulkarni. (1997). An Assessment of the Land Use-Transportation System and Travel Behavior. *Transportation Research Record* 1607.
- McNally, M. and S. Ryan. (1993). Comparative Assessment of Travel Characteristics for Neotraditional Designs. *Transportation Research Record* 1400.
- MSM Regional Council (1991). *The Impact of Various Land Use Strategies on Suburban Mobility*.
- Metro Regional Services. (November 1997). *Creating Livable Streets: Street Design Guidelines for 2040*. Portland.
- Minnesota Department of Transportation. (February 2001). *Access Categories and Spacing Guidelines, Technical Background*.
- Minnesota Department of Transportation. (as amended through January 1999). *Minnesota Manual on Uniform Traffic Control Devices*.

- Minnesota Department of Transportation. (as amended through July 25, 2000). *Road Design English Manual, Part I & Part II*.
- Minnesota, State of (Current as of 07/21/00). *Minnesota Rules Chapter 8820, Department of Transportation, Local State-Aid Route Standards, Financing*. Office of the Reviser of Statutes.
- Nevada Department of Transportation. (July 1999). *Access Management System and Standards*.
- Obermayer, S. J. (1994). *Integrating Transportation and Land Use Planning*. Texas Transportation Institute. Texas A & M University System, College Station, Texas.
- Oregon Department of Transportation. (November 1999). *Main Street...when a highway runs through it: A Handbook for Oregon Communities*.
- 1000 Friends of Oregon. (1991-1997). *Making the Land Use, Transportation, Air Quality Connection*. Vol. 1-8. and *Site Design and Travel Behavior: A Bibliography*. (1993) 1000 Friends of Oregon, Portland, OR.
- Parsons, Brinckerhoff, Quade & Douglas Inc. (1999). *Land Use Impacts of Transportation: A Guidebook*. National Academy Press, Washington, D.C.
- Parsons, Brinckerhoff, Quade & Douglas, Inc. (1996). *Transit and Urban Form*. Vol. 1 & 2. Report 16 of the Transit Cooperative Research Program, Transportation Research Board National Research Council. National Academy Press, Washington, D.C.
- Petkov, M. and B.C. Scheet. (1998). *Edge City Morphology: A Comparison of Commercial Centers*. *Journal of the American Planning Association*, Vol. 64: p. 298-310.
- Pivo, G. (1997). *How Do You Implement Less Auto-Dependent Urban Form?* Research Report, WA-RD 436.1.
- Pivo, G. et al. (1992). *A Summary of Guidelines for Coordinated Urban Design, Transportation and Land Use Planning, with an Emphasis on Encouraging Alternatives to Driving Alone*. Prepared for the Washington State Transportation Commission.
- Portland Metro. (1996). *Regional Street Design Policies*. Summary from Council Resolution on July 1996 Regional Transportation Plan Policies.
- Rabinowitz, H. et al. (1991). *The New Suburb*. U.S. Department of Transportation.
- Sen, S. (1999). *Toward a Typology of Transportation-Related Urban Design Problems and Solutions: Case Studies of Small and Medium Sized Cities in the Eastern United States*. National Transportation Center.
- Skidmore, Owing & Merrill et al. (1994). *Planning for Transit-Friendly Land Use: A Handbook for New Jersey Communities*. Federal Transit Administration, Washington, D.C.
- Snohomish County Transportation Authority. (1989,1993). *A Guide to Land Use and Public Transportation for Snohomish County, Washington*. Vol. I. and *A Guide to Land Use and Public Transportation: Applying the Concepts*. Vol. II. Lynwood, WA.
- Transit Cooperative Research Program. (1996). Part I. *Transit, Urban Form and the Built Environment: A Summary of Knowledge and Part III. A guidebook for Practitioners*. TCRP Project H-1: *Transit and Urban Form*. Vol. 1. and 2. Transportation Research Board, National Academy Press, Washington, D.C.
- Tri-Met. (1993). *Planning and Design for Transit*. Tri-County Metropolitan Transportation District of Oregon.

Transportation Research Board. (1997). *Determination of Stopping Sight Distance*, National Cooperative Highway Research Program Report 400.

Transportation Research Board. (1999). *Impacts of Access Management Techniques*, National Cooperative Highway Research Program Report 420.

Transportation Research Board. (March 1996). *Driveway and Street Intersection Spacing*, Transportation Research Circular Number 426.

Untermann, R. (1991). *Linking Land Use and Transportation: Design Strategies to Serve HOVs and Pedestrians*. Prepared for the Washington State Transportation Commission.

Untermann, R. (1990). Streets are for Sharing. *Landscape Architecture* (July 1990).

Urbitran Associates, Inc., Multisystems, Inc., SG Association, Inc., and Robert Cervero. (November 1999). *Guidelines for Enhancing Suburban Mobility Using Public Transportation*. Report 55 of the Transit Cooperative Research Program, Transportation Research Board National Research Council. National Academy Press, Washington, D.C.

US Architectural and Transportation Barriers Compliance Board. (November, 1999). *Accessible Rights-of-Way: A Design Guide*. Washington, D.C.

US Department of Transportation, Federal Highway Administration. (September 1997). *Flexibility in Highway Design*. Washington, D.C.

Western Australian Government Sustainable Cities Initiative. (December 1997). *Liveable Neighbourhoods Community Design Code*. Perth.